

ViewSonic®



PJD5132/PJD5232L/PJD5134/ PJD5234L/PJD5533w DLP Projector User Guide

IMPORTANT: Please read this User Guide to obtain important information on installing and using your product in a safe manner, as well as registering your product for future service. Warranty information contained in this User Guide will describe your limited coverage from ViewSonic Corporation, which is also found on our web site at <http://www.viewsonic.com> in English, or in specific languages using the Regional selection box in the upper right corner of our website. "Antes de operar su equipo lea cuidadosamente las instrucciones en este manual"

Model No. VS14926/VS14929/VS14928/VS14930/VS14117

Compliance Information

FCC Statement

This device complies with part 15 of FCC Rules. Operation is subject to the following two conditions: (1) this device may not cause harmful interference, and (2) this device must accept any interference received, including interference that may cause undesired operation.

This equipment has been tested and found to comply with the limits for a Class B digital device, pursuant to part 15 of the FCC Rules. These limits are designed to provide reasonable protection against harmful interference in a residential installation. This equipment generates, uses, and can radiate radio frequency energy, and if not installed and used in accordance with the instructions, may cause harmful interference to radio communications. However, there is no guarantee that interference will not occur in a particular installation. If this equipment does cause harmful interference to radio or television reception, which can be determined by turning the equipment off and on, the user is encouraged to try to correct the interference by one or more of the following measures:

- Reorient or relocate the receiving antenna.
- Increase the separation between the equipment and receiver.
- Connect the equipment into an outlet on a circuit different from that to which the receiver is connected.
- Consult the dealer or an experienced radio/TV technician for help.

Warning: You are cautioned that changes or modifications not expressly approved by the party responsible for compliance could void your authority to operate the equipment.

For Canada

- This Class B digital apparatus complies with Canadian ICES-003.
- Cet appareil numérique de la classe B est conforme à la norme NMB-003 du Canada.

CE Conformity for European Countries

 The device complies with the EMC Directive 2004/108/EC and Low Voltage Directive 2006/95/EC.

Following information is only for EU-member states:

The mark is in compliance with the Waste Electrical and Electronic Equipment Directive 2002/96/EC (WEEE).

The mark indicates the requirement NOT to dispose the equipment including any spent or discarded batteries or accumulators as unsorted municipal waste, but use the return and collection systems available.

If the batteries, accumulators and button cells included with this equipment, display the chemical symbol Hg, Cd, or Pb, then it means that the battery has a heavy metal content of more than 0.0005% Mercury or more than, 0.002% Cadmium, or more than 0.004% Lead.



Important Safety Instructions

1. Read these instructions.
2. Keep these instructions.
3. Heed all warnings.
4. Follow all instructions.
5. Do not use this unit near water.
6. Clean with a soft, dry cloth.
7. Do not block any ventilation openings. Install the unit in accordance with the manufacturer's instructions.
8. Do not install near any heat sources such as radiators, heat registers, stoves, or other devices (including amplifiers) that produce heat.
9. Do not defeat the safety purpose of the polarized or grounding-type plug. A polarized plug has two blades with one wider than the other. A grounding type plug has two blades and a third grounding prong. The wide blade and the third prong are provided for your safety. If the provided plug does not fit into your outlet, consult an electrician for replacement of the obsolete outlet.
10. Protect the power cord from being walked on or pinched particularly at plugs. Convenience receptacles and the point where they exit from the unit. Be sure that the power outlet is located near the unit so that it is easily accessible.
11. Only use attachments/accessories specified by the manufacturer.
12. Use only with the cart, stand, tripod, bracket, or table specified by the manufacturer, or sold with the unit. When a cart is used, use caution when moving the cart/unit combination to avoid injury from tipping over. 
13. Unplug this unit when unused for long periods of time.
14. Refer all servicing to qualified service personnel. Servicing is required when the unit has been damaged in any way, such as: if the power-supply cord or plug is damaged, if liquid is spilled onto or objects fall into the unit, if the unit is exposed to rain or moisture, or if the unit does not operate normally or has been dropped.

Declaration of RoHS Compliance

This product has been designed and manufactured in compliance with Directive 2002/95/EC of the European Parliament and the Council on restriction of the use of certain hazardous substances in electrical and electronic equipment (RoHS Directive) and is deemed to comply with the maximum concentration values issued by the European Technical Adaptation Committee (TAC) as shown below:

Substance	Proposed Maximum Concentration	Actual Concentration
Lead (Pb)	0.1%	< 0.1%
Cadmium (Cd)	0.01%	< 0.01%
Hexavalent Chromium (Cr ⁶⁺)	0.1%	< 0.1%
Polybrominated biphenyls (PBB)	0.1%	< 0.1%
Polybrominated diphenyl ethers (PBDE)	0.1%	< 0.1%

Certain components of products as stated above are exempted under the Annex of the RoHS Directives as noted below:

Examples of exempted components are:

1. Lead in glass of cathode ray tubes, electronic components, fluorescent tubes, and electronic ceramic parts (e.g. piezoelectric devices).
2. Lead in high temperature type solders (i.e. lead-based alloys containing 85% by weight or more lead).
3. Lead as an alloying element in steel containing up to 0.35% lead by weight, aluminium containing up to 0.4% lead by weight and as a copper alloy containing up to 4% lead by weight.

Copyright Information

Copyright © ViewSonic® Corporation, 2012. All rights reserved.

Macintosh and Power Macintosh are registered trademarks of Apple Inc.

Microsoft, Windows, Windows NT, and the Windows logo are registered trademarks of Microsoft Corporation in the United States and other countries.

ViewSonic, the three birds logo, OnView, ViewMatch, and ViewMeter are registered trademarks of ViewSonic Corporation.

VESA is a registered trademark of the Video Electronics Standards Association. DPMS and DDC are trademarks of VESA.

PS/2, VGA and XGA are registered trademarks of International Business Machines Corporation.

Disclaimer: ViewSonic Corporation shall not be liable for technical or editorial errors or omissions contained herein; nor for incidental or consequential damages resulting from furnishing this material, or the performance or use of this product.

In the interest of continuing product improvement, ViewSonic Corporation reserves the right to change product specifications without notice. Information in this document may change without notice.

No part of this document may be copied, reproduced, or transmitted by any means, for any purpose without prior written permission from ViewSonic Corporation.

Product Registration

To meet your future needs, and to receive any additional product information as it becomes available, please register your product on the Internet at: www.viewsonic.com. The ViewSonic® Wizard CD-ROM also provides an opportunity for you to print the registration form, which you may mail or fax to ViewSonic.

For Your Records

Product Name:	PJD5132/PJD5232L/PJD5134/PJD5234L/PJD5533w ViewSonic DLP Projector
Model Number:	VS14926/VS14929/VS14928/VS14930/VS14117
Document Number:	PJD5132/PJD5232L/PJD5134/PJD5234L/PJD5533w_ UG_ENG Rev. 1A 11-21-12
Serial Number:	_____
Purchase Date:	_____

Product disposal at end of product life

The lamp in this product contains mercury which can be dangerous to you and the environment. Please use care and dispose of in accordance with local, state or federal laws.

ViewSonic respects the environment and is committed to working and living green. Thank you for being part of Smarter, Greener Computing. Please visit ViewSonic website to learn more.

USA & Canada: <http://www.viewsonic.com/company/green/recycle-program/>

Europe: <http://www.viewsoniceurope.com/uk/support/recycling-information/>

Taiwan: <http://recycle.epa.gov.tw/recycle/index2.aspx>

Table of contents

Important safety instructions	2
Introduction	4
Projector features	4
Shipping contents	5
Projector exterior view	6
Controls and functions	7
Positioning your projector	12
Choosing a location	12
Projection dimensions	13
Connection	15
Connecting a computer or monitor	16
Connecting Video source devices	17
Operation	20
Starting up the projector	20
Using the menus	21
Utilizing the password function	22
Switching input signal	25
Adjusting the projected image	26
Magnifying and searching for details ..	27
Selecting the aspect ratio	28
Optimizing the image	31
Setting the presentation timer	35
Hiding the image	36
Locking control keys	36
Freezing the image	36
Operating in a high altitude environment ..	36
Using the CEC function	37
Using the 3D functions	37

Using the projector in standby mode ..	38
Shutting down the projector	39
Menu operation	40
Maintenance	50
Care of the projector	50
Lamp information	51
Troubleshooting	57
Specifications	58
Projector specifications	58
Dimensions	60
Ceiling mount installation	60
Timing chart	61
Copyright information ..	63
Appendix	64
IR control table	64
RS232 command table	66

Important safety instructions

Your projector is designed and tested to meet the latest standards for safety of information technology equipment. However, to ensure safe use of this product, it is important that you follow the instructions mentioned in this manual and marked on the product.

Safety Instructions

1. **Please read this manual before you operate your projector.** Save it for future reference.
2. **Do not look straight at the projector lens during operation.** The intense light beam may damage your eyes.
3. **Refer servicing to qualified service personnel.**
4. **Always open the lens shutter or remove the lens cap when the projector lamp is on.**
5. In some countries, the line voltage is NOT stable. This projector is designed to operate safely within a mains voltage between 100 to 240 volts AC, but could fail if power cuts or surges of ± 10 volts occur. **In areas where the mains voltage may fluctuate or cut out, it is recommended that you connect your projector through a power stabilizer, surge protector or uninterruptible power supply (UPS).**
6. Do not block the projection lens with any objects when the projector is under operation as this could cause the objects to become heated and deformed or even cause a fire. To temporarily turn off the lamp, press BLANK on the projector or remote control.
7. The lamp becomes extremely hot during operation. Allow the projector to cool for approximately 45 minutes prior to removing the lamp assembly for replacement.
8. Do not operate lamps beyond the rated lamp life. Excessive operation of lamps beyond the rated life could cause them to break on rare occasions.
9. Never replace the lamp assembly or any electronic components unless the projector is unplugged.
10. Do not place this product on an unstable cart, stand, or table. The product may fall, sustaining serious damage.
11. Do not attempt to disassemble this projector. There are dangerous high voltages inside which may cause death if you should come into contact with live parts. The only user serviceable part is the lamp which has its own removable cover.
Under no circumstances should you ever undo or remove any other covers. Refer servicing only to suitably qualified professional service personnel.
12. Do not place this projector in any of the following environments.
 - Space that is poorly ventilated or confined. Allow at least 50 cm clearance from walls and free flow of air around the projector.
 - Locations where temperatures may become excessively high, such as the inside of a car with all windows rolled up.
 - Locations where excessive humidity, dust, or cigarette smoke may contaminate optical components, shortening the projector's life span and darkening the picture.
 - Locations near fire alarms
 - Locations with an ambient temperature above 40°C / 104°F
 - Locations where the altitudes are higher than 3000 m (10000 feet).

13. Do not block the ventilation holes. If the ventilation holes are seriously obstructed, overheating inside the projector may result in a fire.
 - Do not place this projector on a blanket, bedding or any other soft surface.
 - Do not cover this projector with a cloth or any other item.
 - Do not place inflammables near the projector.
14. Always place the projector on a level, horizontal surface during operation.
 - Do not use if tilted at an angle of more than 10 degrees left to right, nor at angle of more than 15 degrees front to back. Using the projector when it is not fully horizontal may cause a malfunction of, or damage to, the lamp.
15. Do not stand the projector on end vertically. Doing so may cause the projector to fall over, causing injury or resulting in damage to the projector.
16. Do not step on the projector or place any objects upon it. Besides probable physical damage to the projector, doing so may result in accidents and possible injury.
17. Do not place liquids near or on the projector. Liquids spilled into the projector may cause it to fail. If the projector does become wet, disconnect it from the power supply's wall socket and call your local service center to have the projector serviced.
18. This product is capable of displaying inverted pictures for ceiling mount installation.
 -  **Use only qualified ceiling mount kit for mounting the projector and ensure it is securely installed.**
19. When the projector is under operation, you may sense some heated air and odor from its ventilation grill. It is a normal phenomenon and not a product defect.
20. Do not use the Security bar for transporting or installation. It should be used with a commercially available theft prevention cable.

Safety instructions for ceiling mounting of the projector

We want you to have a pleasant experience using your projector, so we need to bring this safety matter to your attention to prevent damage to person and property.

If you intend to mount your projector on the ceiling, we strongly recommend that you use a proper fitting projector ceiling mount kit and that you ensure it is securely and safely installed.

If you use an inappropriate projector ceiling mount kit, there is a safety risk that the projector may fall from the ceiling due to an improper attachment through the use of the wrong gauge or length screws.

You can purchase a projector ceiling mount kit from the place you purchased your projector. We recommends that you also purchase a separate Kensington lock compatible security cable and attach it securely to both the Kensington lock slot on the projector and the base of the ceiling mount bracket. This will perform the secondary role of restraining the projector should its attachment to the mounting bracket become loose.

Introduction

Projector features

The projector integrates high-performance optical engine projection and a user-friendly design to deliver high reliability and ease of use.

The projector offers the following features.

- Dynamic PC and Dynamic Movie functions adjusting the power consumption of the lamp according to the brightness of the image being projected
 - DynamicEco Timer function decreasing the power consumption of the lamp by up to 30% when no input signal can be detected for a set period of time.
 - Presentation timer for better control of time during presentations
 - Supports 3D display
 - Color Management allowing color adjustments to your liking
 - Less than 0.5W power consumption when power saving mode is turned on
 - Screen Color correction allowing projection on surfaces of several predefined colors
 - Quick auto search speeding up the signal detecting process
 - Color and Reference modes providing choices for different projection purposes
 - Selectable quick power off function
 - One-key auto-adjustment to display the best picture quality
 - Digital keystone correction to correct distorted images
 - Adjustable color management control for data/video display
 - Ability to display 1.07 billion colors
 - Multi-language On-Screen Display (OSD) menus
 - Switchable normal and economic modes to reduce the power consumption
 - Component HDTV compatibility (YPbPr)
 - HDMI CEC (Consumer Electronics Control) function allows synchronized power ON/OFF operation between the projector and a CEC-compatible device connected to the HDMI input of the projector (PJD5134/PJD5234L/PJD5533w models only)
-  • **The apparent brightness of the projected image will vary depending on the ambient lighting conditions, selected input signal contrast/brightness settings, and is directly proportional to projection distance.**
- **The lamp brightness will decline over time and may vary within the lamp manufacturers specifications. This is normal and expected behavior.**

Shipping contents

Carefully unpack and verify that you have all of the items shown below. If any of these items are missing, please contact your place of purchase.

Standard accessories

 The supplied accessories will be suitable for your region, and may differ from those illustrated.

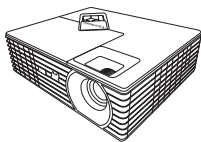

Projector

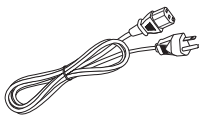

Power Cord

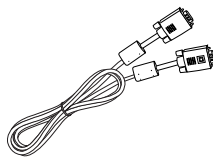

VGA Cable



Multi-language user
manual DVD



Quick Start Guide

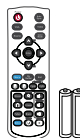

Remote Control & Batteries

Optional accessories

1. Replacement lamp
2. Soft carry case
3. VGA-Component adapter

Projector exterior view

Front/upper side

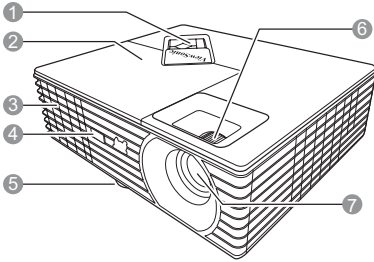

Rear/lower side

PJD5132/PJD5232L

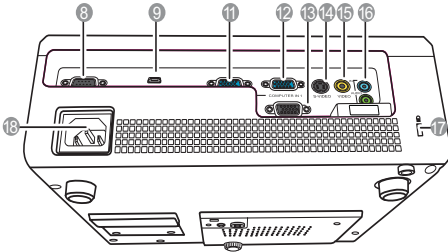

PJD5134/PJD5234L/PJD5533w

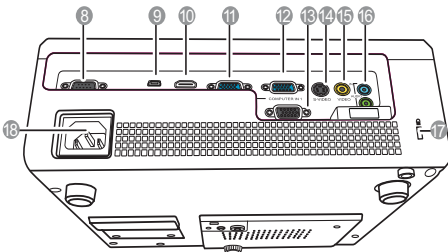

1. External control panel
(See "Projector" on page 7 for details.)
2. Lamp cover
3. Vent (heated air exhaust)
4. Front IR remote sensor
5. Adjuster foot
6. Focus and Zoom rings
7. Projection lens
8. RS-232 control port
9. Type B USB port
10. HDMI port
11. RGB (PC)/Component video (YPbPr/YCbCr) signal input socket-2
12. RGB (PC)/Component video (YPbPr/YCbCr) signal input socket-1
13. RGB signal output socket
14. S-Video input socket
15. Video input socket
16. Audio signal input socket
Audio signal output socket
17. Kensington anti-theft lock slot
18. AC power cord inlet

⚠ Warning

- THIS APPARATUS MUST BE EARTHED.
- When installing the unit, incorporate a readily accessible disconnect device in the fixed wiring, or connect the power plug to an easily accessible socket-outlet near the unit. If a fault should occur during operation of the unit, operate the disconnect device to switch the power supply off, or disconnect the power plug.

Controls and functions

Projector

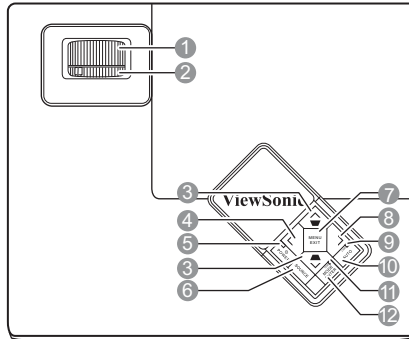

- 1. Focus ring**
Adjusts the focus of the projected image.
- 2. Zoom ring**
Adjusts the size of the image.
- 3. Keystone/Arrow keys (▾ / ^ Up, ▴ / ▾ Down)**
Manually corrects distorted images resulting from an angled projection.
- 4. < Left/Blank**
Hides the screen picture.
- 5. POWER indicator light**
Lights up or flashes when the projector is under operation.
 **POWER**
Toggles the projector between standby mode and on.
- 6. SOURCE**
Displays the source selection bar.
- 7. MENU/EXIT**
Turns on the On-Screen Display (OSD) menu. Goes back to previous OSD menu, exits and saves menu settings.
- 8. > Right**
Activates panel key lock.
When the On-Screen Display (OSD) menu is activated, the #3, #4, and #8 keys are used as directional arrows to select the desired menu items and to make adjustments.
- 9. LAMP indicator light**
Indicates the status of the lamp. Lights up or flashes when the lamp has developed a problem.
- 10. AUTO**
Automatically determines the best picture timings for the displayed image.
- 11. TEMPERATURE indicator light**
Lights up red if the projector's temperature becomes too high.
- 12. MODE/ENTER**
Selects an available picture setup mode.
Enacts the selected On-Screen Display (OSD) menu item.

Remote control

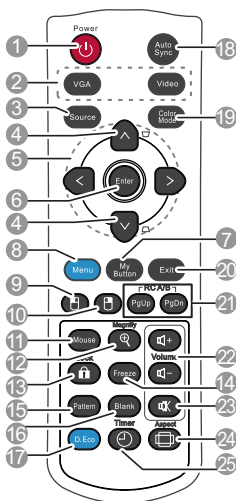



To use the remote mouse control keys (Page Up, Page Down, , and), see "Using the remote mouse control" on page 10 for details.

1. **POWER**
Toggles the projector between standby mode and on.
2. **Source selection keys (VGA/Video)**
Selects an input source for display.
VGA
Selects **D-Sub / Comp. 1** or **D-Sub / Comp. 2** source for display.
Video
Selects **Video** source for display.
- HDMI is only available on models with HDMI input.**
3. **Source**
Displays the source selection bar.
4. **Keystone keys (/)**
Manually corrects distorted images resulting from an angled projection.
5. **</^/~/>**
Selects the desired menu items and makes adjustments.

6. **Enter**
Enacts the selected On-Screen Display (OSD) menu item.
7. **My Button**
Allows user to define a short cut key on the remote control, and the function item is selected in OSD menu.
8. **Menu**
Turns on the On-Screen Display (OSD) menu.
9.
Performs the same function as the left mouse button when the mouse mode is activated.
10.
Performs the same function as the right mouse button when the mouse mode is activated.
11. **Mouse**
Switches between the normal and mouse modes.
Page Up, Page Down, , : active after pressing **Mouse**. An icon appears on the screen to indicate the activation of the mouse mode.

12. **Magnify**
Displays the zoom bar that magnifies or reduces the projected picture size.
13. **Lock **
Activates or deactivates panel key lock.
14. **Freeze**
Freezes the projected image.
15. **Pattern**
Displays embedded test pattern.
16. **Blank**
Hides the screen picture.
17. **DynamicEco™**
Decreases the power consumption of the lamp by up to 30%.

 **It takes some time to initiate this function. Make sure the projector has been turned on for more than 4 minutes. If the projector is resumed by using the Smart Restart feature, this function can be executed immediately.**
18. **Auto Sync**
Automatically determines the best picture timings for the displayed image.
19. **Color Mode**
Selects an available picture setup mode.
20. **Exit**
Goes back to previous OSD menu, exits and saves menu settings.
21. **PgUp (Page Up)/PgDn (Page Down)**
Operates your display software program (on a connected PC) which responds to page up/down commands (like Microsoft PowerPoint) when the mouse mode is activated.
22. **Volume keys (+, -)**
Magnifies or reduces the volume level.
23. 
Toggles the projector audio between on and off.
24. **Aspect**
Selects the display aspect ratio.
25. **Timer**
Displays the presentation timer settings menu.

Remote control code

The projector can be assigned to two different remote control codes, A or B. When several adjacent projectors are in operation at the same time, switching the remote control codes can prevent interference from other remote controls. Set the remote control code for the projector first before changing that for the remote control.

To switch the code for the projector, select **A** or **B** in the **SYSTEM SETTING: ADVANCED > Remote Control Code** menu.

To switch the code for the remote control, press **PgUp** and **PgDn** buttons on the remote control together for 5 seconds or more. The initial code is set to A.



 **If different codes are set on the projector and remote control, there will be no response from the remote control. When that happens, switch the code for the remote control again.**

Using the remote mouse control

The capability of operating your computer with the remote control gives you more flexibility when delivering presentations.

1. Connect the projector to your PC or notebook with a USB cable prior to using the remote control in place of your computer's mouse. See "[Connecting a computer](#)" on [page 16](#) for details.
2. Set the input signal to **D-Sub / Comp. 1**, **D-Sub / Comp. 2** or **HDMI**.

 **The HDMI input is only available on the PJD5134/PJD5234L/PJD5533w models.**

3. Press **Mouse** on the remote control to switch from the normal mode to the mouse mode. An icon appears on the screen to indicate the activation of the mouse mode.
4. Perform the desired mouse controls on your remote control.
 - To move the cursor on the screen, press $\langle / \wedge / \vee / \rangle$.
 - To left-click, press .
 - To right-click, press .
 - To operate your display software program (on a connected PC) which responds to page up/down commands (like Microsoft PowerPoint), press **PgUp/PgDn**.
 - To return to the normal mode, press **Mouse** again or other keys except for the mouse related multi-function keys.

Remote control effective range

The Infra-Red (IR) remote control is located on the front of the projector. The remote control must be held at an angle within 30 degrees perpendicular to the projector's IR remote control sensor to function correctly. The distance between the remote control and the sensor should not exceed 8 meters (~ 26 feet).

Make sure that there are no obstacles between the remote control and the IR sensor on the projector that might obstruct the infra-red beam.

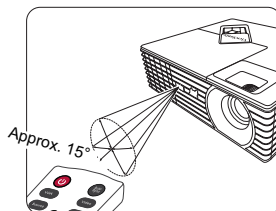

Replacing the remote control batteries

1. To open the battery cover, turn the remote control over to view its back, push on the finger grip on the cover and slide it in the direction of the arrow as illustrated. The cover will slide off.
2. Remove any existing batteries (if necessary) and install two AAA batteries observing the battery polarities as indicated in the base of the battery compartment. Positive (+) goes to positive and negative (-) goes to negative.
3. Refit the cover by aligning it with the base and sliding it back down into position. Stop when it clicks into place.

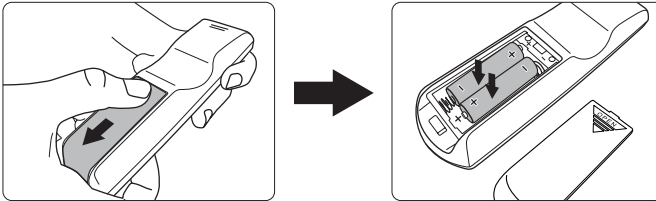

- **Avoid leaving the remote control and batteries in an excessive heat or humid environment like the kitchen, bathroom, sauna, sunroom or in a closed car.**
- **Replace only with the same or equivalent type recommended by the battery manufacturer.**
- **Dispose of the used batteries according to the manufacturer's instructions and local environment regulations for your region.**
- **Never throw the batteries into a fire. There may be danger of an explosion.**
- **If the batteries are dead or if you will not be using the remote control for an extended period of time, remove the batteries to avoid damage to the remote control from possible battery leakage.**

Positioning your projector

Choosing a location

Your room layout or personal preference will dictate which installation location you select. Take into consideration the size and position of your screen, the location of a suitable power outlet, as well as the location and distance between the projector and the rest of your equipment.

Your projector is designed to be installed in one of four possible installation locations:

1. Front Table

Select this location with the projector placed near the floor in front of the screen. This is the most common way to position the projector for quick setup and portability.

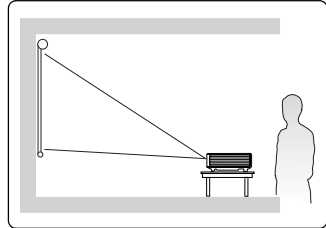

2. Front Ceiling

Select this location with the projector suspended upside-down from the ceiling in front of the screen.

Purchase the projector ceiling mount kit from your dealer to mount your projector on the ceiling.

Set **Front Ceiling** in the **SYSTEM SETTING: BASIC > Projector Position** menu after you turn the projector on.

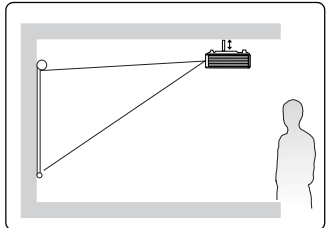

3. Rear Ceiling

Select this location with the projector suspended upside-down from the ceiling behind the screen.

Note that a special rear projection screen and the projector ceiling mounting kit are required for this installation location.

Set **Rear Ceiling** in the **SYSTEM SETTING: BASIC > Projector Position** menu after you turn the projector on.

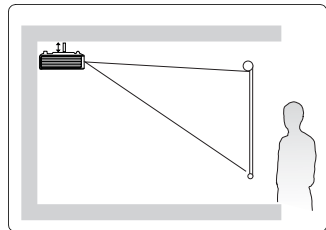

4. Rear Table

Select this location with the projector placed near the floor behind the screen.

Note that a special rear projection screen is required.

Set **Rear Table** in the **SYSTEM SETTING: BASIC > Projector Position** menu after you turn the projector on.

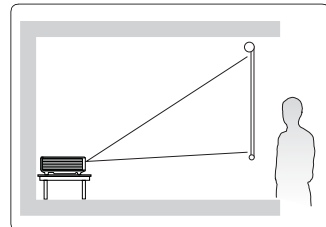

Projection dimensions

Refer to "[Dimensions](#)" on page 60 for the center of lens dimensions of this projector before calculating the appropriate position.

 The "screen" mentioned below refers to the projection screen usually consisting of a surface and a support structure

PJD5132/PJD5232L/PJD5134/PJD5234L

- 4:3 image on a 4:3 screen

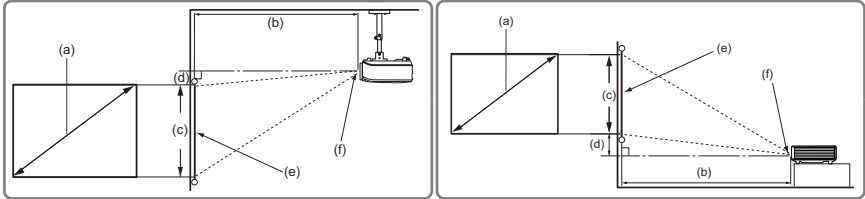

- 16:9 image on a 4:3 screen

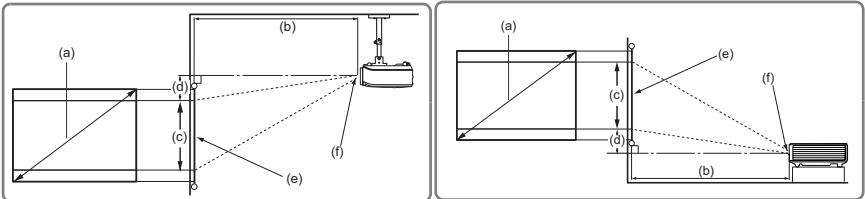

(e): Screen (f): Center of lens

(a) Screen Size [inch (m)]	4:3 image on a 4:3 Screen				16:9 image on a 4:3 Screen			
	(b) Projection distance [m (inch)]		(c) Image height [cm (inch)]	(d) Vertical offset [cm (inch)]	(b) Projection distance [m (inch)]		(c) Image height [cm (inch)]	(d) Vertical offset [cm (inch)]
	min.	max.	min.		max.			
30 (0.8)	1.1 (45)	1.2 (49)	46 (18)	5 (1.8)	1.1 (45)	1.2 (49)	34 (14)	10.3 (4.1)
40 (1.0)	1.5 (59)	1.7 (65)	61 (24)	6 (2.4)	1.5 (59)	1.7 (65)	46 (18)	13.7 (5.4)
50 (1.3)	1.9 (74)	2.1 (82)	76 (30)	8 (3.0)	1.9 (74)	2.1 (82)	57 (23)	17.1 (6.8)
60 (1.5)	2.3 (89)	2.5 (98)	91 (36)	9 (3.6)	2.3 (89)	2.5 (98)	69 (27)	20.6 (8.1)
70 (1.8)	2.6 (104)	2.9 (114)	107 (42)	11 (4.2)	2.6 (104)	2.9 (114)	80 (32)	24.0 (9.5)
80 (2.0)	3.0 (119)	3.3 (131)	122 (48)	12 (4.8)	3.0 (119)	3.3 (131)	91 (36)	27.4 (10.8)
90 (2.3)	3.4 (134)	3.7 (147)	137 (54)	14 (5.4)	3.4 (134)	3.7 (147)	103 (41)	30.9 (12.2)
100 (2.5)	3.8 (149)	4.2 (163)	152 (60)	15 (6.0)	3.8 (149)	4.2 (163)	114 (45)	34.3 (13.5)
120 (3.0)	4.5 (178)	5.0 (196)	183 (72)	18 (7.2)	4.5 (178)	5.0 (196)	137 (54)	41.1 (16.2)
150 (3.8)	5.7 (223)	6.2 (245)	229 (90)	23 (9.0)	5.7 (223)	6.2 (245)	171 (68)	51.4 (20.3)
200 (5.1)	7.5 (297)	8.3 (327)	305 (120)	30 (12.0)	7.5 (297)	8.3 (327)	229 (90)	68.6 (27.0)
250 (6.4)	9.4 (371)	10.4 (409)	381 (150)	38 (15.0)	9.4 (371)	10.4 (409)	286 (113)	85.7 (33.8)
300 (7.6)	11.3 (446)	12.5 (490)	457 (180)	46 (18.0)	11.3 (446)	12.5 (490)	343 (135)	102.9 (40.5)

PJD5533w

- 16:10 image on a 16:10 screen

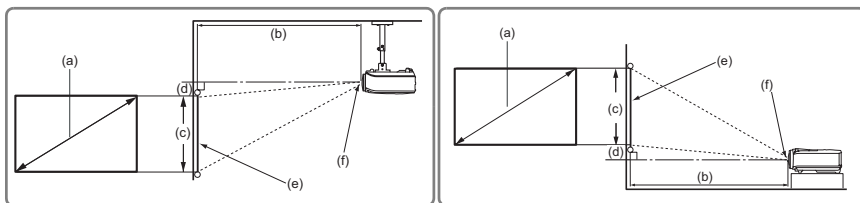

- 16:10 image on a 4:3 screen

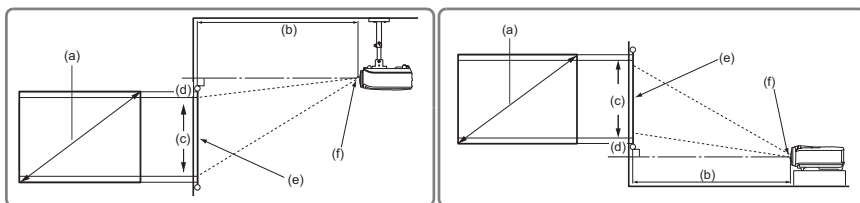

(e): Screen (f): Center of lens

(a) Screen Size [inch (m)]	16:10 image on a 16:10 Screen				16:10 image on a 4:3 Screen			
	(b) Projection distance [m (inch)]		(c) Image height [cm (inch)]	(d) Vertical offset [cm (inch)]	(b) Projection distance [m (inch)]		(c) Image height [cm (inch)]	(d) Vertical offset [cm (inch)]
	min.	max.			min.	max.		
30 (0.8)	0.97 (38)	1.06 (42)	40 (16)	0 (0.0)	0.91 (36)	1.00 (40)	38 (15)	3.8 (1.5)
40 (1.0)	1.29 (51)	1.42 (56)	54 (21)	0 (0.0)	1.22 (48)	1.34 (53)	51 (20)	5.1 (2.0)
50 (1.3)	1.61 (64)	1.77 (70)	67 (26)	0 (0.0)	1.52 (60)	1.67 (66)	64 (25)	6.4 (2.5)
60 (1.5)	1.94 (76)	2.13 (84)	81 (32)	0 (0.0)	1.83 (72)	2.01 (79)	76 (30)	7.6 (3.0)
70 (1.8)	2.26 (89)	2.48 (98)	94 (37)	0 (0.0)	2.13 (84)	2.34 (92)	89 (35)	8.9 (3.5)
80 (2.0)	2.58 (102)	2.84 (112)	108 (42)	0 (0.0)	2.43 (96)	2.68 (105)	102 (40)	10.2 (4.0)
90 (2.3)	2.90 (114)	3.19 (126)	121 (48)	0 (0.0)	2.74 (108)	3.01 (119)	114 (45)	11.4 (4.5)
100 (2.5)	3.23 (127)	3.55 (140)	135 (53)	0 (0.0)	3.04 (120)	3.35 (132)	127 (50)	12.7 (5.0)
120 (3.0)	3.87 (152)	4.26 (168)	162 (64)	0 (0.0)	3.65 (144)	4.02 (158)	152 (60)	15.2 (6.0)
150 (3.8)	4.84 (191)	5.32 (210)	202 (79)	0 (0.0)	4.56 (180)	5.02 (198)	191 (75)	19.1 (7.5)
200 (5.1)	6.45 (254)	7.10 (279)	269 (106)	0 (0.0)	6.09 (240)	6.70 (264)	254 (100)	25.4 (10.0)
250 (6.4)	8.06 (318)	8.87 (349)	337 (132)	0 (0.0)	7.61 (300)	8.37 (329)	318 (125)	31.8 (12.5)
300 (7.6)	9.68 (381)	10.65 (419)	404 (159)	0 (0.0)	9.13 (359)	10.04 (395)	381 (150)	38.1 (15.0)

 There is 3% tolerance among these numbers due to optical component variations. It is recommended that if you intend to permanently install the projector, you should physically test the projection size and distance using the actual projector in situ before you permanently install it, so as to make allowance for this projector's optical characteristics. This will help you determine the exact mounting position so that it best suits your installation location.

Connection

When connecting a signal source to the projector, be sure to:

1. Turn all equipment off before making any connections.
2. Use the correct signal cables for each source.
3. Ensure the cables are firmly inserted.

- In the connections shown below, some cables may not be included with the projector (see "Shipping contents" on page 5). They are commercially available from electronics stores.
- The connection illustrations below are for reference only. The rear connecting jacks available on the projector vary with each projector model.
- For detailed connection methods, see pages 16-19.

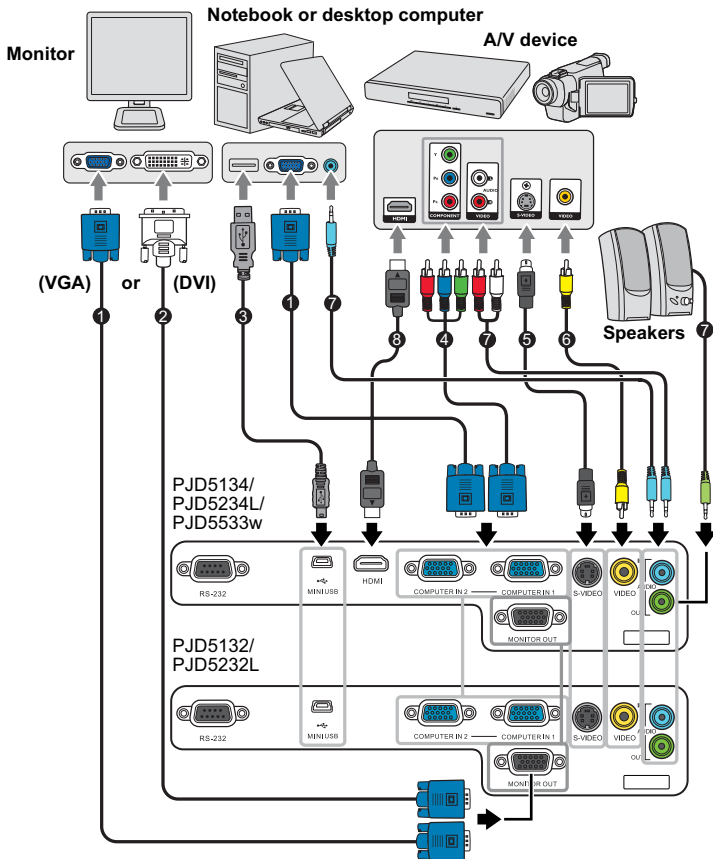

1. VGA cable	5. S-Video cable
2. VGA to DVI-A cable	6. Video cable
3. USB cable	7. Audio cable
4. Component Video to VGA (D-Sub) adapter cable	8. HDMI cable

Connecting a computer or monitor

Connecting a computer

The projector provides two VGA input sockets that allow you to connect them to both IBM® compatibles and Macintosh® computers. A Mac adapter is needed if you are connecting legacy version Macintosh computers.

To connect the projector to a notebook or desktop computer:

1. Take the supplied VGA cable and connect one end to the D-Sub output socket of the computer.
2. Connect the other end of the VGA cable to the **COMPUTER IN 1** or **COMPUTER IN 2** signal input socket on the projector.
3. If you wish to use the remote paging function, take a USB cable and connect the larger end to the USB port of the computer, and smaller end to the **MINI USB** socket on the projector. See "[Using the remote mouse control](#)" on page 10 for details.

 **Many notebooks do not turn on their external video ports when connected to a projector. Usually a key combo like FN + F3 or CRT/LCD key turns the external display on/off. Locate a function key labeled CRT/LCD or a function key with a monitor symbol on the notebook. Press FN and the labeled function key simultaneously. Refer to your notebook's documentation to find your notebook's key combination.**

Connecting a monitor

If you want to view your presentation close-up on a monitor as well as on the screen, you can connect the **MONITOR OUT** signal output socket on the projector to an external monitor with a VGA cable following the instructions below:

To connect the projector to a monitor:

1. Connect the projector to a computer as described in "[Connecting a computer](#)" on page 16.
2. Take a suitable VGA cable (only one supplied) and connect one end of the cable to the D-Sub input socket of the video monitor.
Or if your monitor is equipped with a DVI input socket, take a VGA to DVI-A cable and connect the DVI end of the cable to the DVI input socket of the video monitor.
3. Connect the other end of the cable to the **MONITOR OUT** socket on the projector.

 • **The MONITOR OUT output only works when COMPUTER IN 1 connection is made to the projector.**

- **To use this connection method when the projector is in standby mode, turn on the Active VGA Out function under the SYSTEM SETTING: BASIC > Standby Settings menu.**

Connecting Video source devices

You can connect your projector to various Video source devices that provide any one of the following output sockets:

- HDMI
- Component Video
- S-Video
- Video (composite)

You need only connect the projector to a Video source device using just one of the above connecting methods, however each provides a different level of video quality. The method you choose will most likely depend upon the availability of matching terminals on both the projector and the Video source device as described below:

Best video quality

The best available video connection method is HDMI. If your source device is equipped with a HDMI socket, you can enjoy uncompressed digital video quality.

See "[Connecting an HDMI device](#)" on page 18 for how to connect the projector to a HDMI source device and other details.

 **The HDMI input is only available on the PJD5134/PJD5234L/PJD5533w models.**

If no **HDMI** source is available, the next best video signal is Component video (not to be confused with composite video). Digital TV tuner and DVD players output Component video natively, so if available on your devices, this should be your connection method of choice in preference to (composite) video.

See "[Connecting a Component Video source device](#)" on page 18 for how to connect the projector to a component video device.

Better video quality

The S-Video method provides a better quality analog video than standard composite Video. If you have both composite Video and S-Video output terminals on your Video source device, you should elect to use the S-Video option.

See "[Connecting an S-Video source device](#)" on page 19 for how to connect the projector to an S-Video device.

Least video quality

Composite Video is an analog video and will result in a perfectly acceptable, but less than optimal result from your projector, being the least video quality of the available methods described here.

See "[Connecting a composite Video source device](#)" on page 19 for how to connect the projector to a composite Video device.

Connecting audio

The projector has one built-in mono speaker which is designed to provide basic audio functionality accompanying data presentations for business purposes only. It is not designed for, nor intended for stereo audio reproduction use as might be expected in home theater or home cinema applications. Any stereo audio input (if provided), is mixed into a common mono audio output through the projector speaker.

If you wish, you can make use of the projector (mixed mono) speaker in your presentations, and also connect separate amplified speakers to the Audio Out socket of the projector. The audio output is a mixed mono signal and controlled by the projector Volume and Mute settings.

If you have a separate sound system, you will most likely want to connect the audio output of your Video source device to that sound system, instead of to the mono audio projector.

Connecting an HDMI device

You should use an HDMI cable when making connection between the projector and HDMI devices.

To connect the projector to an HDMI device:

1. Take an HDMI cable and connect one end to the HDMI output port of the video device.
2. Connect the other end of the cable to the **HDMI** input port on the projector.

-  • **In the unlikely event that you connect the projector to a DVD player via the projector's HDMI input and the projected picture displays wrong colors, please change the color space to YUV. See "Changing HDMI input settings" on page 25 for details.**
- **The projector is only capable of playing mixed mono audio, even if a stereo audio input is connected. See "Connecting audio" on page 17 for details.**
- **The HDMI input is only available on the PJD5134/PJD5234L/PJD5533w models.**



Connecting a Component Video source device

Examine your Video source device to determine if it has a set of unused Component Video output sockets available:

- If so, you can continue with this procedure.
- If not, you will need to reassess which method you can use to connect to the device.

To connect the projector to a Component Video source device:

1. Take a VGA (D-Sub)-Component adaptor cable and connect the end with 3 RCA type connectors to the Component Video output sockets of the Video source device. Match the color of the plugs to the color of the sockets; green to green, blue to blue, and red to red.
2. Connect the other end of the VGA (D-Sub)-Component adaptor cable (with a D-Sub type connector) to the **COMPUTER IN 1** or **COMPUTER IN 2** socket on the projector.

-  • **The projector is only capable of playing mixed mono audio, even if a stereo audio input is connected. See "Connecting audio" on page 17 for details.**
- **If the selected video image is not displayed after the projector is turned on and the correct video source has been selected, check that the Video source device is turned on and operating correctly. Also check that the signal cables have been connected correctly.**
-  **VGA-Component adaptor
(ViewSonic P/N: CB-00008906)**

Connecting an S-Video source device

Examine your Video source device to determine if it has an unused S-Video output socket available:

- If so, you can continue with this procedure.
- If not, you will need to reassess which method you can use to connect to the device.

To connect the projector to an S-Video source device:

1. Take an S-Video cable and connect one end to the S-Video output socket of the Video source device.
2. Connect the other end of the S-Video cable to the **S-VIDEO** socket on the projector.



- **The projector is only capable of playing mixed mono audio, even if a stereo audio input is connected. See "Connecting audio" on page 17 for details.**
- **If the selected video image is not displayed after the projector is turned on and the correct video source has been selected, check that the Video source device is turned on and operating correctly. Also check that the signal cables have been connected correctly.**
- **If you have already made a Component Video connection between the projector and this S-Video source device using Component Video connections, you need not connect to this device using an S-Video connection as this makes an unnecessary second connection of poorer picture quality. See "Connecting Video source devices" on page 17 for details.**

Connecting a composite Video source device

Examine your Video source device to determine if it has a set of unused composite Video output sockets available:

- If so, you can continue with this procedure.
- If not, you will need to reassess which method you can use to connect to the device.

To connect the projector to a composite Video source device:

1. Take a Video cable and connect one end to the composite Video output socket of the Video source device.
2. Connect the other end of the Video cable to the **VIDEO** socket on the projector.



- **The projector is only capable of playing mixed mono audio, even if a stereo audio input is connected. See "Connecting audio" on page 17 for details.**
- **If the selected video image is not displayed after the projector is turned on and the correct video source has been selected, check that the Video source device is turned on and operating correctly. Also check that the signal cables have been connected correctly.**
- **You need only connect to this device using a composite Video connection if Component Video and S-Video inputs are unavailable for use. See "Connecting Video source devices" on page 17 for details.**

Operation

Starting up the projector

1. Plug the power cord into the projector and into a wall socket. Turn on the wall socket switch (where fitted).
2. Press **POWER** on the projector or remote control to start the projector. The **POWER indicator light** stays blue when the projector is on.
(If necessary) Rotate the focus ring to adjust the image clearness.

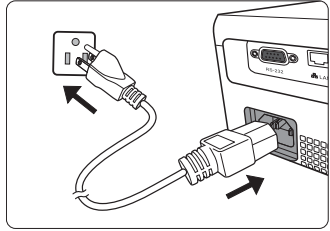

- ☞ • **If the projector is still hot from previous activity, it will run the cooling fan for approximately 60 seconds before energizing the lamp.**
 - **To maintain the lamp life, once you turn the projector on, wait at least 5 minutes before turning it off.**
3. If the projector is activated for the first time, select your OSD language following the on-screen instructions.
 4. Switch all of the connected equipment on.
 5. The projector will start to search for input signals. The current input signal being scanned appears in the upper left corner of the screen. If the projector doesn't detect a valid signal, the message '**No Signal**' will continue to be displayed until an input signal is found.
You can also press **SOURCE** on the projector or remote control to select your desired input signal. See "[Switching input signal](#)" on page 25 for details.
- ☞ • **If the frequency/resolution of the input signal exceeds the projector's operating range, you will see the message 'Out of Range' displayed on a blank screen. Please change to an input signal which is compatible with the projector's resolution or set the input signal to a lower setting. See "[Timing chart](#)" on page 61 for details.**

Using the menus

The projector is equipped with On-Screen Display (OSD) menus for making various adjustments and settings.

 The OSD screenshots below are for reference only, and may differ from the actual design.

Below is the overview of the OSD menu.

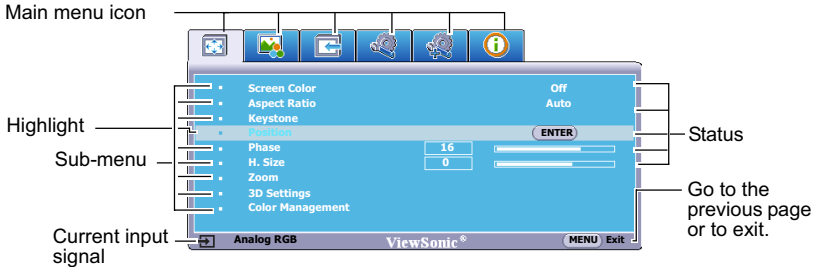

To use the OSD menus, please set them to your familiar language first.



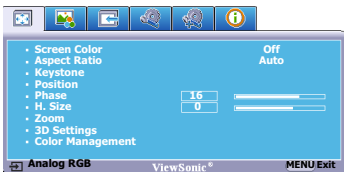



1. Press **MENU/EXIT** on the projector or **Menu** on the remote control to turn the OSD menu on.
3. Press \checkmark to highlight **Language** and press \langle / \rangle to select a preferred language.



2. Use \langle / \rangle to highlight the **SYSTEM SETTING: BASIC** menu.
4. Press **MENU/EXIT** twice* on the projector or **Exit** on the remote control to leave and save the settings.



*The first press leads you back to the main menu and the second press closes the OSD menu.

	: DISPLAY		: SYSTEM SETTING: BASIC
	: PICTURE		: SYSTEM SETTING: ADVANCED
	: SOURCE		: INFORMATION

Utilizing the password function

For security purposes and to help prevent unauthorized use, the projector includes an option for setting up password security. The password can be set through the On-Screen Display (OSD) menu. For details of the OSD menu operation, please refer to "Using the menus" on page 21.

 **You will be inconvenienced if you activate the password functionality and subsequently forget the password. Print this user manual (if necessary) and write the password you used in this manual, and keep it in a safe place for later use.**

Setting a password

1. Open the OSD menu and go to the **SYSTEM SETTING: ADVANCED > Security Settings** menu. Press **MODE/ENTER** on the projector or **Enter** on the remote control. The **Security Settings** page is displayed.
2. Highlight **Power On Lock** and select **On** by pressing **</>**.
3. As pictured to the right, the four arrow keys (**<**, **^**, **v**, **>**) respectively represent 4 digits (1, 2, 3, 4). According to the password you desire to set, press the arrow keys to enter six digits for the password.
4. Confirm the new password by re-entering the new password.
Once the password is set, the OSD menu returns to the **Security Settings** page.
5. To leave the OSD menu, press **MENU/EXIT** on the projector or **Exit** on the remote control.

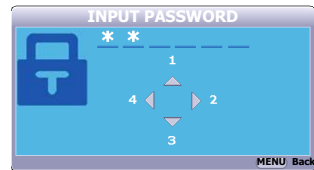

-  • **Once a password has been set, the projector cannot be used unless the correct password is entered every time the projector is started.**
- **The digits being input will be displayed as asterisks on-screen. Write your selected password down here in this user manual in advance or right after the password is entered so that it is available to you should you ever forget it.**
- Password:** _____
- Keep this user manual in a safe place.**

If you forget the password

If the password function is activated, you will be asked to enter the six-digit password every time you turn on the projector. If you enter the wrong password, the password error message as pictured to the right is displayed lasting for three seconds, and the message 'INPUT PASSWORD' follows. You can retry by entering another six-digit password, or if you did not record the password in this user manual, and you absolutely do not remember it, you can use the password recall procedure. See "Entering the password recall procedure" on page 23 for details.

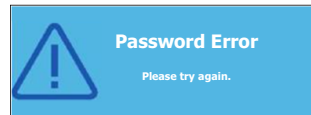

If you enter an incorrect password 5 times in succession, the projector will automatically shut down in a short time.

Entering the password recall procedure

1. Press and hold **AUTO** on the projector or **Auto Sync** on the remote control for 3 seconds. The projector will display a coded number on the screen.
2. Write down the number and turn off your projector.
3. Seek help from the local service center to decode the number. You may be required to provide proof of purchase documentation to verify that you are an authorized user of the projector.

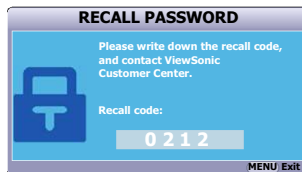

Changing the password

1. Open the OSD menu and go to the **SYSTEM SETTING: ADVANCED > Security Settings > Change Password** menu.
2. Press **MODE/ENTER** on the projector or **Enter** on the remote control. The message '**INPUT CURRENT PASSWORD**' is displayed.
3. Enter the old password.
 - If the password is correct, another message '**INPUT NEW PASSWORD**' is displayed.
 - If the password is incorrect, the password error message is displayed lasting for three seconds, and the message '**INPUT CURRENT PASSWORD**' is displayed for your retry. You can press **MENU/EXIT** on the projector or **Exit** on the remote control to cancel the change or try another password.
4. Enter a new password.
5. Confirm the new password by re-entering the new password.
6. You have successfully assigned a new password to the projector. Remember to enter the new password next time the projector is started.
7. To leave the OSD menu, press **MENU/EXIT** on the projector or **Exit** on the remote control.

 The digits being input will be displayed as asterisks on-screen. Write your selected password down here in this user manual in advance or right after the password is entered so that it is available to you should you ever forget it.

Password: _____

Keep this user manual in a safe place.

Disabling the password function

To disable password protection, go back to the **SYSTEM SETTING: ADVANCED > Security Settings > Power On Lock** menu after opening the OSD menu system. Select **Off** by pressing **</>**. The message **'INPUT PASSWORD'** is displayed. Enter the current password.

- If the password is correct, the OSD menu returns to the **Security Settings** page with **'Off'** shown in the row of **Power On Lock**. You will not have to enter the password next time you turn on the projector.
- If the password is incorrect, the password error message is displayed lasting for three seconds, and the message **'INPUT PASSWORD'** is displayed for your retry. You can press **MENU/EXIT** on the projector or **Exit** on the remote control to cancel the change or try another password.

 **Though the password function is disabled, you need to keep the old password in hand should you ever need to re-activate the password function by entering the old password.**

Switching input signal

The projector can be connected to multiple devices at the same time. However, it can only display one full screen at a time.

Be sure the **Quick Auto Search** function in the **SOURCE** menu is **On** if you want the projector to automatically search for the signals.

You can also manually select the desired signal by pressing one of the source selection keys on the remote control, or cycle through the available input signals.

1. Press **SOURCE** on the projector or remote control. A source selection bar is displayed.
2. Press **^** / **∨** until your desired signal is selected and press **MODE/ENTER** on the projector or **Enter** on the remote control. Once detected, the selected source information will be displayed on the screen for seconds. If there are multiple devices connected to the projector, repeat steps 1-2 to search for another signal.

- The brightness level of the projected image will change accordingly when you switch between different input signals. Data (graphic) "PC" presentations using mostly static images are generally brighter than "Video" using mostly moving images (movies).
- The input signal type effects the options available for the Color Mode. See **"Selecting a picture mode"** on page 31 for details.
- Please see **"Projector specifications"** on page 58 for the native display resolution of this projector. For best display picture results, you should select and use an input signal which outputs at this resolution. Any other resolutions will be scaled by the projector depending upon the 'aspect ratio' setting, which may cause some image distortion or loss of picture clarity. See **"Selecting the aspect ratio"** on page 28 for details.

Changing HDMI input settings

This function is only available for the PJD5134/PJD5234L/PJD5533w series.

In the unlikely event that you connect the projector to a device (like a DVD or Blu-ray player) via the projector's **HDMI** input and the projected picture displays wrong colors, please change the color space to an appropriate one that fits the color space setting of the output device.

To do this:

1. Open the OSD menu and go to the **SOURCE** menu.
2. Press **∨** to highlight **HDMI Format** and press **</>** to select a suitable color space according to the color space setting of the output device connected.
 - **RGB**: Sets the color space as RGB.

PJD5132/PJD5232L

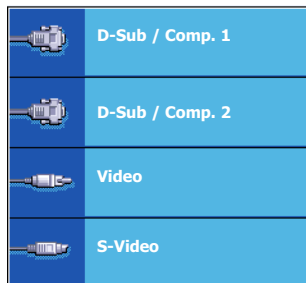

PJD5134/PJD5234L/PJD5533w

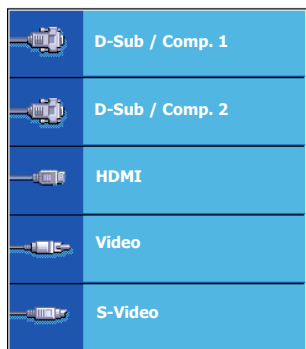

- **YUV**: Sets the color space as YUV.
 - **Auto**: Sets the projector to detect the color space setting of input signal automatically.
3. Press \checkmark to highlight **HDMI Range** and press \langle / \rangle to select a suitable HDMI color range according to the color range setting of the output device connected.
 - **Enhanced**: Sets the HDMI color range as 0 - 255.
 - **Normal**: Sets the HDMI color range as 15 - 235.

- ☞ • This function is only available when the HDMI input port is in use.
- Refer to the documentation of the device for information on the color space setting.

Adjusting the projected image

Adjusting the projection angle

The projector is equipped with an adjuster foot. It changes the image height and vertical projection angle. Screw the adjuster foot to fine tune the angle until the image is positioned where you want it.

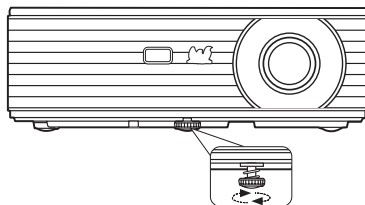

If the projector is not placed on a flat surface or the screen and the projector are not perpendicular to each other, the projected image becomes trapezoidal. To correct this situation, see "[Correcting keystone](#)" on page 27 for details.

⚠ **Do not look into the lens while the lamp is on. The strong light from the lamp may cause damage to your eyes.**

Auto-adjusting the image

In some cases, you may need to optimize the picture quality. To do this, press **AUTO** on the projector or **Auto Sync** on the remote control. Within 3 seconds, the built-in Intelligent Auto Adjustment function will re-adjust the values of Frequency and Clock to provide the best picture quality.

The current source information will be displayed in the upper left corner of the screen for 3 seconds.

- ☞ • The screen will be blank while **AUTO** is functioning.
- This function is only available when **PC signal (analog RGB)** is selected.

Fine-tuning the image clarity

1. Adjust the projected image to the size that you need using the zoom ring.
2. If necessary, sharpen the image by rotating the focus ring.

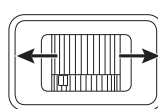
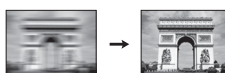
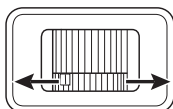

Correcting keystone

Keystoning refers to the situation where the projected image is noticeably wider at either the top or bottom. It occurs when the projector is not perpendicular to the screen.

To correct this, besides adjusting the height of the projector, you will need to manually correct it following one of these steps.

- Using the remote control

Press **▼/▲** on the projector or remote control to display the Keystone correction page. Press **▼** to correct keystoning at the top of the image. Press **▲** to correct keystoning at the bottom of the image.



- Using the OSD menu

1. Press **MENU/EXIT** on the projector or **Menu** on the remote control and then press **</>** until the **DISPLAY** menu is highlighted.
2. Press **▼** to highlight **Keystone** and press **MODE/ENTER** on the projector or **Enter** on the remote control. The **Keystone** correction page is displayed.
3. Press **▲** to correct keystoning at the top of the image or press **▼** to correct keystoning at the bottom of the image.

Magnifying and searching for details

If you need to find the details on the projected picture, magnify the picture. Use the direction arrow keys for navigating the picture.

- Using the remote control

1. Press **Magnify** on the remote control to display the Zoom bar.
2. Press **▲** repeatedly to magnify the picture to a desired size.
3. To navigate the picture, press **MODE/ENTER** on the projector or **Enter** on the remote control to switch to the panning mode and press the directional arrows (**<**, **▲**, **▼**, **>**) to navigate the picture.
4. To reduce size of the picture, press **MODE/ENTER** on the projector or **Enter** on the remote control to switch back to the zoom in/out functionality, and press **AUTO/Auto Sync** to restore the picture to its original size. You can also press **▼** repeatedly until it is restored to the original size.

- Using the OSD menu

1. Press **MENU/EXIT** on the projector or **Menu** on the remote control and then press **</>** until the **DISPLAY** menu is highlighted.
2. Press **▼** to highlight **Zoom** and press **MODE/ENTER** on the projector or **Enter** on the remote control. The Zoom bar is displayed.
3. Repeat steps 2-4 in the section of Using the remote control above.

 **The picture can only be navigated after the picture is magnified. You can further magnify the picture while searching for details.**

Selecting the aspect ratio

The 'aspect ratio' is the ratio of the image width to the image height. Most analog TV and computers are in 4:3 ratio, and digital TV and DVDs are usually in 16:9 ratio.

With the advent of digital signal processing, digital display devices like this projector can dynamically stretch and scale the image output to a different aspect than that of the image input signal.

To change the projected image ratio (no matter what aspect the source is):

- Using the remote control
 1. Press **Aspect** to show the current setting.
 2. Press **Aspect** repeatedly to select an aspect ratio to suit the format of the video signal and your display requirements.
- Using the OSD menu
 1. Press **MENU/EXIT** on the projector or **Menu** on the remote control and then press **</>** until the **DISPLAY** menu is highlighted.
 2. Press **✓** to highlight **Aspect Ratio**.
 3. Press **</>** to select an aspect ratio to suit the format of the video signal and your display requirements.

About the aspect ratio

 In the pictures below, the black portions are inactive areas and the white portions are active areas. OSD menus can be displayed on those unused black areas.

1. **Auto:** Scales an image proportionally to fit the projector's native resolution in its horizontal width. This is suitable for the incoming image which is neither in 4:3 nor 16:9 and you want to make most use of the screen without altering the image's aspect ratio.

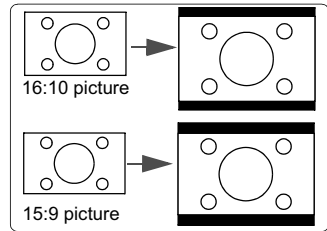

2. **4:3:** Scales an image so that it is displayed in the center of the screen with a 4:3 aspect ratio. This is most suitable for 4:3 images like computer monitors, standard definition TV and 4:3 aspect DVD movies, as it displays them without aspect alteration.

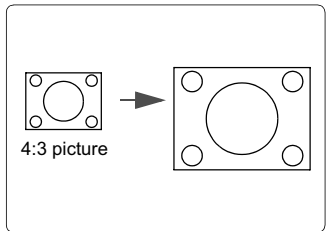

3. **16:9:** Scales an image so that it is displayed in the center of the screen with a 16:9 aspect ratio. This is most suitable for images which are already in a 16:9 aspect, like high definition TV, as it displays them without aspect alteration.

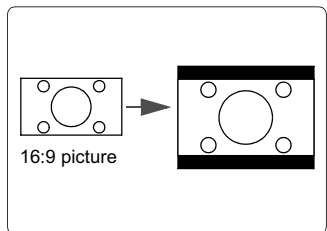

4. **16:10 (PJD5533w only):** Scales an image so that it is displayed in the center of the screen with a 16:10 aspect ratio. This is most suitable for images which are already in a 16:10 aspect, as it displays them without aspect alteration.

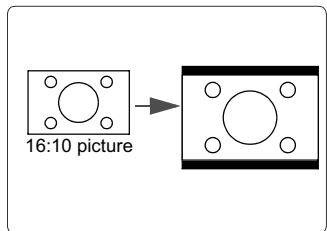

5. **Wide (PJD5533w only):** Scales a 4:3 aspect image vertically and horizontally in a non-linear manner so that it fills the screen with a 16:9 aspect ratio.

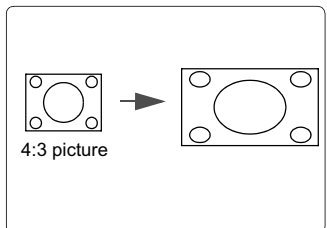

6. **Anamorphic (PJD5132/PJD5134/PJD5232L/
PJD5234L only)**: Scales a 16:9 aspect image
vertically and horizontally in a non-linear
manner so that it fills the screen with a 4:3
aspect ratio.

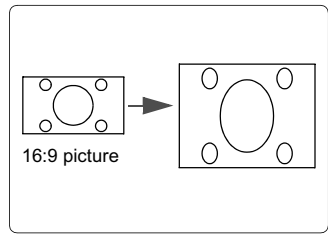

Optimizing the image

Selecting a picture mode

The projector is preset with several predefined picture modes so that you can choose one to suit your operating environment and input signal picture type.

To select an operation mode that suits your need, you can follow one of the following steps.

- Press **MODE/ENTER** on the projector or **Color Mode** on the remote control repeatedly until your desired mode is selected.
- Go to the **PICTURE > Color Mode** menu and press **</>** to select a desired mode.

Picture modes for different types of signals

The picture modes available for different types of signals are listed below.

PC input signals: D-Sub / Comp. 1/2 (analog RGB)

1. **Brightest mode:** Maximizes the brightness of the projected image. This mode is suitable for environments where extra-high brightness is required, such as using the projector in well lit rooms.
2. **PC mode:** Is designed for presentations under daylight environment to match PC and notebook coloring.
3. **ViewMatch mode:** Switches between high brightness performance and accurate color performance.
4. **Movie mode:** Is appropriate for playing colorful movies, video clips from digital cameras or DVs through the PC input for best viewing in a blackened (little light) environment.
5. **Dynamic PC mode:** Is designed for presentations under daylight environment to match PC and notebook coloring. In addition, the projector will optimize the image quality using the dynamic PC function in accordance with the projected contents.

 **It takes some time to initiate this function. Make sure the projector has been turned on for more than 4 minutes.**

If the projector is resumed by using the Smart Restart feature, this function can be executed immediately.

6. **Dynamic Movie mode:** Is appropriate for playing colorful movies, video clips from digital cameras or DVs through the PC input for best viewing in a blackened (little light) environment. In addition, the projector will optimize the image quality using the dynamic Movie function in accordance with the projected contents.

 **It takes some time to initiate this function. Make sure the projector has been turned on for more than 4 minutes.**

If the projector is resumed by using the Smart Restart feature, this function can be executed immediately.

7. **User 1/User 2 mode:** Recalls the settings customized based on the current available picture modes. See "[Setting the User 1/User 2 mode](#)" on page 32 for details.

Video input signals: S-Video, Video, D-Sub / Comp. 1/2 (YPbPr) / HDMI

1. **Brightest mode:** Optimized for daylight viewing, with living room level ambient brightness.
2. **Gaming mode:** Suitable for all types of entertainment media, including gaming and movies.
3. **ViewMatch mode:** Switches between high brightness performance and accurate color performance.

4. **Movie mode:** Is suitable for enjoying dark movies or DVD movies best viewed in a blackened (little light) home cinema or lounge room environment.
5. **Dynamic Movie mode:** Is suitable for enjoying dark movies or DVD movies best viewed in a blackened (little light) home cinema or lounge room environment. In addition, the projector will optimize the image quality using the dynamic Movie function in accordance with the projected contents.



It takes some time to initiate this function. Make sure the projector has been turned on for more than 4 minutes. If the projector is resumed by using the Smart Restart feature, this function can be executed immediately.

6. **User 1/User 2 mode:** Recalls the settings customized based on the current available picture modes. See "[Setting the User 1/User 2 mode](#)" on [page 32](#) for details.

Setting the User 1/User 2 mode

There are two user-definable modes if the current available picture modes are not suitable for your need. You can use one of the picture modes (except the **User 1/User 2**) as a starting point and customize the settings.

1. Press **MENU/EXIT** on the projector or **Menu** on the remote control to open the On-Screen Display (OSD) menu.
2. Go to the **PICTURE > Color Mode** menu.
3. Press **</>** to select **User 1** or **User 2**.
4. Press **∨** to highlight **Reference Mode**.



This function is only available when User 1 or User 2 Mode is selected up in the Color Mode sub-menu item.

5. Press **</>** to select a picture mode that is closest to your need.
6. Press **∨** to select a sub-menu item to be changed and adjust the value with **</>**. See [Fine-tuning the image quality in user modes](#) below for details.
7. When all settings have been done, highlight **Save Settings** and press **MODE/ENTER** on the projector or **Enter** on the remote control to store the settings.
8. The confirmation message '**Setting Saved**' is displayed.

Using Screen Color

In the situation where you are projecting onto a colored surface such as a painted wall which may not be white, the **Screen Color** feature can help correct the projected picture's colors to prevent possible color difference between the source and projected pictures.

To use this function, go to the **DISPLAY > Screen Color** menu and press **</>** to select a color which is closest to the color of the projection surface. There are several precalibrated colors to choose from: **Whiteboard**, **Greenboard**, and **Blackboard**.



This function is only available when a PC type input signal is selected.

Fine-tuning the image quality in user modes

According to the detected signal type, there are some user-definable functions available when **User 1** or **User 2** mode is selected. You can make adjustments to these functions based on your needs.

When you are done making adjustments, remember to go to the **PICTURE > Save Settings** menu and press **MODE/ENTER** to save your settings.

Adjusting Brightness

Highlight the **PICTURE** > **Brightness** menu and press </>.

The higher the value, the brighter the image. And the lower the setting, the darker the image. Adjust this control so the black areas of the image appear just as black and that detail in the dark areas is visible.



Adjusting Contrast

Highlight the **PICTURE** > **Contrast** menu and press </>.

The higher the value, the greater the contrast. Use this to set the peak white level after you have previously adjusted the **Brightness** setting to suit your selected input and viewing environment.



Adjusting Color

Highlight the **PICTURE** > **Color** menu and press </>.

Lower setting produces less saturated colors. If the setting is too high, colors on the image will be overpowering, which makes the image unrealistic.

Adjusting Tint

Highlight the **PICTURE** > **Tint** menu and press </>.

The higher the value, the more reddish the picture becomes. The lower the value, the more greenish the picture becomes.

Adjusting Sharpness

Highlight the **PICTURE** > **Sharpness** menu and press </>.

The higher the value, the sharper the picture becomes. The lower the value, the softer the picture becomes.

Adjusting Brilliant Color

Highlight the **PICTURE** > **Brilliant Color** menu and press </>.

This feature utilizes a new color-processing algorithm and system level enhancements to enable higher brightness while providing truer, more vibrant colors in the projected picture. It enables a greater than 50% brightness increase in mid-tone images, which are common in video and natural scenes, so the projector reproduces images in realistic and true colors. If you prefer images with that quality, select **On**. If you don't need it, select **Off**.

When **Off** is selected, the **Color Temperature** function is not available.

Selecting a Color Temperature

Highlight the **PICTURE** > **Color Temperature** menu and press </>.

The options available for color temperature* settings vary according to the signal type selected.

1. **T1:** With the highest color temperature, T1 makes the image appear the most bluish white than other settings.
2. **T2:** Makes images appear bluish white.
3. **T3:** Maintains normal colorings for white.

4. **T4:** Makes images appear reddish white.

***About color temperatures:**

There are many different shades that are considered to be "white" for various purposes. One of the common methods of representing white color is known as the "color temperature". A white color with a low color temperature appears to be reddish white. A white color with a high color temperature appears to have more blue in it.

Color Management

Only in permanent installations with controlled lighting levels such as boardrooms, lecture theaters, or home theaters, should color management be considered. Color management provides fine color control adjustment to allow for more accurate color reproduction, should you require it.

If you have purchased a test disc which contains various color test patterns and can be used to test the color presentation on monitors, TVs, projectors, etc., you can project any image from the disc on the screen and enter the **Color Management** menu to make adjustments.

To adjust the settings:

1. Go to the **DISPLAY** menu and highlight **Color Management**.
2. Press **MODE/ENTER** on the projector or **Enter** on the remote control and the **Color Management** page is displayed.
3. Highlight **Primary Color** and press **</>** to select a color from among Red, Yellow, Green, Cyan, Blue, or Magenta.

4. Press **∨** to highlight **Hue** and press **</>** to select its range. Increase in the range will include colors consisted of more proportions of its two adjacent colors.

Please refer to the illustration to the right for how the colors relate to each other.

For example, if you select Red and set its range at 0, only pure red in the projected picture will be selected. Increasing its range will include red close to yellow and red close to magenta.

5. Press **∨** to highlight **Saturation** and adjust its values to your preference by pressing **</>**. Every adjustment made will reflect to the image immediately.

For example, if you select Red and set its value at 0, only the saturation of pure red will be affected.

 **Saturation is the amount of that color in a video picture. Lower settings produce less saturated colors; a setting of "0" removes that color from the image entirely. If the saturation is too high, that color will be overpowering and unrealistic.**

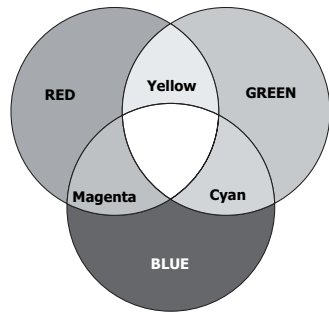

6. Press **∨** to highlight **Gain** and adjust its values to your preference by pressing **</>**. The contrast level of the primary color you select will be affected. Every adjustment made will reflect to the image immediately.
7. Repeat steps 3 to 6 for other color adjustments.
8. Make sure you have made all of the desired adjustments.
9. Press **MENU/EXIT** on the projector or **Exit** on the remote control to exit and save the settings.

Setting the presentation timer

Presentation timer can indicate the presentation time on the screen to help you achieve better time management when giving presentations. Follow these steps to utilize this function:

1. Press **Timer** on the remote control to access the **Presentation Timer** menu or go to the **SYSTEM SETTING: ADVANCED > Presentation Timer** menu and press **MODE/ENTER** to display the **Presentation Timer** page.
2. Highlight **Timer Period** and decide the time period by pressing **</>**. The length of time can be set from 1 to 5 minutes in 1-minute increments and 5 to 240 minutes in 5-minute increments.

 If the timer is already on, the timer will restart whenever the Timer Period is reset.

3. Press **∨** to highlight **Timer Display** and choose if you want the timer to show up on the screen by pressing **</>**.

Selection	Description
Always	Displays the timer on screen throughout the presentation time.
1 min/2 min/3 min	Displays the timer on screen in the last 1/2/3 minute(s).
Never	Hides the timer throughout the presentation time.

4. Press **∨** to highlight **Timer Position** and set the timer position by pressing **</>**.

Top-Left → Bottom-Left → Top-Right → Bottom-Right

5. Press **∨** to highlight **Timer Counting Direction** and select your desired counting direction by pressing **</>**.

Selection	Description
Count Up	Increases from 0 to the preset time.
Count Down	Decreases from the preset time to 0.

6. Press **∨** to highlight **Sound Reminder** and decide if you want to activate sound reminder by pressing **</>**. If you select **On**, a double beep sound will be heard at the last 30 seconds of counting down/up, and a triple beep sound will be produced when the timer is up.
7. To activate the presentation timer, press **∨** and press **</>** to highlight **Start Counting** and press **MODE/ENTER**.
8. A confirmation message displays. Highlight **Yes** and press **MODE/ENTER** on the projector or remote control to confirm. You will see the message **“Timer is On”** displaying on the screen. The timer starts counting when the timer is on.

To cancel the timer, perform the following steps:

1. Go to the **SYSTEM SETTING: ADVANCED > Presentation Timer** menu and highlight **Off**. Press **MODE/ENTER**. A confirmation message displays.
2. Highlight **Yes** and press **MODE/ENTER** to confirm. You will see the message **“Timer is Off”** displaying on the screen.

Hiding the image

In order to draw the audience's full attention to the presenter, you can use  on the projector or **Blank** on the remote control to hide the screen image. Press any key on the projector or remote control to restore the image. The word '**BLANK**' appears at the lower right corner of the screen while the image is hidden.

You can set the blank time in the **SYSTEM SETTING: BASIC > Blank Timer** menu to let the projector return the image automatically after a period of time when there is no action taken on the blank screen.





 Once **Blank** is pressed, the projector enters **Economic mode** automatically.



CAUTION



Do not block the projection lens from projecting as this could cause the blocking object to become heated and deformed or even cause a fire.



Locking control keys

With the control keys on the projector locked, you can prevent your projector settings from being changed accidentally (by children, for example). When the **Panel Key Lock** is on, no control keys on the projector will operate except  **POWER**.

1. Press  on the projector or **Lock**  on the remote control, or go to the **SYSTEM SETTING: BASIC > Panel Key Lock** menu, and select **On** by pressing   on the projector or remote control.
2. A confirmation message is displayed. Select **Yes** to confirm.

To release panel key lock, press and hold  on the projector or **Lock**  on the remote control for 3 seconds.

You can also use the remote control to enter the **SYSTEM SETTING: BASIC > Panel Key Lock** menu and press   to select **Off**.

-  • **Keys on the remote control are still functional when panel key lock is enabled.**
- If you press  **POWER** to turn off the projector without disabling panel key lock, the projector will still be in locked status the next time it is turned on.

Freezing the image

Press **Freeze** on the remote control to freeze the image. The word '**FREEZE**' will be displayed in the upper left corner of the screen. To release the function, press any key on the projector or remote control.

Even if an image is frozen on the screen, the pictures are running on the video or other device. If the connected devices have active audio output, you will still hear the audio even though the image is frozen on screen.

Operating in a high altitude environment

We recommend you use the **High Altitude Mode** when your environment is between 1500 m–3000 m above sea level, and temperature is between 0°C–35°C.

CAUTION

Do not use the **High Altitude Mode** if your altitude is between 0 m and 1500 m and temperature is between 0°C and 35°C. The projector will be over cooled, if you turn the mode on under such a condition.

To activate the **High Altitude Mode**:

1. Press **MENU/EXIT** on the projector or **Menu** on the remote control and then press **</>** until the **SYSTEM SETTING: ADVANCED** menu is highlighted.
2. Press **✓** to highlight **High Altitude Mode** and press **</>** to select **On**. A confirmation message is displayed.
3. Highlight **Yes** and press **MODE/ENTER** on the projector or **Enter** on the remote control.

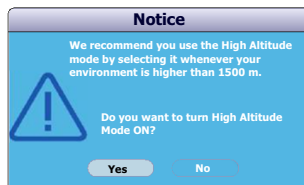

Operation under "**High Altitude Mode**" may cause a higher decibel operating noise level because of increased fan speed necessary to improve overall system cooling and performance.

If you use this projector under other extreme conditions excluding the above, it may display auto shut-down symptoms, which is designed to protect your projector from over-heating. In cases like this, you should switch to **High Altitude Mode** to solve these symptoms. However, this is not to state that this projector can operate under any and all harsh or extreme conditions.

Using the CEC function

This projector supports CEC (Consumer Electronics Control) function for synchronized power on/off operation via HDMI connection. That is, if a device that also supports CEC function is connected to the HDMI input of the projector, when the projector's power is turned on or off, the power of the connected device will also be turned on or off automatically (and vice versa).

To turn on the CEC function:

1. Press **MENU/EXIT** on the projector or **Menu** on the remote control to open the On-Screen Display (OSD) menu.
2. Go to the **SYSTEM SETTING: BASIC > CEC** menu.
3. Press **</>** to select **On**.



- **In order for the CEC function to work properly, make sure that the device is correctly connected to the HDMI input of the projector via a HDMI cable, and its CEC function is turned on.**
- **Depending on the connected device, the CEC function may not work.**

Using the 3D functions

This projector features 3D function which enables you to enjoy 3D movies, videos, and sporting events in a more realistic way by presenting the depth of the images. You need to wear a pair of 3D glasses to view 3D images.

If the 3D signal is input from an HDMI 1.4a compatible device, the projector detects the signal for **3D Sync** information and once detected, it projects images in 3D format automatically. In other cases, you may need to manually select a **3D Sync** format for the projector to project 3D images correctly.

To select a **3D Sync** format:

1. Press **MENU/EXIT** on the projector or **Menu** on the remote control and then press **</>** until the **DISPLAY** menu is highlighted.

2. Press **✓** to highlight **3D Settings** and press **MODE/ENTER** on the projector or **Enter** on the remote control.
3. Press **✓** to highlight **3D Sync** and press **MODE/ENTER** on the projector or **Enter** on the remote control.
4. Press **✓** to select a **3D Sync** setting according to the table below and then press **MODE/ENTER** on the projector or **Enter** on the remote control to confirm.

Input signal type (resolution)	Default setting	3D Sync options available
HDMI (PC) and DVI-D 120Hz signals (SVGA 120Hz, XGA 120Hz, WXGA 120Hz, 1280x720 120Hz)	Frame Sequential	Off, Frame Sequential
HDMI (PC) and DVI-D 60Hz signals (up to 1920x1200 60Hz)	Off	Off, Frame Sequential, Frame Packing, Top-Bottom, Side-by-Side
Video, S-Video signals (HQFs) and Component video, HDMI signals (NTSC 480i)	Off	Off, Frame Sequential
Component video, HDMI signals (480p, 720p, 1080p, 1080i) without 3D information frame	120Hz: Off 60Hz: Off	120Hz: Off, Frame Sequential 60Hz: Off, Frame Sequential, Frame Packing, Top-Bottom, Side-by-Side
HDMI 1.4a signals (720p, 1080i, 1080p) with 3D information frame	Auto	Auto, Off, Frame Sequential, Frame Packing, Top-Bottom, Side-by-Side

For example, if the signal is input from the projector's S-Video input socket, and its signal type (resolution) is 480i, then the default **3D Sync** setting of the projector is **Off**, and the options you can choose for the **3D Sync** setting are **Off** and **Frame Sequential**.

When the 3D Sync function is on:

- The brightness level of the projected image will decrease.
- The Color Mode cannot be adjusted.
- The Keystone can only be adjusted within limited degrees.
- The Zoom can only magnify the pictures to limited sizes.

If you discover the inversion of the 3D image depth, set the 3D Sync Invert function to "Invert" to correct the problem.

Using the projector in standby mode

Some of the projector functions are available in standby mode (plugged in but not turned on). To use these functions, be sure you have turned on the corresponding menus under **SYSTEM SETTING: BASIC > Standby Settings**, and the cable connections are correctly made. For the connection methods, see the Connection chapter.

Power Saving

Less than 0.5W power consumption when **Power Saving** mode is turned on.

Active VGA Out

Selecting **On** outputs a VGA signal when the **COMPUTER IN 1** and **COMPUTER OUT** sockets are correctly connected to devices. The projector outputs the signal received only from **COMPUTER IN 1**.

Active Audio Out

Selecting **On** outputs an audio signal when the **AUDIO IN** and **AUDIO OUT** sockets are correctly connected to devices.

Quick Power Off

Selecting **On** enables the function and the projector will not enter the cooling process after being shut down. Selecting **Off** disables the function and the projector will enter normal cooling process after being shut down.

- ☞ • If you attempt to restart the projector right after it's been turned off, it may not be turned on successfully and will rerun its cooling procedure.
- When **Off** is selected, the Smart Restart function will be automatically turned off.

Shutting down the projector

1. Press **POWER** and a confirmation message is displayed prompting you.
If you don't respond in a few seconds, the message will disappear.
2. Press **POWER** a second time.
3. Disconnect the power cord from the wall socket if the projector will not be used in an extended period of time.

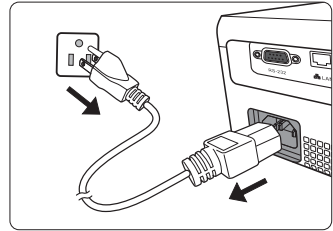

⚠ CAUTION

- To protect the lamp, the projector will not respond to any commands during the cooling process.
- To shorten the cooling time, you can also activate the **Quick Power Off** function. See "**Quick Power Off**" on page 39 for details.
- Do not unplug the power cord before the projector shutdown sequence is complete.

Menu operation

Menu system

Please note that the on-screen display (OSD) menus vary according to the signal type selected.

The menu items are available when the projector detects at least one valid signal. If there is no equipment connected to the projector or no signal detected, limited menu items are accessible.

Main menu	Sub-menu	Options	
1. DISPLAY	Screen Color	Off/Blackboard/Greenboard/Whiteboard	
	Aspect Ratio	Auto/4:3/16:9/ 16:10 (PJD5533w only)/Wide (PJD5533w only)/Anamorphic (PJD5132/PJD5134/PJD5232L/PJD5234L only)	
	Keystone		
	Position		
	Phase		
	H. Size		
	Zoom		
	3D Settings	3D Sync	Auto/Off/Frame Sequential/Frame Packing/Top-Bottom/Side-by-Side
		3D Sync Invert	Disable/Invert
	Color Management	Primary Color	R/G/B/C/M/Y
		Hue	
		Saturation	
		Gain	
2. PICTURE	Color Mode	PC source: Brightest/PC/ViewMatch/Movie/Dynamic PC/Dynamic Movie/User 1/User 2 Video source: Brightest/Gaming/ViewMatch/Movie/Dynamic Movie/User 1/User 2	
	Reference Mode	PC source: Brightest/PC/ViewMatch/Movie/Dynamic PC/Dynamic Movie Video source: Brightest/Gaming/ViewMatch/Movie/Dynamic Movie	
	Brightness		
	Contrast		
	Color		
	Tint		
	Sharpness		
	Brilliant Color	On/Off	
	Color Temperature	T1/T2/T3/T4	
	Save Settings		

Main menu	Sub-menu	Options	
3. SOURCE	Quick Auto Search	Off/On	
	HDMI Format (PJD5134/PJD5234L/ PJD5533w only)	RGB/YUV/Auto	
	HDMI Range (PJD5134/PJD5234L/ PJD5533w only)	Enhanced/Normal	
	DynamicEco Timer	Disable/5 min/10 min/15 min/ 30 min	
	Smart Restart	Off/On	
	Pattern	Off/01/02/03/04/05	
	My Button	Projection (Projector Position)/3D Sync/Lamp Mode/ DCR/Closed Caption/Auto Off (Auto Power Off)/ Message/Screen Color/CEC (PJD5134/PJD5234L/ PJD5533w only)/Auto Search (Quick Auto Search)/ Information	
4. SYSTEM SETTING: BASIC	Language	Multi-language OSD selection	
	Projector Position	Front Table/Rear Table/Rear Ceiling/Front Ceiling	
	Auto Power Off	Disable/5 min/10 min/20 min/ 30 min/40 min/50 min/60 min	
	Timer	Blank Timer	Disable/5 min/10 min/15 min/ 20 min/25 min/30 min
		Sleep Timer	Off/30 min/1 hour/2 hours/3 hours/4 hours/8 hours/12 hours
	Panel Key Lock	On/Off	
	Splash Screen	Black/Blue/ViewSonic/Off	
	Message	On/Off	
	Standby Settings	Power Saving	On/Off
		Active VGA Out	On/Off
		Active Audio Out	On/Off
Quick Power Off		On/Off	
CEC (PJD5134/PJD5234L/PJD5533w only)	On/Off		

**5.
SYSTEM
SETTING:
ADVANCED**



High Altitude Mode		On/Off
DCR		On/Off
Audio Settings	Mute	On/Off
	Volume	
Menu Settings	Menu Display Time	5 sec/10 sec/15 sec/20 sec/25 sec/30 sec
	Menu Position	Center/Top-Left/Top-Right/Bottom-Left/Bottom-Right
Closed Caption	Closed Caption Enable	On/Off
	Caption Version	CC1/CC2/CC3/CC4
Lamp Settings	Lamp Mode	Normal/Economic
	Reset Lamp Timer	
	Equivalent Lamp Hour	
Presentation Timer	Timer Period	1~240 minutes
	Timer Display	Always/1 min/2 min/3 min/ Never
	Timer Position	Top-Left/Bottom-Left/Top-Right/Bottom-Right
	Timer Counting Direction	Count Down/Count Up
	Sound Reminder	On/Off
	Start Counting/Off	
Security Settings	Change Password	
	Power On Lock	On/Off
Remote Control Code		A/B
Reset Settings	Reset All Settings	
	Reset Color Settings	

Main menu	Sub-menu	Options
6. INFORMATION	Current System Status	<ul style="list-style-type: none">• Source• Color Mode• Resolution• Color System• Equivalent Lamp Hour

Description of each menu



Function	Description
1. DISPLAY menu	Screen Color Corrects the projected picture's color when the projection surface is not white. See " Using Screen Color " on page 32 for details.
	Aspect Ratio There are three options to set the image's aspect ratio depending on your input signal source. See " Selecting the aspect ratio " on page 28 for details.
	Keystone Corrects any keystone of the image. See " Correcting keystone " on page 27 for details.
	Position Displays the position adjustment page. To move the projected image, use the directional arrow keys. The values shown on the lower position of the page change with every key press you made until they reach their maximum or minimum.
	Phase Adjusts the clock phase to reduce image distortion. 
	H. Size Adjusts the horizontal width of the image.
	Zoom Magnifies or reduces the projected image. See " Magnifying and searching for details " on page 27 for details.
	3D Settings See " Using the 3D functions " on page 37 for details.
	Color Management See " Color Management " on page 34 for details.

Function	Description	
2. PICTURE menu	Color Mode	Pre-defined picture modes are provided so you can optimize your projector image set-up to suit your program type. See " Selecting a picture mode " on page 31 for details.
	Reference Mode	Selects a picture mode that most suits your need for the image quality and further fine-tune the image based on the selections listed on the same page below. See " Setting the User 1/User 2 mode " on page 32 for details.
	Brightness	Adjusts the brightness of the image. See " Adjusting Brightness " on page 33 for details.
	Contrast	Adjusts the degree of difference between dark and light in the image. See " Adjusting Contrast " on page 33 for details.
	Color	Adjusts the color saturation level -- the amount of each color in a video image. See " Adjusting Color " on page 33 for details.
	Tint	Adjusts the red and green color tones of the image. See " Adjusting Tint " on page 33 for details.  The function is only available when Video or S-Video with NTSC system is selected.
	Sharpness	Adjusts the image to make it look sharper or softer. See " Adjusting Sharpness " on page 33 for details.
	Brilliant Color	Adjusts white peaking while maintaining correct color presentation. See " Adjusting Brilliant Color " on page 33 for details.
	Color Temperature	See " Selecting a Color Temperature " on page 33 for details.
	Save Settings	Saves the settings made for the User 1 or User 2 mode.

Function	Description
3. SOURCE menu	Quick Auto Search See "Switching input signal" on page 25 for details.
	HDMI Format
	HDMI Range See "Changing HDMI input settings" on page 25 for details.
	DynamicEco Timer Allows the projector to decrease the power consumption automatically if no input signal is detected after a set period of time.  It takes some time to initiate this function. Make sure the projector has been turned on for more than 4 minutes.
	Smart Restart Selecting On enables you to restart the projector immediately within 150 seconds after turning it off. After 150 seconds, if the projector is not turned on again, it will directly enter the standby mode.  <ul style="list-style-type: none"> •It takes some time to initiate this function. Make sure the projector has been turned on for more than 4 minutes. If the projector is resumed by using the Smart Restart feature, this function can be executed immediately. •When On is selected, the Quick Power Off function will be automatically set to "On".
	Pattern The projector can display several test patterns. It helps you adjust the image size and focus and check that the projected image is free from distortion.  Selecting User displays the picture you saved as Screen Capture.
My Button Sets a hotkey on remote control.	

Function	Description
Language	Sets the language for the On-Screen Display (OSD) menus. See "Using the menus" on page 21 for details.
Projector Position	The projector can be installed on a ceiling or behind a screen, or with one or more mirrors. See "Choosing a location" on page 12 for details.
Auto Power Off	Allows the projector to turn off automatically if no input signal is detected after a set period of time. See "Setting Auto Power Off" on page 51 for details.
Timer	<p>Blank Timer</p> <p>Sets the image blank time when the Blank feature is activated, once elapsed the image will return to the screen. See "Hiding the image" on page 36 for details.</p>
	<p>Sleep Timer</p> <p>Allows the projector to turn off automatically after a set period of time if the incoming signal is present or not.</p>
Panel Key Lock	Disables or enables all panel key functions except POWER on the projector and keys on the remote control. See "Locking control keys" on page 36 for details.
Splash Screen	Allows you to select which logo screen will be displayed during projector start-up.
Message	Selecting On displays the current information on the screen when the projector is detecting or searching for a signal.
Standby Settings	See "Using the projector in standby mode" on page 38 for details.
CEC	See "Using the CEC function" on page 37 for details.

4. SYSTEM SETTING: BASIC menu

Function	Description
High Altitude Mode	A mode for operation in high altitude areas. See "Operating in a high altitude environment" on page 36 for details.
DCR	<p>Enables or disables the DCR (Dynamic Contrast Ratio) function. Selecting On enables the function and the projector will automatically switch the lamp mode between normal and economic modes according to the input image detected.</p> <p> This function is only available when a PC source is in use.</p> <p> After enabling DCR, frequent lamp mode switching may shorten lamp life and noise level will vary during operation.</p>
Audio Settings	<p>The sound adjustments made as below will have an effect on the projector speaker. Be sure you have made a correct connection to the projector audio input/output jacks. See "Connection" on page 15 for more details.</p> <p>Mute Mutes the sound received from AUDIO IN.</p> <p>Volume Adjusts the sound level received from AUDIO IN.</p>
Menu Settings	<p>Menu Display Time Sets the length of time the OSD will remain active after your last key press. The range is from 5 to 30 seconds in 5-second increments.</p> <p>Menu Position Sets the On-Screen Display (OSD) menu position.</p>
Closed Caption	<p>Closed Caption Enable Activates the function by selecting On when the selected input signal carries closed captions.</p> <ul style="list-style-type: none"> • Captions: An on-screen display of the dialogue, narration, and sound effects of TV programs and videos that are closed captioned (usually marked as "CC" in TV listings). <p> This function is only available when a Composite video or S-Video input signal is selected and its system format is NTSC.</p> <p>Caption Version Selects a preferred closed captioning mode. To view captions, select CC1, CC2, CC3, or CC4 (CC1 displays captions in the primary language in your area).</p>
Lamp Settings	<p>Lamp Mode See "Setting Lamp Mode as Economic" on page 51 for details.</p> <p>Reset Lamp Timer See "Resetting the lamp timer" on page 55 for details.</p> <p>Equivalent Lamp Hour See "Getting to know the lamp hour" on page 51 for details on how the total lamp hour is calculated.</p>

Function	Description
5. SYSTEM SETTING: ADVANCED menu	<p>Presentation Timer Reminds the presenter to finish the presentation within a certain time frame. See "Setting the presentation timer" on page 35 for details.</p>
	<p>Security Settings See "Utilizing the password function" on page 22 for details.</p>
	<p>Remote Control Code See "Remote control code" on page 9 for details.</p>
	<p>Reset Settings Reset All Settings Returns all settings to the factory preset values.  The following settings will still remain: Keystone, Language, Projector Position, High Altitude Mode, Security Settings, Remote Control Code. Reset Color Settings Returns all color settings to the factory preset values.</p>
6. INFORMATION menu	<p>Current System Status Source Shows the current signal source. Color Mode Shows the selected mode in the PICTURE menu. Resolution Shows the native resolution of the input signal. Color System Shows input system format, NTSC, PAL, SECAM, or RGB. Equivalent Lamp Hour Displays the number of hours the lamp has been used.</p>

Maintenance

Care of the projector

Your projector needs little maintenance. The only thing you need to do on a regular basis is to keep the lens clean.

Never remove any parts of the projector except the lamp. Contact your dealer if other parts need replacing.

Cleaning the lens

Clean the lens whenever you notice dirt or dust on the surface.

- Use a canister of compressed air to remove dust.
- If there is dirt or smears, use lens-cleaning paper or moisten a soft cloth with lens cleaner and gently wipe the lens surface.

 **CAUTION**

Never rub the lens with abrasive materials.

Cleaning the projector case

Before you clean the case, turn the projector off using the proper shutdown procedure as described in "[Shutting down the projector](#)" on page 39 and unplug the power cord.

- To remove dirt or dust, wipe the case with a soft, lint-free cloth.
- To remove stubborn dirt or stains, moisten a soft cloth with water and a neutral pH detergent. Then wipe the case.

 **CAUTION**

Never use wax, alcohol, benzene, thinner or other chemical detergents. These can damage the case.

Storing the projector

If you need to store the projector for an extended time, please follow the instructions below:

- Make sure the temperature and humidity of the storage area are within the recommended range for the projector. Please refer to "[Specifications](#)" on page 58 or consult your dealer about the range.
- Retract the adjuster feet.
- Remove the battery from the remote control.
- Pack the projector in its original packing or equivalent.

Transporting the projector

It is recommended that you ship the projector with its original packing or equivalent.

Lamp information

Getting to know the lamp hour

When the projector is in operation, the duration (in hours) of lamp usage is automatically calculated by the built-in timer.

To obtain the lamp hour information:

1. Press **MENU/EXIT** on the projector or **Menu** on the remote control and then press **</>** until the **SYSTEM SETTING: ADVANCED** menu is highlighted.
2. Press **∨** to highlight **Lamp Settings** and press **MODE/ENTER** on the projector or **ENTER** on the remote control. The **Lamp Settings** page is displayed.
3. You will see the **Equivalent lamp hour** information on the menu.
4. To leave the menu, press **MENU/EXIT** on the projector or **Exit** on the remote control.

You can also get the lamp hour information on the **INFORMATION** menu.

Extending lamp life

The projection lamp is a consumable item. To keep the lamp life as long as possible, you can do the following settings via the OSD menu.

Setting Lamp Mode as Economic

Using **Economic** mode reduces system noise and power consumption by 20%. If the **Economic** mode is selected, the light output will be reduced and result in darker projected pictures.

Setting the projector in **Economic** mode also extends the lamp operation life. To set **Economic** mode, go into the **SYSTEM SETTING: ADVANCED > Lamp Settings > Lamp Mode** menu and press **</>**.

Setting Auto Power Off

This function allows the projector to turn off automatically if no input source is detected after a set period of time to prevent unnecessary waste of lamp life.

To set **Auto Power Off**, go into the **SYSTEM SETTING: BASIC > Auto Power Off** menu and press **</>**. If the preset time lengths are not suitable for your presentation, select **Disable**. The projector will not automatically shut down in a certain time period.

Timing of replacing the lamp

When the **LAMP indicator light** lights up red or a message appears suggesting it is time to replace the lamp, please install a new lamp or consult your dealer. An old lamp may cause a malfunction in the projector and in some instances the lamp may explode.

CAUTION

The **LAMP indicator light** and **TEMPerature indicator light** will light up if the lamp becomes too hot. Turn the power off and let the projector cool for 45 minutes. If the **LAMP** or **TEMP** indicator still lights up after turning the power back on, please contact your dealer. See "[Indicators](#)" on page 56 for details.

The following lamp warning displays will remind you to change the lamp.

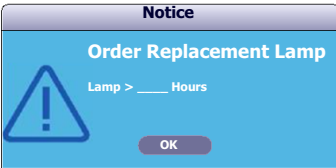
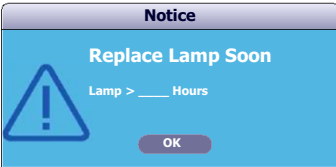
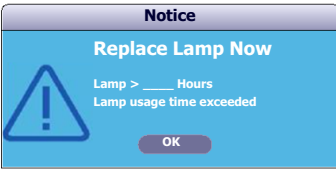
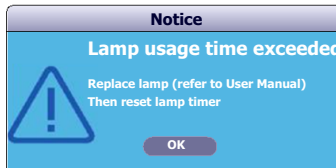
Status	Message
<p>Install a new lamp for optimal performance. If the projector is normally run with Economic selected (See "Setting Lamp Mode as Economic" on page 51), you may continue to operate the projector until the next hour lamp warning appears.</p>	 <p>The message box has a blue background and a purple header labeled 'Notice'. It contains a warning icon (triangle with exclamation mark), the text 'Order Replacement Lamp', 'Lamp > ____ Hours', and an 'OK' button.</p>
<p>A new lamp should be fitted to avoid the inconvenience when the projector runs out of lamp time.</p>	 <p>The message box has a blue background and a purple header labeled 'Notice'. It contains a warning icon, the text 'Replace Lamp Soon', 'Lamp > ____ Hours', and an 'OK' button.</p>
<p>It is strongly recommended that you replace the lamp at this age. The lamp is a consumable item. The lamp brightness diminishes with use. This is normal lamp behavior. You can replace the lamp whenever you notice that the brightness level has significantly diminished. If the lamp is not replaced beforehand, it must be replaced when you see this message.</p>	 <p>The message box has a blue background and a purple header labeled 'Notice'. It contains a warning icon, the text 'Replace Lamp Now', 'Lamp > ____ Hours', 'Lamp usage time exceeded', and an 'OK' button.</p>
<p>The lamp MUST be replaced before the projector will operate normally.</p>	 <p>The message box has a blue background and a purple header labeled 'Notice'. It contains a warning icon, the text 'Lamp usage time exceeded', 'Replace lamp (refer to User Manual)', 'Then reset lamp timer', and an 'OK' button.</p>

Replacing the lamp

To prepare a new lamp, contact your dealer and tell the lamp type number.

Type number: RLC-078 (PJD5132/PJD5232L/PJD5134/PJD5234L)

Type number: RLC-085 (PJD5533w)

WARNING

Hg - Lamp contains mercury. Manage in accordance with local disposal laws. See www.lamprecycle.org

- Be careful of broken glass when replacing the lamp.
- Please wear eye protection and gloves when performing overhead installation.
- To reduce the risk of electrical shock, always turn the projector off and disconnect the power cord before changing the lamp.
- To reduce the risk of severe burns, allow the projector to cool for at least 45 minutes before replacing the lamp.
- To reduce the risk of injuries to fingers and damage to internal components, use caution when removing lamp glass that has shattered into sharp pieces. Before replacing the lamp, clean the lamp compartment and dispose of cleaning materials. Be careful of sharp edges in the lamp compartment. Wash hands after lamp replacement.
- Only ViewSonic certified lamps are tested with this projector. Use of other lamps may cause electrical shock and fire.

1. Turn the power off and disconnect the projector from the wall socket. If the lamp is hot, avoid burns by waiting for approximately 45 minutes until the lamp has cooled.
2. Loosen the screws that secure the lamp cover on the both sides of the projector until the lamp cover loosens.

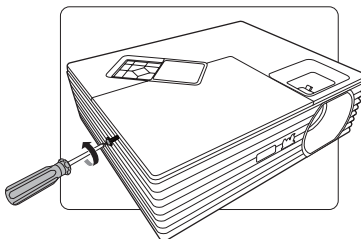

3. Remove the lamp cover from the projector.

WARNING

- Do not turn the power on with the lamp cover removed.
- Do not insert your fingers between the lamp and the projector. The sharp edges inside the projector may cause injuries.

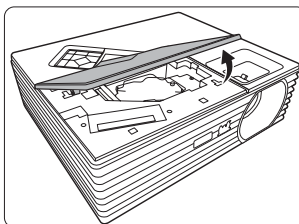

Remove and dispose of the lamp protection film.

-
4. Loosen the screw that secures the lamp.

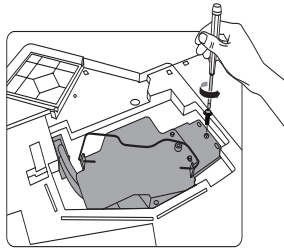

5. Disconnect the lamp's wire connector from the projector, and then lift the handle so that it stands up. Use the handle to slowly pull the lamp out of the projector.

 **CAUTION**

- **Pulling it too quickly may cause the lamp to break and scatter broken glass in the projector.**
- **Do not place the lamp in locations where water might splash on it, children can reach it, or near flammable materials.**
- **Do not insert your hands into the projector after the lamp is removed. If you touch the optical components inside, it could cause color unevenness and distortion of the projected images.**

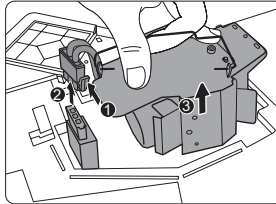

6. Insert the new lamp into the lamp compartment and make sure it fits in the projector. Connect the new lamp's wire connector to the projector.

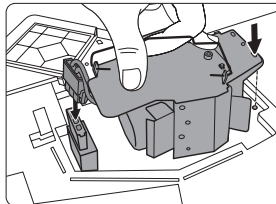

7. Tighten the screw that secures the lamp.

 **CAUTION**

- **Loose screw may cause a bad connection, which could result in malfunction.**
 - **Do not over tighten the screw.**
8. Ensure the handle is fully laid flat and locked in place.

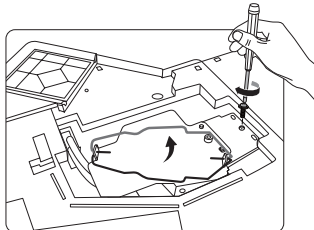

9. Place the lamp protection film supplied with the new lamp on the lamp compartment.
10. Replace the lamp cover on the projector.

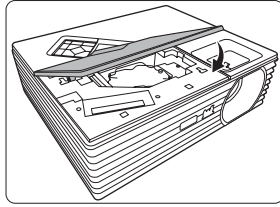

11. Tighten the screws that secure the lamp cover.

 **CAUTION**

- **Loose screw may cause a bad connection, which could result in malfunction.**
- **Do not over tighten the screws.**

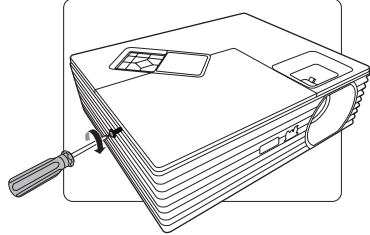

12. Restart the projector.

 **CAUTION**

Do not turn the power on with the lamp cover removed.

Resetting the lamp timer

13. After the startup logo, open the On-Screen Display (OSD) menu.
14. Go to the **SYSTEM SETTING: ADVANCED > Lamp Settings** menu. Press **MODE/ENTER** on the projector or **ENTER** on the remote control. The **Lamp Settings** page is displayed.
15. Press  to highlight **Reset lamp timer** and press **MODE/ENTER** on the projector or **ENTER** on the remote control. A warning message is displayed asking if you want to reset the lamp timer.
16. Highlight **Reset** and press **MODE/ENTER** on the projector or **ENTER** on the remote control. The lamp time will be reset to '0'.

 **CAUTION**

Do not reset if the lamp is not new or replaced as this could cause damage.

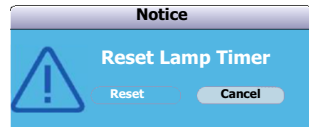

Indicators

Light			Status & Description
POWER	TEMP	LAMP	
Power events			
Blue Flashing	Off	Off	Stand-by mode
Blue	Off	Off	Powering up
Blue	Off	Off	Normal operation
Lamp events			
Purple Flashing	Off	Red	The projector has shut down automatically. If you try to re-start the projector, it will shut down again. Please contact your dealer for assistance.
Off	Off	Red	1. The projector needs 60 seconds to cool down. Or 2. Please contact your dealer for assistance.
Thermal events			
Off	Red	Off	The projector has shut down automatically. If you try to re-start the projector, it will shut down again. Please contact your dealer for assistance.
Off	Red	Red	
Off	Red	Green	
Red	Red	Red	
Red	Red	Green	
Blue	Red	Red	
Blue	Red	Green	
Purple	Red	Red	
Purple	Red	Green	
Off	Green	Red	

Troubleshooting

① The projector does not turn on.

Cause	Remedy
There is no power from the power cord.	Plug the power cord into the AC inlet on the projector, and plug the power cord into the power outlet. If the power outlet has a switch, make sure that it is switched on.
Attempting to turn the projector on again during the cooling process.	Wait until the cooling down process has completed.

① No picture

Cause	Remedy
The video source is not turned on or connected correctly.	Turn the video source on and check that the signal cable is connected correctly.
The projector is not correctly connected to the input signal device.	Check the connection.
The input signal has not been correctly selected.	Select the correct input signal with the SOURCE key on the projector or remote control.

① Blurred image

Cause	Remedy
The projection lens is not correctly focused.	Adjust the focus of the lens using the focus ring.
The projector and the screen are not aligned properly.	Adjust the projection angle and direction as well as the height of the projector if necessary.

① Remote control does not work

Cause	Remedy
The battery is out of power.	Replace the battery with a new one.
There is an obstacle between the remote control and the projector.	Remove the obstacle.
You are too far away from the projector.	Stand within 8 meters (26 feet) of the projector.

Specifications

Projector specifications

-  All specifications are subject to change without notice.
- Not all models can be purchased in your region.

General	
Product name	DLP Projector
Optical	
Resolution	PJD5132/PJD5134: 800 x 600 SVGA PJD5232L/PJD5234L: 1024 x 768 XGA PJD5533w: 1280 x 800 WXGA
Display system	1-CHIP DMD
Lamp	190 W lamp
Electrical	
Power supply	AC100–240V, 50/60 Hz (Automatic)
Power consumption	250 W (Max); < 0.5 W (Standby)
Mechanical	
Weight	2.1 Kg (4.63 lbs)
Input terminal	
Computer input	
RGB input	D-Sub 15-pin (female) x 2
Video signal input	
S-VIDEO	Mini DIN 4-pin port x 1
VIDEO	RCA jack x 1
SD/HDTV signal input	
Analog –	D-Sub <-> Component RCA jack x 3 (through RGB input)
Digital –	PJD5132/PJD5232L: N/A PJD5134/PJD5234L/PJD5533w: HDMI V1.4a x 1
Audio signal input	PC audio jack x 1

Output terminal	
RGB output	D-Sub 15-pin (female) x 1
Audio signal output	PC audio jack x 1
Speaker	2 watt x 1
Control terminal	
RS-232 serial control	9 pin x 1
LAN	N/A
USB serial control	Type mini B
IR receiver	x 1 (Front)
Environmental Requirements	
Operating temperature	0°C–40°C at sea level
Operating relative humidity	10%–90% (without condensation)
Operating altitude	<ul style="list-style-type: none"> • 0–1499 m at 5°C–35°C • 1500–3000 m at 5°C–25°C (with High Altitude Mode on)

Dimensions

268 mm (W) x 84.4 mm (H) x 221 mm (D) (Excluding extrusions)

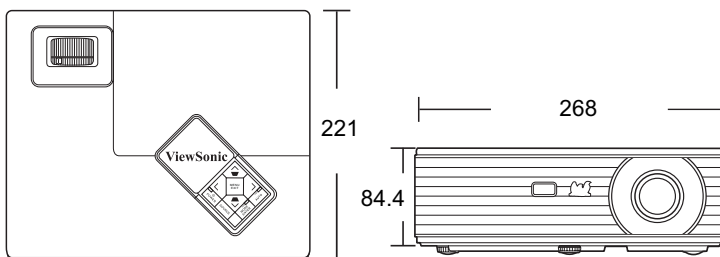

Ceiling mount installation

⊙ Ceiling mount screws:
M4 x 8 (Max. L = 8 mm)

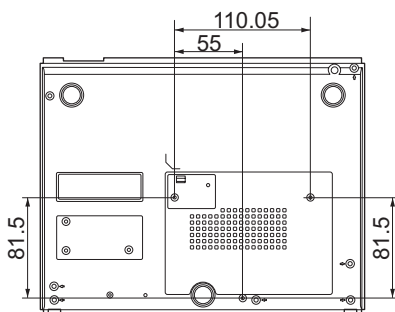

Unit: mm

Timing chart

Supported timing for PC input

Resolution	Horizontal Frequency (kHz)	Vertical Frequency (Hz)	Pixel Frequency (MHz)	Mode
720 x 400	31.469	70.087	28.3221	720 x 400_70
640 x 480	31.469	59.94	25.175	VGA_60
	37.861	72.809	31.5	VGA_72
	37.5	75	31.5	VGA_75
	43.269	85.008	36	VGA_85
	61.91	119.518	52.5	VGA_120
800 x 600	35.156	56.250	36	SVGA_56
	37.879	60.317	40	SVGA_60
	48.077	72.188	50	SVGA_72
	46.875	75	49.5	SVGA_75
	53.674	85.061	56.25	SVGA_85
	30.99	49.916	30.75	SVGA_50
	77.425	119.854	83	SVGA_120
1024 x 768	48.363	60.004	65	XGA_60
	56.476	70.069	75	XGA_70
	60.023	75.029	78.75	XGA_75
	68.667	84.997	94.5	XGA_85
	39.634	49.98	52	XGA_50
	98.958	119.804	137.75	XGA_120
1280 x 800	49.702	59.81	83.5	WXGA_60
	62.795	74.934	106.5	WXGA_75
	71.554	84.88	122.5	WXGA_85
1280 x 1024	63.981	60.02	108.000	SXGA_60
	79.976	75.025	135.000	SXGA_75
	91.146	85.024	157.500	SXGA_85
1280 x 960	60	60	108	1280 x 960_60
1400 x 1050	65.317	59.978	121.75	SXGA+_60
1600 x 1200	75	60	162	UXGA
640 x 480@67Hz	35	66.667	30.24	MAC13
832 x 624@75Hz	49.722	74.546	57.28	MAC16
1152 x 870@75Hz	68.68	75.06	100	MAC21

Supported timing for Component-YPbPr input

Signal Format	Horizontal Frequency (kHz)	Vertical Frequency (Hz)
480i(525i)@60Hz	15.73	59.94
480p(525p)@60Hz	31.47	59.94
576i(625i)@50Hz	15.63	50.00
576p(625p)@50Hz	31.25	50.00
720p(750p)@60Hz	45.00	60.00
720p(750p)@50Hz	37.50	50.00
1080i(1125i)@60Hz	33.75	60.00
1080i(1125i)@50Hz	28.13	50.00
1080P@60Hz	67.5	60
1080P@50Hz	56.25	50

 Displaying a 1080i(1125i)@60Hz or 1080i(1125i)@50Hz signal may result in slight image vibration.

Supported timing for Video and S-Video inputs

Video mode	Horizontal Frequency (kHz)	Vertical Frequency (Hz)	Color sub-carrier Frequency (MHz)
NTSC	15.73	60	3.58
PAL	15.63	50	4.43
SECAM	15.63	50	4.25 or 4.41
PAL-M	15.73	60	3.58
PAL-N	15.63	50	3.58
PAL-60	15.73	60	4.43
NTSC4.43	15.73	60	4.43

Copyright information

Copyright

Copyright 2012. All rights reserved. No part of this publication may be reproduced, transmitted, transcribed, stored in a retrieval system or translated into any language or computer language, in any form or by any means, electronic, mechanical, magnetic, optical, chemical, manual or otherwise, without the prior written permission of ViewSonic Corporation.

Disclaimer

ViewSonic Corporation makes no representations or warranties, either expressed or implied, with respect to the contents hereof and specifically disclaims any warranties, merchantability or fitness for any particular purpose. Further, ViewSonic Corporation reserves the right to revise this publication and to make changes from time to time in the contents hereof without obligation to notify any person of such revision or changes.

*DLP and Digital Micromirror Device (DMD) are trademarks of Texas Instruments. Others are copyrights of their respective companies or organizations.

Appendix

IR control table

Code A

Key	Format	Byte1	Byte2	Byte3	Byte4
Power	NEC	83	F4	17	E8
Auto Sync	NEC	83	F4	08	F7
VGA	NEC	83	F4	41	BE
Video	NEC	83	F4	52	AD
Source	NEC	83	F4	04	FB
Color Mode	NEC	83	F4	10	EF
Up / KeyS +	NEC	83	F4	0B	F4
Left	NEC	83	F4	0E	F1
Enter	NEC	83	F4	15	EA
Right	NEC	83	F4	0F	F0
Down / KeyS -	NEC	83	F4	0C	F3
Menu	NEC	83	F4	30	CF
My Button	NEC	83	F4	56	A9
Exit	NEC	83	F4	28	D7
Mouse L key	NEC	83	F4	36	C9
Mouse R key	NEC	83	F4	37	C8
PgUp	NEC	83	F4	05	FA
PgDn	NEC	83	F4	06	F9
Mouse	NEC	83	F4	31	CE
Magnify	NEC	83	F4	32	CD
Volume +	NEC	83	F4	82	7D
Volume -	NEC	83	F4	83	7C
Panel Key Lock	NEC	83	F4	57	A8
Freeze	NEC	83	F4	03	FC
Pattern	NEC	83	F4	55	AA
Blank	NEC	83	F4	07	F8
Mute	NEC	83	F4	14	EB
DynamicEco™	NEC	83	F4	2B	D4
Timer	NEC	83	F4	27	D8
Aspect	NEC	83	F4	13	EC

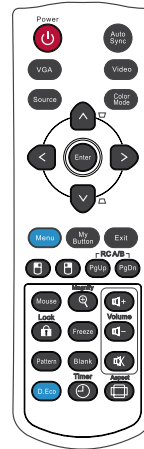

Code B

Key	Format	Byte1	Byte2	Byte3	Byte4
Power	NEC	83	F4	60	9F
Auto Sync	NEC	83	F4	63	9C
VGA	NEC	83	F4	64	9B
Video	NEC	83	F4	66	99
Source	NEC	83	F4	7D	82
Color Mode	NEC	83	F4	9E	61
Up / KeyS +	NEC	83	F4	67	98
Left	NEC	83	F4	69	96
Enter	NEC	83	F4	6B	94
Right	NEC	83	F4	6A	95
Down / KeyS -	NEC	83	F4	68	97
Menu	NEC	83	F4	6C	93
My Button	NEC	83	F4	6D	92
Exit	NEC	83	F4	6E	91
Mouse L key	NEC	83	F4	38	C7
Mouse R key	NEC	83	F4	39	C6
PgUp	NEC	83	F4	5C	A3
PgDn	NEC	83	F4	5D	A2
Mouse	NEC	83	F4	9B	64
Magnify	NEC	83	F4	99	66
Volume +	NEC	83	F4	5A	A5
Volume -	NEC	83	F4	5B	A4
Panel Key Lock	NEC	83	F4	5E	A1
Freeze	NEC	83	F4	61	9E
Pattern	NEC	83	F4	7E	81
Blank	NEC	83	F4	62	9D
Mute	NEC	83	F4	9D	62
DynamicEco™	NEC	83	F4	7F	80
Timer	NEC	83	F4	9C	63
Aspect	NEC	83	F4	9A	65

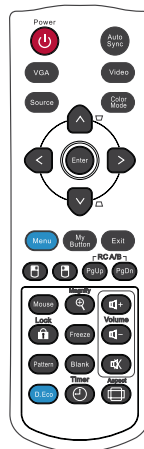

RS232 command table

<Pin assignment for this two end>

Pin	Description	Pin	Description
1	NC	2	RX
3	TX	4	NC
5	GND	6	NC
7	RTSZ	8	CTSZ
9	NC		

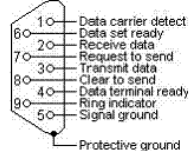

<Interface>

RS-232 protocol	
Baud Rate	115200 bps (default)
Data Length	8 bit
Parity Check	None
Stop Bit	1 bit
Flow Control	None

<RS232 command table>

Function	Status	Action	cmd
Power	Write	Turn on	0x06 0x14 0x00 0x04 0x00 0x34 0x11 0x00 0x00 0x5D
		Turn off	0x06 0x14 0x00 0x04 0x00 0x34 0x11 0x01 0x00 0x5E
	Read	Power status (on/off)	0x07 0x14 0x00 0x05 0x00 0x34 0x00 0x00 0x11 0x00 0x5E
Reset		Execute	0x06 0x14 0x00 0x04 0x00 0x34 0x11 0x02 0x00 0x5F
Reset Color Settings		Execute	0x06 0x14 0x00 0x04 0x00 0x34 0x11 0x2A 0x00 0x87
Splash Screen	Write	Splash Screen Black	0x06 0x14 0x00 0x04 0x00 0x34 0x11 0x0A 0x00 0x67
		Splash Screen Blue	0x06 0x14 0x00 0x04 0x00 0x34 0x11 0x0A 0x01 0x68
		Splash Screen ViewSonic	0x06 0x14 0x00 0x04 0x00 0x34 0x11 0x0A 0x02 0x69
		Splash Screen Off	0x06 0x14 0x00 0x04 0x00 0x34 0x11 0x0A 0x04 0x6B
	Read	Splash Screen status	0x07 0x14 0x00 0x05 0x00 0x34 0x00 0x00 0x11 0x0A 0x68
Quick Power Off	Write	Quick Power Off Off	0x06 0x14 0x00 0x04 0x00 0x34 0x11 0x0B 0x00 0x68
		Quick Power Off On	0x06 0x14 0x00 0x04 0x00 0x34 0x11 0x0B 0x01 0x69
	Read	Quick Power Off status	0x07 0x14 0x00 0x05 0x00 0x34 0x00 0x00 0x11 0x0B 0x69
High Altitude Mode	Write	High Altitude Mode Off	0x06 0x14 0x00 0x04 0x00 0x34 0x11 0x0C 0x00 0x69
		High Altitude Mode On	0x06 0x14 0x00 0x04 0x00 0x34 0x11 0x0C 0x01 0x6A
	Read	High Altitude Mode status	0x07 0x14 0x00 0x05 0x00 0x34 0x00 0x00 0x11 0x0C 0x6A
Lamp Mode	Write	Lamp Mode Normal	0x06 0x14 0x00 0x04 0x00 0x34 0x11 0x10 0x00 0x6D
		Lamp Mode Economic	0x06 0x14 0x00 0x04 0x00 0x34 0x11 0x10 0x01 0x6E
	Read	Lamp Mode status	0x07 0x14 0x00 0x05 0x00 0x34 0x00 0x00 0x11 0x10 0x6E
Message	Write	Message Off	0x06 0x14 0x00 0x04 0x00 0x34 0x11 0x27 0x00 0x84
		Message On	0x06 0x14 0x00 0x04 0x00 0x34 0x11 0x27 0x01 0x85
	Read	Message status	0x07 0x14 0x00 0x05 0x00 0x34 0x00 0x00 0x11 0x27 0x85

Projector Position	Write	Front Table	0x06 0x14 0x00 0x04 0x00 0x34 0x12 0x00 0x00 0x5E
		Rear Table	0x06 0x14 0x00 0x04 0x00 0x34 0x12 0x00 0x01 0x5F
		Rear Ceiling	0x06 0x14 0x00 0x04 0x00 0x34 0x12 0x00 0x02 0x60
		Front Ceiling	0x06 0x14 0x00 0x04 0x00 0x34 0x12 0x00 0x03 0x61
	Read	Projector position status	0x07 0x14 0x00 0x05 0x00 0x34 0x00 0x00 0x12 0x00 0x5F
3D Sync	Write	OFF	0x06 0x14 0x00 0x04 0x00 0x34 0x12 0x20 0x00 0x7E
		Auto	0x06 0x14 0x00 0x04 0x00 0x34 0x12 0x20 0x01 0x7F
		Frame Sequential	0x06 0x14 0x00 0x04 0x00 0x34 0x12 0x20 0x02 0x80
		Frame Packing	0x06 0x14 0x00 0x04 0x00 0x34 0x12 0x20 0x03 0x81
		Top-Bottom	0x06 0x14 0x00 0x04 0x00 0x34 0x12 0x20 0x04 0x82
	Side-by-Side	0x06 0x14 0x00 0x04 0x00 0x34 0x12 0x20 0x05 0x83	
Read	3D Sync Status	0x07 0x14 0x00 0x05 0x00 0x34 0x00 0x00 0x12 0x20 0x7F	
3D Sync Invert	Write	Off	0x06 0x14 0x00 0x04 0x00 0x34 0x12 0x21 0x00 0x7F
		On	0x06 0x14 0x00 0x04 0x00 0x34 0x12 0x21 0x01 0x80
	Read	3D Sync Invert Status	0x07 0x14 0x00 0x05 0x00 0x34 0x00 0x00 0x12 0x21 0x80
Contrast	Write	Contrast decrease	0x06 0x14 0x00 0x04 0x00 0x34 0x12 0x02 0x00 0x60
		Contrast increase	0x06 0x14 0x00 0x04 0x00 0x34 0x12 0x02 0x01 0x61
	Read	Contrast ratio	0x07 0x14 0x00 0x05 0x00 0x34 0x00 0x00 0x12 0x02 0x61
Brightness	Write	Brightness decrease	0x06 0x14 0x00 0x04 0x00 0x34 0x12 0x03 0x00 0x61
		Brightness increase	0x06 0x14 0x00 0x04 0x00 0x34 0x12 0x03 0x01 0x62
	Read	Brightness	0x07 0x14 0x00 0x05 0x00 0x34 0x00 0x00 0x12 0x03 0x62
Aspect ratio	Write	Aspect ratio Auto	0x06 0x14 0x00 0x04 0x00 0x34 0x12 0x04 0x00 0x62
		Aspect ratio 4:3	0x06 0x14 0x00 0x04 0x00 0x34 0x12 0x04 0x02 0x64
		Aspect ratio 16:9	0x06 0x14 0x00 0x04 0x00 0x34 0x12 0x04 0x03 0x65
		Aspect ratio 16:10	0x06 0x14 0x00 0x04 0x00 0x34 0x12 0x04 0x04 0x66
	Aspect ratio Wide	0x06 0x14 0x00 0x04 0x00 0x34 0x12 0x04 0x06 0x68	
Read	Aspect ratio	0x07 0x14 0x00 0x05 0x00 0x34 0x00 0x00 0x12 0x04 0x63	
Auto Adjust	Execute		0x06 0x14 0x00 0x04 0x00 0x34 0x12 0x05 0x00 0x63
Horizontal position	Write	Horizontal position shift right	0x06 0x14 0x00 0x04 0x00 0x34 0x12 0x06 0x01 0x65
		Horizontal position shift left	0x06 0x14 0x00 0x04 0x00 0x34 0x12 0x06 0x00 0x64
	Read	Horizontal position	0x07 0x14 0x00 0x05 0x00 0x34 0x00 0x00 0x12 0x06 0x65
Vertical position	Write	Vertical position shift up	0x06 0x14 0x00 0x04 0x00 0x34 0x12 0x07 0x00 0x65
		Vertical position shift down	0x06 0x14 0x00 0x04 0x00 0x34 0x12 0x07 0x01 0x66
	Read	read Vertical position	0x07 0x14 0x00 0x05 0x00 0x34 0x00 0x00 0x12 0x07 0x66

Color temperature	Write	Color temperatureT1	0x06 0x14 0x00 0x04 0x00 0x34 0x12 0x08 0x00 0x66
		Color temperatureT2	0x06 0x14 0x00 0x04 0x00 0x34 0x12 0x08 0x01 0x67
		Color temperatureT3	0x06 0x14 0x00 0x04 0x00 0x34 0x12 0x08 0x02 0x68
		Color temperatureT4	0x06 0x14 0x00 0x04 0x00 0x34 0x12 0x08 0x03 0x69
	Read	Color temperature status	0x07 0x14 0x00 0x05 0x00 0x34 0x00 0x00 0x12 0x08 0x67
Blank	Write	Blank on	0x06 0x14 0x00 0x04 0x00 0x34 0x12 0x09 0x01 0x68
		Blank off	0x06 0x14 0x00 0x04 0x00 0x34 0x12 0x09 0x00 0x67
	Read	Blank status	0x07 0x14 0x00 0x05 0x00 0x34 0x00 0x00 0x12 0x09 0x68
Keystone-Vertical	Write	Decrease	0x06 0x14 0x00 0x04 0x00 0x34 0x12 0x0A 0x00 0x68
		Increase	0x06 0x14 0x00 0x04 0x00 0x34 0x12 0x0A 0x01 0x69
	Read	Keystone status	0x07 0x14 0x00 0x05 0x00 0x34 0x00 0x00 0x12 0x0A 0x69
Color mode	Write	Brightest	0x06 0x14 0x00 0x04 0x00 0x34 0x12 0x0B 0x00 0x69
		Movie	0x06 0x14 0x00 0x04 0x00 0x34 0x12 0x0B 0x01 0x6A
		User 1	0x06 0x14 0x00 0x04 0x00 0x34 0x12 0x0B 0x02 0x6B
		User 2	0x06 0x14 0x00 0x04 0x00 0x34 0x12 0x0B 0x03 0x6C
		PC / Gaming	0x06 0x14 0x00 0x04 0x00 0x34 0x12 0x0B 0x04 0x6D
		ViewMatch	0x06 0x14 0x00 0x04 0x00 0x34 0x12 0x0B 0x05 0x6E
		Dynamic PC	0x06 0x14 0x00 0x04 0x00 0x34 0x12 0x0B 0x06 0x6F
		Dynamic Movie	0x06 0x14 0x00 0x04 0x00 0x34 0x12 0x0B 0x07 0x70
	Read	Preset mode status	0x07 0x14 0x00 0x05 0x00 0x34 0x00 0x00 0x12 0x0B 0x6A
Primary Color	Write	Primary color R	0x06 0x14 0x00 0x04 0x00 0x34 0x12 0x10 0x00 0x6E
		Primary color G	0x06 0x14 0x00 0x04 0x00 0x34 0x12 0x10 0x01 0x6F
		Primary color B	0x06 0x14 0x00 0x04 0x00 0x34 0x12 0x10 0x02 0x70
		Primary color C	0x06 0x14 0x00 0x04 0x00 0x34 0x12 0x10 0x03 0x71
		Primary color M	0x06 0x14 0x00 0x04 0x00 0x34 0x12 0x10 0x04 0x72
		Primary color Y	0x06 0x14 0x00 0x04 0x00 0x34 0x12 0x10 0x05 0x73
	Read	Primary color status	0x07 0x14 0x00 0x05 0x00 0x34 0x00 0x00 0x12 0x10 0x6F
Hue	Write	Hue decrease	0x06 0x14 0x00 0x04 0x00 0x34 0x12 0x11 0x00 0x6F
		Hue increase	0x06 0x14 0x00 0x04 0x00 0x34 0x12 0x11 0x01 0x70
	Read	Hue	0x07 0x14 0x00 0x05 0x00 0x34 0x00 0x00 0x12 0x11 0x70
Saturation	Write	Saturation decrease	0x06 0x14 0x00 0x04 0x00 0x34 0x12 0x12 0x00 0x70
		Saturation increase	0x06 0x14 0x00 0x04 0x00 0x34 0x12 0x12 0x01 0x71
	Read	Saturation	0x07 0x14 0x00 0x05 0x00 0x34 0x00 0x00 0x12 0x12 0x71
Gain	Write	Gain decrease	0x06 0x14 0x00 0x04 0x00 0x34 0x12 0x13 0x00 0x71
		Gain increase	0x06 0x14 0x00 0x04 0x00 0x34 0x12 0x13 0x01 0x72
	Read	Gain	0x07 0x14 0x00 0x05 0x00 0x34 0x00 0x00 0x12 0x13 0x72
Freeze	Write	Freeze on	0x06 0x14 0x00 0x04 0x00 0x34 0x13 0x00 0x01 0x60
		Freeze off	0x06 0x14 0x00 0x04 0x00 0x34 0x13 0x00 0x00 0x5F
	Read	Freeze status	0x07 0x14 0x00 0x05 0x00 0x34 0x00 0x00 0x13 0x00 0x60

Source input	Write	Input source VGA	0x06 0x14 0x00 0x04 0x00 0x34 0x13 0x01 0x00 0x60
		Input source VGA2	0x06 0x14 0x00 0x04 0x00 0x34 0x13 0x01 0x08 0x68
		Input source Composite	0x06 0x14 0x00 0x04 0x00 0x34 0x13 0x01 0x05 0x65
		Input source SVIDEO	0x06 0x14 0x00 0x04 0x00 0x34 0x13 0x01 0x06 0x66
		Input source HDMI	0x06 0x14 0x00 0x04 0x00 0x34 0x13 0x01 0x03 0x63
	Read	Source	0x07 0x14 0x00 0x05 0x00 0x34 0x00 0x00 0x13 0x01 0x61
Quick Auto Search	Write	Quick Auto Search on	0x06 0x14 0x00 0x04 0x00 0x34 0x13 0x02 0x01 0x62
		Quick Auto Search off	0x06 0x14 0x00 0x04 0x00 0x34 0x13 0x02 0x00 0x61
	Read	Quick Auto Search status	0x07 0x14 0x00 0x05 0x00 0x34 0x00 0x00 0x13 0x02 0x62
HDMI Format	Write	RGB	0x06 0x14 0x00 0x04 0x00 0x34 0x11 0x28 0x00 0x85
		YUV	0x06 0x14 0x00 0x04 0x00 0x34 0x11 0x28 0x01 0x86
		Auto	0x06 0x14 0x00 0x04 0x00 0x34 0x11 0x28 0x02 0x87
	Read	HDMI Fomrat status	0x07 0x14 0x00 0x05 0x00 0x34 0x00 0x00 0x11 0x28 0x86
HDMI Range	Write	Enhanced	0x06 0x14 0x00 0x04 0x00 0x34 0x11 0x29 0x00 0x86
		Normal	0x06 0x14 0x00 0x04 0x00 0x34 0x11 0x29 0x01 0x87
	Read	HDMI Range status	0x07 0x14 0x00 0x05 0x00 0x34 0x00 0x00 0x11 0x29 0x87
Mute	Write	Mute on	0x06 0x14 0x00 0x04 0x00 0x34 0x14 0x00 0x01 0x61
		Mute off	0x06 0x14 0x00 0x04 0x00 0x34 0x14 0x00 0x00 0x60
	Read	Mute status	0x07 0x14 0x00 0x05 0x00 0x34 0x00 0x00 0x14 0x00 0x61
Volume	Write	Increase Volume	0x06 0x14 0x00 0x04 0x00 0x34 0x14 0x01 0x00 0x61
		Decrease Volume	0x06 0x14 0x00 0x04 0x00 0x34 0x14 0x02 0x00 0x62
	Read	Volume	0x07 0x14 0x00 0x05 0x00 0x34 0x00 0x00 0x14 0x03 0x64

Language	Write	ENGLISH	0x06 0x14 0x00 0x04 0x00 0x34 0x15 0x00 0x00 0x61
		FRANÇAIS	0x06 0x14 0x00 0x04 0x00 0x34 0x15 0x00 0x01 0x62
		DEUTSCH	0x06 0x14 0x00 0x04 0x00 0x34 0x15 0x00 0x02 0x63
		ITALIANO	0x06 0x14 0x00 0x04 0x00 0x34 0x15 0x00 0x03 0x64
		ESPAÑOL	0x06 0x14 0x00 0x04 0x00 0x34 0x15 0x00 0x04 0x65
		РУССКИЙ	0x06 0x14 0x00 0x04 0x00 0x34 0x15 0x00 0x05 0x66
		繁體中文	0x06 0x14 0x00 0x04 0x00 0x34 0x15 0x00 0x06 0x67
		简体中文	0x06 0x14 0x00 0x04 0x00 0x34 0x15 0x00 0x07 0x68
		日本語	0x06 0x14 0x00 0x04 0x00 0x34 0x15 0x00 0x08 0x69
		한국어	0x06 0x14 0x00 0x04 0x00 0x34 0x15 0x00 0x09 0x6A
		Svenska	0x06 0x14 0x00 0x04 0x00 0x34 0x15 0x00 0x0a 0x6B
		Nederlands	0x06 0x14 0x00 0x04 0x00 0x34 0x15 0x00 0x0b 0x6C
		Türkçe	0x06 0x14 0x00 0x04 0x00 0x34 0x15 0x00 0x0c 0x6D
		Čeština	0x06 0x14 0x00 0x04 0x00 0x34 0x15 0x00 0x0d 0x6E
		Português	0x06 0x14 0x00 0x04 0x00 0x34 0x15 0x00 0x0e 0x6F
		فارسی	0x06 0x14 0x00 0x04 0x00 0x34 0x15 0x00 0x0f 0x70
		Polski	0x06 0x14 0x00 0x04 0x00 0x34 0x15 0x00 0x10 0x71
		Suomi	0x06 0x14 0x00 0x04 0x00 0x34 0x15 0x00 0x11 0x72
		العربية	0x06 0x14 0x00 0x04 0x00 0x34 0x15 0x00 0x12 0x73
	Indonesian	0x06 0x14 0x00 0x04 0x00 0x34 0x15 0x00 0x13 0x74	
हिन्दी	0x06 0x14 0x00 0x04 0x00 0x34 0x15 0x00 0x14 0x75		
Lamp Time	Read	Language	0x07 0x14 0x00 0x05 0x00 0x34 0x00 0x00 0x15 0x00 0x62
	Write	Reset Lamp usage hour	0x06 0x14 0x00 0x04 0x00 0x34 0x15 0x01 0x00 0x62
	Read	Lamp usage hour	0x07 0x14 0x00 0x05 0x00 0x34 0x00 0x00 0x15 0x01 0x63
Error status	Read	Read error status	0x07 0x14 0x00 0x05 0x00 0x34 0x00 0x00 0x0C 0x0D 0x66

Customer Support

For technical support or product service, see the table below or contact your reseller.

Note : You will need the product serial number.

Country/Region	Website	T = Telephone F = FAX	Email
Australia/New Zealand	www.viewsonic.com.au	AUS= 1800 880 818 NZ= 0800 008 822	service@au.viewsonic.com
Canada	www.viewsonic.com	T (Toll-Free)= 1-866-463-4775 T (Toll)= 1-424-233-2533 F= 1-909-468-3757	service.ca@viewsonic.com
Europe	www.viewsoniceurope.com	www.viewsoniceurope.com/uk/support/call-desk/	
Hong Kong	www.hk.viewsonic.com	T= 852 3102 2900	service@hk.viewsonic.com
India	www.in.viewsonic.com	T= 1800 266 0101	service@in.viewsonic.com
Korea	www.kr.viewsonic.com	T= 080 333 2131	service@kr.viewsonic.com
Latin America (Argentina)	www.viewsonic.com/la/	T= 0800-4441185	soporte@viewsonic.com
Latin America (Chile)	www.viewsonic.com/la/	T= 1230-020-7975	soporte@viewsonic.com
Latin America (Columbia)	www.viewsonic.com/la/	T= 01800-9-157235	soporte@viewsonic.com
Latin America (Mexico)	www.viewsonic.com/la/	T= 001-8882328722	soporte@viewsonic.com
Renta y Datos, 29 SUR 721, COL. LA PAZ, 72160 PUEBLA, PUE. Tel: 01.222.891.55.77 CON 10 LINEAS Electroser, Av Reforma No. 403Gx39 y 41, 97000 Mérida, Yucatán. Tel: 01.999.925.19.16 Other places please refer to http://www.viewsonic.com/la/soporte/index.htm#Mexico			
Latin America (Peru)	www.viewsonic.com/la/	T= 0800-54565	soporte@viewsonic.com
Macau	www.hk.viewsonic.com	T= 853 2870 0303	service@hk.viewsonic.com
Middle East	ap.viewsonic.com/me/	Contact your reseller	service@ap.viewsonic.com
Puerto Rico & Virgin Islands	www.viewsonic.com	T= 1-800-688-6688 (English) T= 1-866-379-1304 (Spanish) F= 1-909-468-3757	service.us@viewsonic.com soporte@viewsonic.com
Singapore/Malaysia/ Thailand	www.viewsonic.com.sg	T= 65 6461 6044	service@sg.viewsonic.com
South Africa	ap.viewsonic.com/za/	Contact your reseller	service@ap.viewsonic.com
United States	www.viewsonic.com	T (Toll-Free)= 1-800-688-6688 T (Toll)= 1-424-233-2530 F= 1-909-468-3757	service.us@viewsonic.com

Limited Warranty

ViewSonic® Projector

What the warranty covers:

ViewSonic warrants its products to be free from defects in material and workmanship, under normal use, during the warranty period. If a product proves to be defective in material or workmanship during the warranty period, ViewSonic will, at its sole option, repair or replace the product with a like product. Replacement product or parts may include remanufactured or refurbished parts or components.

Limited Three (3) year General Warranty

Subject to the more limited one (1) year warranty set out below, North and South America: Three (3) years warranty for all parts excluding the lamp, three (3) years for labor, and one (1) year for the original lamp from the date of the first consumer purchase.

Other regions or countries: Please check with your local dealer or local ViewSonic office for the warranty information.

Limited One (1) year Heavy Usage Warranty:

Under heavy usage settings, where a projector's use includes more than fourteen (14) hours average daily usage, North and South America: One (1) year warranty for all parts excluding the lamp, one (1) year for labor, and ninety (90) days for the original lamp from the date of the first consumer purchase; Europe: One (1) year warranty for all parts excluding the lamp, one (1) year for labor, and ninety (90) days for the original lamp from the date of the first consumer purchase. Other regions or countries: Please check with your local dealer or local ViewSonic office for the warranty information.

Lamp warranty subject to terms and conditions, verification and approval. Applies to manufacturer's installed lamp only. All accessory lamps purchased separately are warranted for 90 days.

Who the warranty protects:

This warranty is valid only for the first consumer purchaser.

What the warranty does not cover:

1. Any product on which the serial number has been defaced, modified or removed.
2. Damage, deterioration, failure, or malfunction resulting from:
 - a. Accident, abuse, misuse, neglect, fire, water, lightning, or other acts of nature, improper maintenance, unauthorized product modification, or failure to follow instructions supplied with the product.
 - b. Operation outside of product specifications.
 - c. Operation of the product for other than the normal intended use or not under normal conditions.
 - d. Repair or attempted repair by anyone not authorized by ViewSonic.
 - e. Any damage of the product due to shipment.
 - f. Removal or installation of the product.
 - g. Causes external to the product, such as electric power fluctuations or failure.
 - h. Use of supplies or parts not meeting ViewSonic's specifications.
 - i. Normal wear and tear.
 - j. Any other cause which does not relate to a product defect.
3. Removal, installation, and set-up service charges.

How to get service:

1. For information about receiving service under warranty, contact ViewSonic Customer Support (please refer to "Customer Support" page). You will need to provide your product's serial number.
2. To obtain warranted service, you will be required to provide (a) the original dated sales slip, (b) your name, (c) your address, (d) a description of the problem, and (e) the serial number of the product.
3. Take or ship the product freight prepaid in the original container to an authorized ViewSonic service center or ViewSonic.
4. For additional information or the name of the nearest ViewSonic service center, contact ViewSonic.

Limitation of implied warranties:

There are no warranties, express or implied, which extend beyond the description contained herein including the implied warranty of merchantability and fitness for a particular purpose.

Exclusion of damages:

ViewSonic's liability is limited to the cost of repair or replacement of the product. ViewSonic shall not be liable for:

1. Damage to other property caused by any defects in the product, damages based upon inconvenience, loss of use of the product, loss of time, loss of profits, loss of business opportunity, loss of goodwill, interference with business relationships, or other commercial loss, even if advised of the possibility of such damages.
2. Any other damages, whether incidental, consequential or otherwise.
3. Any claim against the customer by any other party.

Effect of local law:

This warranty gives you specific legal rights, and you may also have other rights which vary from local authority. Some local governances do not allow limitations on implied warranties and/or do not allow the exclusion of incidental or consequential damages, so the above limitations and exclusions may not apply to you.

Sales outside the U.S.A. and Canada:

For warranty information and service on ViewSonic products sold outside of the U.S.A. and Canada, contact ViewSonic or your local ViewSonic dealer.

The warranty period for this product in mainland China (Hong Kong, Macao and Taiwan Excluded) is subject to the terms and conditions of the Maintenance Guarantee Card.

For users in Europe and Russia, full details of warranty provided can be found in www.viewsoniceurope.com under Support/Warranty Information.

Mexico Limited Warranty

ViewSonic® Projector

What the warranty covers:

ViewSonic warrants its products to be free from defects in material and workmanship, under normal use, during the warranty period. If a product proves to be defective in material or workmanship during the warranty period, ViewSonic will, at its sole option, repair or replace the product with a like product. Replacement product or parts may include remanufactured or refurbished parts or components & accessories.

How long the warranty is effective:

3 years for all parts excluding the lamp, 3 years for labor, 1 year for the original lamp from the date of the first consumer purchase.

Lamp warranty subject to terms and conditions, verification and approval. Applies to manufacturer's installed lamp only.

All accessory lamps purchased separately are warranted for 90 days.

Who the warranty protects:

This warranty is valid only for the first consumer purchaser.

What the warranty does not cover:

1. Any product on which the serial number has been defaced, modified or removed.
2. Damage, deterioration or malfunction resulting from:
 - a. Accident, misuse, neglect, fire, water, lightning, or other acts of nature, unauthorized product modification, unauthorized attempted repair, or failure to follow instructions supplied with the product.
 - b. Any damage of the product due to shipment.
 - c. Causes external to the product, such as electrical power fluctuations or failure.
 - d. Use of supplies or parts not meeting ViewSonic's specifications.
 - e. Normal wear and tear.
 - f. Any other cause which does not relate to a product defect.
3. Any product exhibiting a condition commonly known as "image burn-in" which results when a static image is displayed on the product for an extended period of time.
4. Removal, installation, insurance, and set-up service charges.

How to get service:

For information about receiving service under warranty, contact ViewSonic Customer Support (Please refer to the attached Customer Support page). You will need to provide your product's serial number, so please record the product information in the space provided below on your purchase for your future use. Please retain your receipt of proof of purchase to support your warranty claim.

For Your Records

Product Name: _____ Model Number: _____
Document Number: _____ Serial Number: _____
Purchase Date: _____ Extended Warranty Purchase? _____ (Y/N)
If so, what date does warranty expire? _____

1. To obtain warranty service, you will be required to provide (a) the original dated sales slip, (b) your name, (c) your address, (d) a description of the problem, and (e) the serial number of the product.
2. Take or ship the product in the original container packaging to an authorized ViewSonic service center.
3. Round trip transportation costs for in-warranty products will be paid by ViewSonic.

Limitation of implied warranties:

There are no warranties, express or implied, which extend beyond the description contained herein including the implied warranty of merchantability and fitness for a particular purpose.

Exclusion of damages:

ViewSonic's liability is limited to the cost of repair or replacement of the product. ViewSonic shall not be liable for:

1. Damage to other property caused by any defects in the product, damages based upon inconvenience, loss of use of the product, loss of time, loss of profits, loss of business opportunity, loss of goodwill, interference with business relationships, or other commercial loss, even if advised of the possibility of such damages.
2. Any other damages, whether incidental, consequential or otherwise.
3. Any claim against the customer by any other party.
4. Repair or attempted repair by anyone not authorized by ViewSonic.

Contact Information for Sales & Authorized Service (Centro Autorizado de Servicio) within Mexico:	
Name, address, of manufacturer and importers: México, Av. de la Palma #8 Piso 2 Despacho 203, Corporativo Interpalmas, Col. San Fernando Huixquilucan, Estado de México Tel: (55) 3605-1099 http://www.viewsonic.com/la/soporte/index.htm	
NÚMERO GRATIS DE ASISTENCIA TÉCNICA PARA TODO MÉXICO: 001.866.823.2004	
Hermosillo: Distribuciones y Servicios Computacionales SA de CV. Calle Juarez 284 local 2 Col. Bugambilias C.P: 83140 Tel: 01-66-22-14-9005 E-Mail: disc2@hmo.megared.net.mx	Villahermosa: Compumantenimientos Garantizados, S.A. de C.V. AV. GREGORIO MENDEZ #1504 COL, FLORIDA C.P. 86040 Tel: 01 (993) 3 52 00 47 / 3522074 / 3 52 20 09 E-Mail: compumantenimientos@prodigy.net.mx
Puebla, Pue. (Matriz): RENTA Y DATOS, S.A. DE C.V. Domicilio: 29 SUR 721 COL. LA PAZ 72160 PUEBLA, PUE. Tel: 01(52).222.891.55.77 CON 10 LINEAS E-Mail: datos@puebla.megared.net.mx	Veracruz, Ver.: CONEXION Y DESARROLLO, S.A DE C.V. Av. Americas # 419 ENTRE PINZÓN Y ALVARADO Fracc. Reforma C.P. 91919 Tel: 01-22-91-00-31-67 E-Mail: gacosta@qplus.com.mx
Chihuahua Soluciones Globales en Computación C. Magisterio # 3321 Col. Magisterial Chihuahua, Chih. Tel: 4136954 E-Mail: Cefeo@soluglobales.com	Cuernavaca Compusupport de Cuernavaca SA de CV Francisco Leyva # 178 Col. Miguel Hidalgo C.P. 62040, Cuernavaca Morelos Tel: 01 777 3180579 / 01 777 3124014 E-Mail: aquevedo@compusupportcva.com
Distrito Federal: QPLUS, S.A. de C.V. Av. Coyoacán 931 Col. Del Valle 03100, México, D.F. Tel: 01(52)55-00-00-27-35 E-Mail : gacosta@qplus.com.mx	Guadalajara, Jal.: SERVICIRECE, S.A. de C.V. Av. Niños Héroes # 2281 Col. Arcos Sur, Sector Juárez 44170, Guadalajara, Jalisco Tel: 01(52)33-36-15-15-43 E-Mail: mmiranda@servirece.com
Guerrero Acapulco GS Computación (Grupo Sesiscomp) Progreso #6-A, Colo Centro 39300 Acapulco, Guerrero Tel: 744-48-32627	Monterrey: Global Product Services Mar Caribe # 1987, Esquina con Golfo Pérsico Fracc. Bernardo Reyes, CP 64280 Monterrey N.L. México Tel: 8129-5103 E-Mail: aydeem@gps1.com.mx
MERIDA: ELECTROSER Av Reforma No. 403Gx39 y 41 Mérida, Yucatán, México CP97000 Tel: (52) 999-925-1916 E-Mail: rrb@sureste.com	Oaxaca, Oax.: CENTRO DE DISTRIBUCION Y SERVICIO, S.A. de C.V. Murguía # 708 P.A., Col. Centro, 68000, Oaxaca Tel: 01(52)95-15-15-22-22 Fax: 01(52)95-15-13-67-00 E-Mail: gpotai2001@hotmail.com
Tijuana: STD Av Ferrocarril Sonora #3780 L-C Col 20 de Noviembre Tijuana, Mexico	FOR USA SUPPORT: ViewSonic Corporation 381 Brea Canyon Road, Walnut, CA. 91789 USA Tel: 800-688-6688 (English); 866-323-8056 (Spanish); Fax: 1-800-685-7276 E-Mail: http://www.viewsonic.com

Projector Mexico Warranty Term Template In UG

VSC_TEMP_2006



ViewSonic®