



USER GUIDE

Speakeasy Combo 3865 Twin
Speakeasy Combo 3865 Triple



Binatone Helpline (for UK only)

Monday to Friday from 9:00am to 5:00pm





Tel: 0845 345 9677

**Please note that all calls are charged at local rate

Or visit our website: www.binatonetelecom.com

THE CORDLESS HANDSET IS NOT DESIGNED FOR MAKING EMERGENCY TELEPHONE CALLS WHEN THE POWER FAILS, BUT IF THERE IS A POWER FAILURE, YOU CAN STILL USE THE BASE AND THE CORDED HANDSET TO MAKE AN EMERGENCY CALL.

Before operating this set,
please read these instructions carefully.







TECHNICAL DETAILS

Standard	Digital Enhanced Cordless Telecommunication (DECT)
Frequency range	1.88 to 1.9 GHz (bandwidth = 20 MHz)
Channel bandwidth	1.728 MHz
Operating range	Up to 300m outdoors; Up to 50m indoors
Operating time	Standby: 100 hours, Talking: 10 hours Battery charge time: 15 hours
Temperature range	Operating 0°C to 40°C, Storage -20°C to 60°C
Electrical power	Corded Base: Ten Pao - S004LB0600045 / S004LV0600045 input 100-240VAC 50/60Hz 150mA, output 6VDC 450mA Charger unit: Ten Pao - S004LB0600030 / S004LV0600030 input 100-240VAC 50/60Hz 150mA, output 6VDC 300mA Battery Information GPI - VT40AAAHC 2 x 1.2V AAA size 400mAh NiMH BYD - H-AAA400A 2 x 1.2V AAA size 400mAh NiMH CORUN - AAAJ400 2 x 1.2V AAA Size 400mAh NiMH

Risk of explosion if the batteries are replaced by an incorrect type
Dispose of used batteries safely at a recycling centre.

Port specification

The  port (connected to the mains power supply) is a SELV port with respect to EN41003.

The  port (connected to the telephone line) is a TNV port with respect to EN41003.

CLEANING AND CARE

Do not clean any part of your phone system with benzene, thinners or other solvent chemicals as this may cause permanent damage which is not covered by the Guarantee.

When necessary, clean it with a damp cloth.

Keep your phone system away from **hot, humid conditions or strong sunlight, and don't let it get wet.**

Every effort has been made to ensure high standards of reliability for your phone system. However, if something does go wrong, please **do not try to repair it yourself, but** consult your supplier or the Helpline.



TABLE OF CONTENTS

1	IMPORTANT SAFETY INSTRUCTIONS	6
2	INSTALLING YOUR PHONE	8
2.1	CONNECTING THE CORDED BASE STATION	8
2.2	INSTALLING THE CORDLESS HANDSET AND CHARGING THE BATTERIES.....	9
3	GETTING TO KNOW YOUR PHONE	10
3.1	OVERVIEW OF THE HANDSET	10
3.2	DISPLAY ICONS AND SYMBOLS	12
3.3	CORDLESS HANDSET MENU STRUCTURE.....	13
3.4	CORDED BASE STATION.....	14
3.5	LCD DISPLAY	16
3.6	BASE MENU STRUCTURE	17
3.7	TEXT AND DIGIT ENTRY	18
	<u>Using a cordless handset:</u>	
3.7.1	ENGLISH CHARACTER SET	18
3.7.2	RUSSIAN CHARACTER SET	19
	<u>Using the corded base:</u>	
3.7.3	CHARACTER TABLE.....	19
4	USING YOUR PHONE	20
	<u>Using a cordless handset:</u>	
4.1	MAKE A CALL	20
4.1.1	PREPARATORY DIALLING	20
4.1.2	DIRECT DIALLING	20
4.1.3	CALL FROM THE CONTACTS LIST	20
4.1.4	CALL FROM THE CALL LOG.....	20
4.1.5	CALL FROM THE REDIAL LIST.....	20
4.1.6	CALL TIMER	20
4.2	MAKE A CALL FROM DIRECT MEMORY KEYS (M1-M3).....	21
4.3	ANSWER A CALL	21
4.4	AUDIO BOOST FEATURE	21
4.5	END A CALL	21
4.6	ADJUST EARPIECE AND HANDSFREE VOLUME	21
4.7	MUTE A CALL.....	22
4.8	TURN OFF THE HANDSET RINGER	22
4.9	TURN ON THE KEYPAD LOCK	22
4.10	REDIAL THE LAST NUMBER	22
4.10.1	REDIAL A NUMBER FROM THE REDIAL LIST	22
4.10.2	STORE A REDIAL NUMBER INTO THE CONTACTS LIST	22

4.10.3	DELETE A REDIAL NUMBER	23
4.10.4	DELETE ALL REDIAL LIST ENTRIES	23

Using the corded base:

4.11	MAKE AN EXTERNAL CALL	23
4.11.1	PREPARATORY DIALLING	23
4.11.2	DIRECT DIALLING	23
4.11.3	CALL FROM THE PHONEBOOK	23
4.11.4	CALL FROM THE CALL LOG	24
4.11.5	CALL FROM THE REDIAL LIST	24
4.11.6	CALL TIMER	24
4.12	ANSWER A CALL	24
4.13	END A CALL	24
4.14	ADJUST EARPIECE AND HANDSFREE VOLUME	24
4.15	AUDIO BOOST FEATURE	24
4.16	MUTE A CALL	25
4.17	MEMORY KEYS	25
4.17.1	STORE A NUMBER INTO A MEMORY KEY	25
4.17.2	DIAL THE NUMBER IN A MEMORY KEY	25
4.18	EMERGENCY CALL WITHOUT MAINS POWER	25
4.19	REDIAL	26
4.19.1	REDIAL A NUMBER FROM THE REDIAL LIST	26
4.19.2	SAVE A REDIAL NUMBER INTO THE PHONEBOOK	26
4.19.3	DELETE A REDIAL NUMBER	26
4.19.4	DELETE ALL REDIAL LIST ENTRIES	26
4.20	FIND THE CORDLESS HANDSET	26
4.21	MAKE AN INTERNAL CALL	27
4.21.1	INTERCOM	27
4.21.2	CALL ALL HANDSETS	27
4.21.3	TRANSFER AN EXTERNAL CALL	28
4.21.4	MAKE A 3-WAY CONFERENCE CALL	29

5 PRIVATE PHONEBOOK **30**

Using a cordless handset:

5.1	ADD A NEW PHONEBOOK ENTRY	30
5.2	SEARCH FOR A PHONEBOOK ENTRY	30
5.3	VIEW A PHONEBOOK ENTRY	30
5.4	EDIT A PHONEBOOK ENTRY	31
5.5	DELETE A PHONEBOOK ENTRY	31
5.6	DELETE ALL PHONEBOOK ENTRIES	31
5.7	CHECK THE PHONEBOOK USAGE	31
5.8	SET THE FAST DIAL NUMBERS	32
5.8.1	ADD OR EDIT A FAST DIAL NUMBER	32
5.8.2	DELETE A FAST DIAL NUMBER	32

Using the corded base:

5.9	ADD A NEW ENTRY	32
5.10	EDIT AN ENTRY	33
5.11	VIEW AN ENTRY	33
5.12	DELETE AN ENTRY	34
5.13	DELETE ALL PHONEBOOK ENTRIES	34
5.14	VIEW PHONEBOOK CAPACITY	34

6 CALLER DISPLAY (NETWORK DEPENDENT) **35**

Using a cordless handset:

6.1	VIEW THE CALL LOG	35
6.2	STORE A CALL LOG NUMBER INTO THE CONTACTS	36
6.3	DELETE AN ENTRY IN THE CALL LOG	36
6.4	DELETE ALL CALL LOG ENTRIES	36
6.5	CALL LOG CATEGORY	36

Using the corded base:

6.6	VIEW THE CALL LOG	37
6.7	STORE A CALL LOG NUMBER INTO THE PHONEBOOK	37
6.8	DELETE AN ENTRY IN THE CALL LOG	37
6.9	DELETE ALL CALL LOG ENTRIES	37

7 PHONE SETTINGS **38**

Using a cordless handset:

7.1	CLOCK SETTINGS	38
7.1.1	CHANGE THE DATE FORMAT	38
7.1.2	CHANGE THE TIME FORMAT	38
7.1.3	SET THE TIME	38
7.1.4	SET THE DATE	38
7.2	ALARM SETTINGS	39
7.2.1	TURN ON/OFF THE ALARM	39
7.2.2	SET THE ALARM TIME	39
7.3	HANDSET SETTINGS	40
7.3.1	RINGER SETUP	40
7.3.2	SET ALERT TONES	40
7.3.3	SET THE EQUALIZER	41
7.3.4	SELECT BASE	41
7.3.5	SET THE HANDSET LANGUAGE	41
7.3.6	RENAME THE HANDSET	41
7.3.7	CHOOSE THE INFORMATION TO BE DISPLAYED IN IDLE	42
7.3.8	SET THE AUTO ANSWER	42
7.3.9	SET THE DIRECT MEMORY KEYS	42
7.3.10	SET THE MAILBOX NUMBER	42

7.4	BASE SETTINGS	43
7.4.1	DE-REGISTER A HANDSET	43
7.4.2	CHANGE THE DIAL MODE	43
7.4.3	CHANGE THE RECALL (FLASH) TIME	44
7.4.4	CHANGE THE SYSTEM PIN CODE	44
7.4.5	RESET YOUR CORDLESS PHONE	44

Using the corded base:

7.5	SET DATE AND TIME	45
7.6	DE-REGISTER A HANDSET	45
7.7	RINGER SETUP	46
7.7.1	CHANGE RINGER MELODY	46
7.7.2	CHANGE RINGER VOLUME	46
7.8	SET THE DIAL MODE	46
7.9	SET THE RECALL (FLASH) TIME	47
7.10	SET THE KEY TONE	47
7.11	SET THE LANGUAGE	47
7.12	CHANGE THE SYSTEM PIN	47
7.13	BASE DEFAULT	48

8 REGISTRATION **49**

9 ANSWERING MACHINE (TAM) **50**

Using a cordless handset:

9.1	TURN ON/OFF THE ANSWERING MACHINE	50
9.2	LISTEN TO THE MESSAGES IN THE ANSWERING MACHINE	51
9.3	DELETE ALL MESSAGES IN THE ANSWERING MACHINE	52
9.4	RECORD MEMO	52
9.5	ANSWERING MACHINE SETTINGS	52
9.5.1	SET THE ANSWER MODE	52
9.5.2	SET THE OUTGOING MESSAGE LANGUAGE	53
9.5.3	RECORD YOUR OWN OUTGOING MESSAGE (OGM)	53
9.5.4	PLAYBACK AND DELETE THE OUTGOING MESSAGE	54
9.5.5	SET THE ANSWER DELAY	54
9.5.6	SET THE MAXIMUM RECORDING TIME FOR INCOMING MESSAGES	55
9.5.7	CHANGE THE COMPRESSION RATE	55
9.5.8	REMOTE ACCESS	55
9.5.9	CALL SCREENING	57

TABLE OF CONTENTS

Using the corded base:

9.6 SWITCHING THE TAM ON/OFF	58
9.6.1 USING THE DIRECT KEY.....	58
9.6.2 USING THE MENU.....	58
9.7 OGM SETTINGS	58
9.7.1 RECORD YOUR OUTGOING MESSAGE (OGM).....	58
9.7.2 PLAYBACK THE OUTGOING MESSAGE (OGM).....	59
9.7.3 DELETE A PERSONAL OGM (SET OGM TO DEFAULT).....	59
9.8 SWITCH BETWEEN OGMs	60
9.9 TAM MESSAGES	60
9.9.1 PLAY THE TAM MESSAGES.....	60
9.9.2 DELETE A MESSAGE ON THE TAM.....	61
9.9.3 DELETE ALL MESSAGES ON THE TAM.....	61
9.10 RECORD A MEMO ON THE TAM	62
9.10.1 USING THE DIRECT KEY.....	62
9.10.2 USING THE MENU.....	62
9.11 INCOMING CALL MESSAGES (ICM)	62
9.12 TAM SETTINGS	63
9.12.1 SET THE ANSWER DELAY.....	63
9.12.2 SET THE MAXIMUM RECORDING TIME FOR INCOMING MESSAGES.....	63
9.12.3 SET THE OUTGOING MESSAGE LANGUAGE.....	64
9.12.4 TURN ON OR OFF THE BASE SCREENING.....	64
9.12.5 ACTIVATE REMOTE ACCESS.....	64
9.12.6 CHANGE THE COMPRESSION RATE.....	65
9.12.7 CHANGE THE 4-DIGIT REMOTE ACCESS PIN.....	65
<u>REMOTE CARD</u>	65
9.12.8 RESET THE TAM TO DEFAULT SETTINGS.....	66
<u>10 TROUBLESHOOTING</u>	67
<u>11 DECLARATION OF CONFORMITY</u>	68
<u>12 PRODUCT GUARANTEE</u>	69





1 IMPORTANT SAFETY INSTRUCTIONS

When using your telephone equipment, basic safety precautions should always be followed to reduce the risk of fire, electric shock and injury, including the following:

- 1) Read and understand all the instructions.
- 2) Follow all warnings and instructions marked on the product.
- 3) Unplug this product from the wall outlet before cleaning. Do not use liquid cleaners or aerosol cleaners. Use a damp cloth for cleaning.
- 4) Keep this product away from hot, humid conditions or strong sunlight, and don't let it get wet or use it near water (for example, near a bath tub, shower, kitchen sink, swimming pool).
- 5) Do not overload wall outlets and extension cords as this can result in the risk of fire or electric shock.
- 6) Unplug this product from the wall outlet and refer servicing to our Repair Centre under the following conditions:
 - When the power supply cord or plug is damaged or frayed.
 - If the product does not operate normally by following the operating instructions.
 - If the product has been dropped and the cabinet has been damaged.
 - If the product exhibits a distinct change in performance.
- 7) NEVER use this product outdoors during a thunderstorm. Unplug the base from the telephone line and the mains socket when there are storms in your area. Damage caused by lightning is not covered by the guarantee.
- 8) Do not use the telephone to report a gas leak in the vicinity of the leak.
- 9) Use only the supplied NiMH (Nickel Metal Hydride) batteries! The operation periods for the handsets are only applicable with the default battery capacities.
- 10) The use of other battery types or non-rechargeable batteries/primary cells can be dangerous. These may cause interference and/or damage to the unit or surroundings. The manufacturer will not be held liable for damage arising from such non-compliance.
- 11) Do not use third party charging bays.
Damage may be caused to the batteries.
- 12) Make sure the batteries are fitted into the handset in the correct polarity.
- 13) Dispose of batteries safely. Do not immerse them in water, burn them, or put them where they could get punctured.



Package contents

The package contains the following items:

- 1 Corded Handset
- 1 Coiled Cord
- 1 Base station
- 1 Cordless Handset
- 1 Charger Pod with connected AC power adapter
- 1 AC power adapter for the base station
- 1 Telephone line cord
- 2 Rechargeable Batteries
- 1 User manual

NOTE: If you have a Twin, Triple or Quad system, you will also have the requisite extra cordless handsets, batteries and charger pods.

Radio signals between the cordless handset and the base unit:

To use your cordless handset and base together, you must be able to establish a radio link between them. The signal between the handset and base is in accordance with the normal standards for a DECT phone: maximum range up to 300 metres outdoors or 50 metres indoors.□□

The signal range may decrease if there is any large metal object between the handset and the base, such as a refrigerator, a mirror, a filing cabinet, metallic doors or reinforced concrete. The signal strength may also be reduced by other solid structures like walls, or by other radio or electrical interference.



2 INSTALLING YOUR PHONE

2.1 Connecting the corded base station

- ① Use the coiled cord to connect the corded handset to the base station, making sure the plugs are inserted fully into the sockets on the handset and on the side of the base, until they click in place.
- ② Plug the power supply cord & phone line cord into the sockets in the underside of the base station.
- ③ Plug the power adapter into a 230Vac, 50Hz mains socket, and the line cord into your telephone line socket.

Warning: Use only the power adapter provided for the base station.

Warning: Always use the cables provided in the box, others may not be compatible.

Note: The base unit needs mains power for normal operation, and the cordless handset will not work without it. (If the mains power fails, calls can still be made or received using the corded handset.)

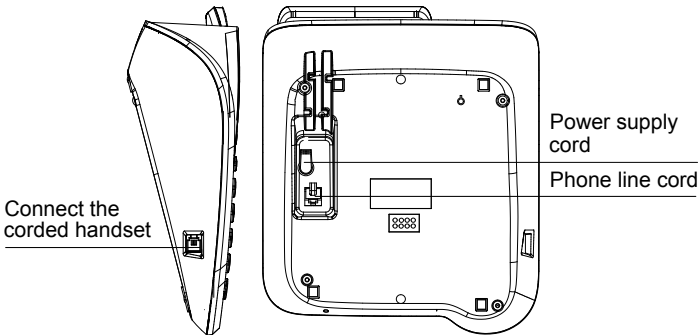

If you have a Broadband line (ADSL)

If you connect your telephone to a line with a broadband (ADSL) connection, you will need to insert a micro-filter between the telephone and the telephone line, otherwise you may get interference between the telephone and the broadband, which could cause problems.

In a home with broadband, every telephone must have a micro-filter connected, not just the one at the telephone point that your modem is connected to.

If you need more broadband (ADSL) micro-filters, contact your broadband supplier.

2.2 Installing the cordless handset and charging the batteries

- 1) Slide open the battery compartment cover from the back of the handset.
- 2) Place the 2 supplied batteries into the battery compartment with the polarity markings as indicated.
- 3) Slide the battery compartment cover back until it clicks into place.
- 4) Put the cordless handset on the charger and charge for 15 hours before using the handset for the first time. The handset will give a beep when it is properly placed on the charger.

Use only NiMH rechargeable batteries.

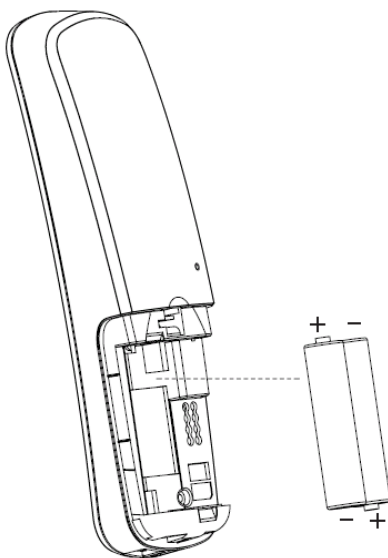

3 GETTING TO KNOW YOUR PHONE

3.1 Overview of the Handset

① ▲ VOL+ / VOL- ▼ (Buttons on handset side)

During a call: Press to increase or decrease the earpiece or loudspeaker volume.

② M1/M2/M3 - DIRECT MEMORY KEYS

In idle mode: Press and hold to dial the stored number.

③ CLEAR/BACK/MUTE (C/Mute)

In main menu mode: Press to go back to idle screen.

In sub-menu mode: Press to go back to previous level.

In sub-menu mode: Press and hold to go back to idle screen.

In editing / predialling mode: Press to clear a character / digit.

In editing / predialling mode: Press and hold to delete all the characters / digits.

During a call: Press to mute / unmute the microphone.

In idle mode: Press to intercom another handset.

④ UP/CALL LOG (▲ Calls)

In idle mode: Press to access the call log.

In menu mode: Press to scroll up the menu items.

In Contacts list / Redial list / Call Log: Press to scroll up the list.

⑤ DOWN/REDIAL LIST (▼ Redial)

In idle mode: Press to access the redial list.

In menu mode: Press to scroll down the menu items.

In Contacts list / Redial list / Call Log: Press to scroll down the list.

⑥ TALK OFF (Off)

During a call: Press to end a call and go back to idle mode.

In menu / editing mode: Press to go back to previous menu.

In menu / editing mode: Press and hold to go back to idle screen.

In idle mode: Press and hold to power off the handset.

In idle mode (when the handset is powered off): Press and hold to power on the handset.

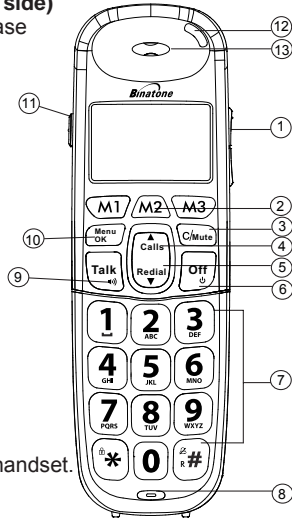

⑦ **ALPHANUMERIC KEYPAD, * (STAR), # (HASH)**

Press to insert a digit / character / * / #

1-9 keys in idle mode: Press and hold to dial out pre-stored fast - key memories.

* key in idle mode: Press and hold to enable or disable the keypad lock.

* key during a call (in Pulse mode): Press to switch to tone mode.

key during a call: Press and hold to insert a recall (R) signal (also called flash).

key in Idle mode: Press and hold to turn on / off the handset ringer.

0 key in idle / predialling / number editing mode: Press and hold to insert a pause.

key in the Call Log: Press to review caller's number if applicable.

⑧ **MICROPHONE**

⑨ **TALK ON/SPEAKERPHONE (Talk )**

In idle / predialing mode : Press to make a call.

In Redial list / Call Log / Contacts list: Press to make a call to the selected entry in the list.

During ringing: Press to answer a call.

During a call: Press to switch between Speakerphone and Earpiece.

⑩ **MENU/OK ( Menu )**

In idle mode: Press to access the main menu.

In sub-menu mode: Press to confirm the selection.

During a call: Press to access Intercom/ Contacts/ Redial List/ Call Log

⑪ **AMPLIFY () (Button on handset side)**

During a call: Press to turn on or off the audio boost.

⑫ **LED**

Steadily on when audio boost is turned on.

Flashes when there is an incoming call.

⑬ **EARPIECE**



3.2 Display Icons and Symbols

The screen display gives you information on the current status of the telephone.

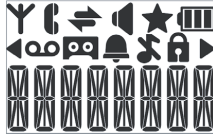

Steady on when the handset is within range of the base.
Flashes when the handset is out of range of the base or cannot communicate with the base.



Steady on when a call is in progress.
Flashes when there is an incoming call.



On when the speakerphone is turned on.



Steady on when an intercom call is in progress.



Flashes during intercom ringing.

Steady on when the telephone answering machine (TAM) is turned on. Flashes when a new TAM message is recorded.



On when a new TAM message is playing or a new call is viewed in the Call Log.



On when the handset ringer is switched off.



Steady on when an alarm is set.

Flashes when the alarm time has been reached.



On when the keypad is locked.



On when you have a new Voice Mail message. (This is a caller display service and is not usually available from UK network providers.)



Indicates when there are more characters or numbers in front of those being displayed.



Indicates when there are more characters or numbers after those being displayed.



Full battery power level.



2/3 battery power level.



1/3 battery power level.



Flashes when low battery power level is detected, needs charging.



Cycles when the battery is charging.



3.3 Cordless Handset Menu Structure

In idle mode, press <MENU/OK> to go to CONTACTS, the first option in the menu list. Refer to the following for the menu structure.

Press <UP> or <DOWN> to go to other options in the menu list.

Press <MENU/OK> to enter a sub-menu or function.

Press <C/MUTE> to go back to the previous level.

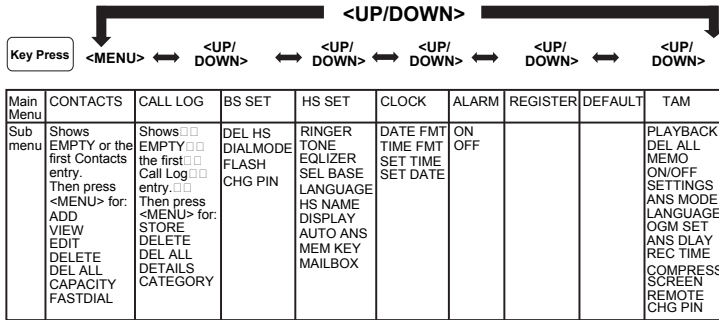

The following keys have direct functions in idle mode:

Keys	Redial ▼	▲ Calls	C/Mute
	Shows EMPTY or the first Redial List entry.	Shows EMPTY or the first Call Log entry.	Shows the available intercom numbers, or starts the intercom ringing to the base if there are no other handsets registered.
Sub menu (Press MENU/OK if the list is not empty)	STORE DELETE DEL ALL	STORE DELETE DEL ALL DETAILS CATEGORY	

3.4 Corded Base Station

① LCD DISPLAY

Tilt the display to meet your best viewing angle.

② UP (▲+)

In menu mode: Press to scroll up the menu items

In Phonebook list / Redial list / Call Log: Press to scroll up the list

During a call or TAM message playback: Press to increase the volume

③ PHONEBOOK (☐)

In Idle: Press to access phonebook list

In editing mode: Press to move the cursor one character to the left

④ MENU/OK (Menu/OK)

In idle mode: Press to access the main menu

In sub-menu mode: Press to confirm the selection

In Redial List / Call Log: Press for sub-menu.

⑤ REPEAT (REPEAT)

In Idle mode: Press and hold to record OGM
Press to playback OGM

In TAM message playback mode: Press once to repeat the current message, or twice to go back to the previous message

⑥ PLAY / STOP (PLAY/STOP)

In idle mode: Press to playback messages

During TAM message playback: Press to stop playing messages

⑦ MEMORY KEYS (M1-M5)

In predial mode: Press and hold to store the number on the display.

In idle mode: Press to dial out the number stored in the memory key.

⑧ DIGIT KEYPAD (0-9, *, #)

In predial or editing mode: Press to enter a digit or character.

In predial or editing mode: Press and hold "0" to insert a pause.

⑨ ANS ON / OFF (Answer ON/OFF)



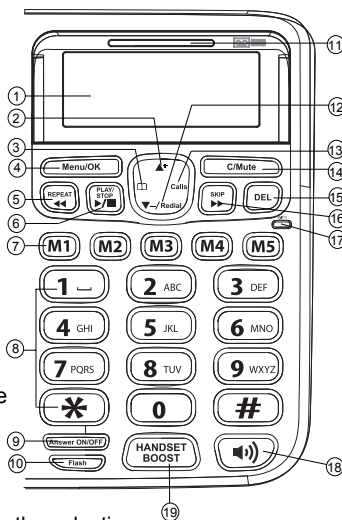

In Idle: Press to switch the answering machine ON or OFF.

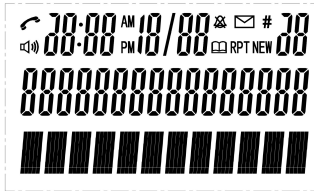

- ⑩ **RECALL (FLASH)**
In predial mode or during a call: Press to insert a Recall (Flash) signal.
- ⑪ **RINGER Indication**
Flashes when ringing.
- ⑫ **▼ — / Redial (DOWN)**
In idle mode: Press to access the Redial List.
In menu mode: Press to scroll down the menu items.
In Phonebook list / Redial list / Call Log: Press to scroll down the list.
During a call or TAM message playback: Press to decrease the volume.
- ⑬ **CALLS (Calls)**
In Idle mode: Press to access the Call Log.
In editing mode: Press to move the cursor one character to the right.
- ⑭ **CLEAR/MUTE (C/Mute)**
In main menu mode: Press to go back to idle screen
In sub-menu mode: Press to go back to previous level
In editing / predialling mode: Press to clear a character / digit
During a call: Press to mute / unmute the microphone
During ringing: Press to silence.
In idle mode: Press to intercom handsets.
- ⑮ **DELETE (DEL)**
In TAM message playback mode: Press to delete the message playing.
In idle mode: Press and hold to delete all old TAM messages.
- ⑯ **FORWARD/MEMO (SKIP)**
In idle mode: Press and hold to record a Memo.
In TAM message playback mode: Press to skip forward to play the next message.
- ⑰ **TAM ON/OFF Indication**
On steady when the answering machine is turned on and there are no new messages.
Slowly flashes when there is a new message.
Quickly flashes when there is an incoming call.
- ⑱ **SPEAKERPHONE (☎)**
In Idle mode or Phonebook/ Call Log/ Redial list view mode:
Press to make a call with speakerphone.
- ⑲ **HANDSET BOOST**
During a call: Press to activate/deactivate the handset amplifier boost function.

3.5 LCD Display



Icons	Description
	Indicates a call is in progress.
	Indicates that handsfree is being used.
AM PM	Indicates the time of day.
	Indicates that the base ringer volume is switched off.
	This will display when you are in the phonebook menu.
	Indicates when you have a new Voice Mail message. (This is a caller display service and is not usually available from UK network providers.)
RPT	This will display when the same caller has called more than once
#	Indicates the sequence number of the CID record
NEW	This will display when there is a new CID entry or if one is being viewed.

3.6 Base Menu Structure

In idle mode, press <MENU/OK> to go to PHONE BOOK, the first option in the menu list.

Press <UP> or <DOWN> to go to other options in the menu list.

Press <MENU/OK> to enter a sub-menu or function.

Press <C/MUTE> to go back to the previous level.

Refer to the following for the menu structure.

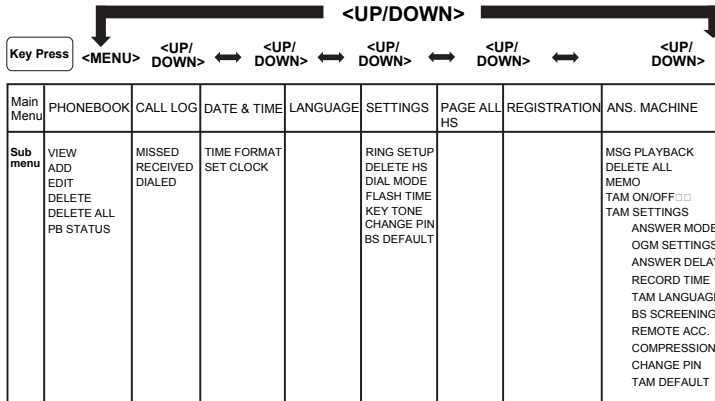

The following keys have direct functions in idle mode:

Keys	▼ / Redial	Calls	CLEAR/MUTE
	Shows EMPTY or the first Redial List entry.	Shows EMPTY or the first Call Log entry.	Shows the available intercom numbers.
Sub menu (Press MENU/OK if the list is not empty)	ADD TO PB? DELETE? DELETE ALL?	ADD TO PB? DELETE? DELETE ALL?	

3.7 Text and Digit Entry

The following tables show you where each letter and punctuation character can be found, by using repeated presses of the alphanumeric keypads.

This will be helpful when storing a name in handset or base phonebook or renaming your handset.

In editing mode, a cursor is displayed to indicate the current text entry position. It is positioned at the right of the last character entered.

Writing Tips:

1. Once a character is selected, the cursor will move to the next position after a short pause.
2. You can move the cursor within the text with the <UP/DOWN> keys on the handset or with the <PHONEBOOK/CALLS> keys on the base, to amend the text entry.
3. Press <C/MUTE> to delete the last character.
4. Press and hold <C/MUTE> to delete the entire text string.

Using a cordless handset:

3.7.1 English Character Set

Key press	Alphanumeric Editing (For phonebook name editing and renaming handset)										Number Editing (For phone number editing, date/time editing)	
	1st	2 nd	3rd	4th	5th	6th	7th	8th	9th	10th		
1	space	-	1									1
2	A	B	C	2								2
3	D	E	F	3								3
4	G	H	I	4								4
5	J	K	L	5								5
6	M	N	O	6								6
7	P	Q	R	S	7							7
8	T	U	V	8								8
9	W	X	Y	Z	9							9
0	0											0, P (Pause)
*	*	?	/	\	()						*
#	#	'	,	-	.	&						#

3.7.2 Russian Character Set

Key press	Alphanumeric Editing (For phonebook name editing and renaming handset)										Number Editing (For phone number editing, date/time editing)
	1st	2 nd	3rd	4th	5th	6th	7th	8th	9th	10th	
1	SP	-	1								1
2	A	Б	В	Г	2						2
3	Д	Е	Ж	З	3						3
4	И	Й	К	Л	4						4
5	М	Н	О	П	5						5
6	Р	С	Т	У	6						6
7	Ф	Х	Ц	Ч	7						7
8	Ш	Щ	Ъ	Ы	8						8
9	Ь	Э	Ю	Я	9						9
0	0										0, P (Pause)
*	*	?	/	\	()					*
#	#	'	,	-	.	&					#

Using the corded base:

3.7.3 Character Table

0	0																	
1	SP	-	1															
2	A	B	C	2	À	Á	Â	Ã	Ä	Å	Æ	Ç	Ć	Č				
3	D	E	F	3	Ď	È	É	Ê	Ë	Ě	Ě	Ë						
4	G	H	I	4	Ĝ	Ĭ	Í	Ĵ	Ï	Ī	Ī							
5	J	K	L	5	Ł	Ł	Ł											
6	M	N	O	6	Ń	Ń	Ń	Ô	Ó	Ô	Õ	Ö	Ó	Ø				
7	P	Q	R	S	7	Ř	Ř	Š	Š	Š	ß							
8	T	U	V	8	Ť	Û	Û	Û	Û	Û	Û							
9	W	X	Y	Z	9	Ŵ	Ŷ	Ŷ	Ž	Ž	Ž							
*	*	?	/	\	()												
#	#	'	,	-	.	&												

4 USING YOUR PHONE

Using a cordless handset:

4.1 Make a Call

4.1.1 Preparatory Dialling

Enter the phone number and press <TALK> to dial the number, press it again to turn on the speakerphone. When entering the number, if you make a mistake, press <C/MUTE> to delete digits.

4.1.2 Direct Dialling

Press <TALK> to connect to the line and then enter the phone number. (Note: if you enter a wrong digit you cannot correct it with the <C/MUTE> key.) Press <TALK> again to turn on the speakerphone.

4.1.3 Call from the Contacts List

Press <MENU/OK> twice to access the contacts list and press <UP/DOWN> to select the desired phonebook entry.

Press <TALK> to dial out to the selected entry.

Press it again to turn on the speakerphone.

4.1.4 Call from the Call Log

Press <UP/CALLS> to access the call log and press <UP/DOWN> to select the desired call log entry. Press <TALK> to dial out to the selected call log entry.

Press it again to turn on the speakerphone.

Alternatively, press <MENU/OK> and <UP/DOWN> to access the call log from the main menu.

4.1.5 Call from the Redial List

Press <DOWN/REDIAL> to access the redial list and press <UP/DOWN> to select the desired redial number.

Press <TALK> to dial out to the selected redial number.

Press it again to turn on the speakerphone.

4.1.6 Call timer

Your handset automatically times the duration of every call. The call time is displayed as soon as you answer a call or 15 seconds after dialling and remains on the screen for 5 seconds after the end of a call.

It is shown in hours, minutes and seconds format (HH:MM:SS).



4.2 Make a call from direct memory keys (M1-M3)

A direct memory key, M1, M2 or M3 must be programmed with a number before it can be used. Please see section 7.3.9 for details.

In idle, press and hold <M1>/<M2>/<M3> to dial the number pre-stored under the respective key.

OR

Press <TALK>, and then press and hold <M1>/<M2>/<M3> to dial the number pre-stored under the respective key.

- If no number is stored, you will hear a double beep tone.

4.3 Answer a Call

If the handset is not on a charging cradle:

When the phone rings, press <TALK> to answer the call, press it again to turn on the speakerphone.

If the handset is on a charging cradle and if AUTO ANS is set to ON: when the phone rings, pick up the handset to answer the call automatically, without having to press any button.

4.4 Audio Boost Feature

The audio boost feature allows you to amplify the handset earpiece volume during a call. (Note: you can also adjust the earpiece frequency response if you have difficulty hearing callers. See section 7.3.3.)

1. To turn on the audio boost feature, press <AMPLIFY> on the right side of the handset, at any time during a call. The handset top indicator turns on and the display shows BOOST ON.

2. When the audio boost is activated, press <VOL+ / VOL-> on the other side of the handset to adjust the earpiece volume further.

3. To turn off the audio boost and return the earpiece volume to normal, press <AMPLIFY> again and the handset top indicator light turns off.

The audio boost turns off automatically when the call is ended.

4.5 End a Call

During a call connection, press <TALK OFF> to end the call.

OR

Put the handset on a charging cradle to end the call.

4.6 Adjust Earpiece and Handsfree Volume

There are 5 levels (VOLUME 1 to VOLUME 5) to choose from for each of the earpiece and handsfree volumes.

During a call, press <VOL+ / VOL-> or <UP/DOWN> to select volume 1-5.

The current setting is shown.

When you end the call, the setting will remain at the last selected level.





4.7 Mute a Call

You can talk to someone nearby without letting the caller hear you during a call. During a call:

Press < C/MUTE > to mute the microphone and "MUTED" will display on the screen.

Your caller cannot hear you.

Press < C/MUTE > again to unmute the microphone.

4.8 To Turn the Handset Ringer Off

In idle mode, press and hold the <#> key to turn off the handset ringer. The ringer off icon  will be displayed.

When the ringer is off, press and hold the <#> key to turn on the handset ringer. The ringer off icon  will turn off.

4.9 Turn on the Keypad Lock

In idle mode, press and hold the <*> key to turn on the keypad lock. The keypad lock icon " " will be displayed.□□

Note: You can still use the <TALK> key to answer a call when the handset is ringing.

In keypad lock mode, press and hold the <*> key to turn off the keypad lock. The keypad lock icon " " will turn off.

4.10 Redial the last number

You can redial any of the 10 last numbers called. If you have stored a name in the phonebook to go with the number, a name will be displayed instead. The most recent last number will display at the top of the redial list.

4.10.1 Redial a Number from the Redial List

1. In idle mode, press <DOWN> to access the redial list.

Note: If the redial entry shows a name, press the <#> key to view the number.

2. Press <UP/DOWN> to browse the redial list.

3. Press <TALK> to dial the selected redial number.

Note: If there are no numbers in the redial list, the display shows "EMPTY".

4.10.2 Store a Redial Number into your Contacts list

1. Follow Steps 1 and 2 in section 4.10.1.





2. Press <MENU/OK> and <UP/DOWN> to select STORE.

3. Press <MENU/OK> and then enter the name you want to use in your Contacts list.

4. Press <MENU/OK> and then modify the number, if necessary.

5. Press <MENU/OK> to show RING 1.



- 
- 
- 
- 
6. Press <UP/DOWN> to browse the ring tone list. The respective ring tone will be played when browsing the ring tone list. (Note: the selected ring tone will only play when you receive a call if you subscribe to Caller Display and the incoming number matches the stored number.)
 7. Press <MENU/OK> to confirm the selected ring tone and to save the entry.

4.10.3 Delete a Redial Number

1. Follow Steps 1 and 2 in section 4.10.1.
2. Press <MENU/OK> and <UP/DOWN> to select DELETE.
3. Press <MENU/OK> to confirm and the entry will be deleted.

4.10.4 Delete all Redial List entries

1. Follow Steps 1 and 2 in section 4.10.1.
2. Press <MENU/OK> and <UP/DOWN> to select DEL ALL.
3. Press <MENU/OK> to display CONFIRM?
4. Press <MENU/OK> again to confirm.
All entries will be deleted and the display will show EMPTY.

Using the corded base:

4.11 Make an External Call

4.11.1 Preparatory dialling

Enter the phone number and lift up the corded handset or press <SPEAKERPHONE> to dial the number. When entering the number, if you make a mistake, press <C/MUTE> to delete digits.

Note: To insert a pause in the dialling sequence, press and hold the < 0 > button, the screen will then show a "P" in the number.
Press <FLASH> to insert a recall (flash) signal and the screen will show a "F".

4.11.2 Direct dialling

Lift up the corded handset or press <SPEAKERPHONE> to connect to the line and then enter the phone number. (Note: if you enter a wrong digit you cannot correct it with the <C/MUTE> key.)

4.11.3 Call from the phonebook

Press <PHONEBOOK> to access the phonebook and press <UP/DOWN> to select the desired phonebook entry.

Lift up the corded handset or press <SPEAKERPHONE> to dial out the selected phonebook entry.

4.11.4 Call from the call log

Press <CALLS> to access the Call Log and press <UP/DOWN> to select the desired Call Log entry. Lift up the corded handset or press <SPEAKERPHONE> to dial out the selected Call Log entry.

4.11.5 Call from the redial list

Press <DOWN / REDIAL> to access the redial list and press <UP/DOWN> to select the desired redial number. Lift up the handset or press <SPEAKERPHONE> to dial out the selected redial number.

4.11.6 Call timer

Your base display automatically times the duration of every call. The call timer appears on the display as soon as a call is answered or about 15 seconds after dialling, and remains on the screen for a few seconds after the end of the call. It is shown in hours, minutes and seconds format (HH:MM:SS).

4.12 Answer a Call

When there is an incoming ring, pick up the handset or press <SPEAKERPHONE> to answer the call.

4.13 End a Call

During a call connection, put the corded handset on the base station to end the call.

Or press <SPEAKERPHONE> if you have a call in handsfree mode.

4.14 Adjust Earpiece and Handsfree Volume

There are 5 levels (VOLUME 1 to VOLUME 5) to choose from for each of the earpiece and speaker volumes.

During a call:

Press <UP/DOWN> to increase or decrease the volume level respectively.

The current setting is shown. When you end the call, the settings will remain at the last selected level.

4.15 Audio Boost feature

During a call, you can activate the audio boost feature to increase the earpiece volume of the corded handset by pressing <HANDSET BOOST>, "BOOSTER ON" displays on the screen. To cancel it, press <HANDSET BOOST> again, and the screen displays "BOOSTER OFF" for around 2 seconds before going back to the normal call mode.

The audio boost feature will be turned off automatically when the call is ended or if it is switched to handsfree mode.



4.16 Mute a Call

You can talk to someone nearby without letting the caller hear you during a call.

During a call:

Press <C/MUTE> to mute the microphone and **“MUTED”** is displayed on the display. Your caller cannot hear you. Press <C/MUTE> again to unmute the microphone. **“MUTED”** will be replaced by **“LINE IN USE”** on the display, and the caller will be able to hear you again.

4.17 Memory Keys

There are 5 memory keys (from M1 to M5) on the corded base for you to store frequent use numbers. After a number is stored in a memory key, you can simply press the memory key once to dial out the number automatically in speakerphone mode.

4.17.1 Store a number into a memory key

1. In idle mode, enter the telephone number you want to store.
2. Press and hold the memory key you want to use for more than 2 seconds, until you hear the confirmation tone to indicate the number has been stored.

Note: If there is already a number stored it will be replaced by the new number.

4.17.2 Dial the number in a memory key

In idle mode, press <M1>/ <M2>/ <M3>/ <M4>/ <M5>, the phone will automatically dial out the telephone number stored under the selected memory key in speakerphone mode.

4.18 Emergency Call without Mains Power

The corded base unit can make an emergency call with the corded handset when the mains AC power is disconnected.

Pick up the corded handset and wait for several seconds to get the dial tone and then enter the phone number to make a call.

Note: It is not possible to dial numbers from memories or use the speakerphone when the mains power is off.

When the mains power is off, you can also answer an incoming call with the corded handset.

When the phone rings, pick up the corded handset to talk to the caller after a few seconds.





4.19 Redial

You can redial any of the last 10 numbers called. If you have stored a name in the phonebook to go with the number, the name will be displayed as well.

4.19.1 Redial a Number from the Redial List

1. In idle mode, press <DOWN / REDIAL> to view the redial list.

Note: the redial list can also be viewed using <MENU> then selecting CALL LOG and DIALED.

2. Press <UP/DOWN> to browse the redial list.

3. Pick up the corded handset or press <SPEAKERPHONE> to dial the selected redial number.

Note: If no numbers are in the redial list, the display will show *"EMPTY"*.

4.19.2 Save a Redial Number into the Phonebook

1. Follow steps 1 and 2 in section 4.19.1.

2. Press <MENU/OK> to show **ADD TO PB?**

3. Press <MENU/OK> and then enter the name for the phonebook entry.

4. Press <MENU/OK> and then modify the number, if necessary.

5. Press <MENU/OK> and then <UP/DOWN> to select a melody.

Note: The selected melody will only play when you receive a call if you subscribe to Caller Display and the incoming number matches the stored number.

6. Press <MENU/OK> to save the redial number into the phonebook.

4.19.3 Delete a Redial Number

1. Follow steps 1 and 2 in section 4.19.1.

2. Press <MENU/OK> and <UP/DOWN> to select **DELETE?**

3. Press <MENU/OK> to show CONFIRM?

4. Press <MENU/OK> to confirm the delete.

4.19.4 Delete All Redial List Entries

1. In idle mode, press <DOWN / REDIAL> to open the redial list.

2. Press <MENU/OK> and <UP/DOWN> to select **DELETE ALL?**

3. Press <MENU/OK> to show CONFIRM?

4. Press <MENU/OK> to confirm the delete, and briefly display EMPTY.

4.20 Find the Cordless Handset

You can locate any cordless handsets by paging from the base unit:

1. In idle mode, press <MENU/OK> and <UP/DOWN> to select

PAGE ALL HS.

2. Press <MENU/OK>. **"PAGING"** will flash on the base screen.

All handsets registered to the base will produce the paging tone and **"PAGING"** flashes on the screen. You can stop the paging by pressing <TALK> / <OFF> / <C/MUTE> on any handset or <C/MUTE> on the base to stop paging.





4.21 Make an Internal Call

This feature allows you to make internal calls, transfer external calls and make conference calls. If the called base or handset is not answered within 60 seconds, the called base or handset will stop ringing and the calling one will return to standby mode. (Or after 100 seconds if calling from the base.)

4.21.1 Intercom

Using a cordless handset:

1. In idle mode, press <C/MUTE/> and all the other registered handset numbers will display, along with a "7" and a "9".
2. Enter 7 to call the base or enter the number of the handset that you want to call, or enter <9> to call all handsets and the base.
3. The called handset rings. Press <TALK> on the called handset to establish the internal call.

OR

3. The called base rings. Lift up the corded handset on the called base to establish the internal call.

Note: If only one cordless handset is registered to the base station, pressing <C/MUTE> will call the base immediately.

Note: If there is an external call while you are on an intercom call, you'll hear warning beeps, and will have to end the intercom call before you can answer the external call.

Using the corded base:

1. In idle mode, press <C/MUTE> and the registered handset numbers will display, along with a "9".
2. Enter the handset number you want to call, or press "9" to call all handsets.
3. The called handset rings. Press <TALK> on the called handset to establish the internal call.

Note: If only one handset is registered to the base station, pressing <C/MUTE> will call the handset immediately.

4.21.2 Call All Handsets

Using a cordless handset:

1. In idle mode, press <C/MUTE> and the registered handset numbers will display.
2. Press <9> to ring to all registered handsets and the base.

Using the corded base:

1. In idle mode, press <C/MUTE> and the registered handset numbers will display, along with a "9".
2. Press "9" to ring to all registered handsets.





4.21.3 Transfer an External Call

Using a cordless handset:

During an external call:

1. Press <MENU/OK> and <UP/DOWN> to select INTERCOM.
2. Press <MENU/OK> to show all the other registered handset numbers, plus a "7" and a "9".
Enter the number for the handset/base you want to transfer the call to.
3. The external call is put on hold automatically and the called handset/base rings.
4. Press <TALK> on the called handset, or pick up the corded handset on the base, to establish an internal call.
5. Press <TALK OFF> on the calling handset or put the calling handset on the charging cradle to end the current call with the external party.
6. The external call is transferred to the called handset/base.

Note: If the other handset has not answered the intercom call, you can stop the intercom and return to the external call by pressing <TALK OFF> at any time.

If the other handset does not answer the intercom call within 30 seconds, the intercom will stop and you will return to the external call automatically.

Using the corded base:

During an external call:

1. Press <MENU/OK> and enter the number of the handset you want to call, or enter "9" to call all the handsets.
2. The external call is put on hold automatically and the called handset rings.
3. Press <TALK> on the called handset to establish an internal call.
4. Replace the corded handset on to the base to end the current call with the external party.
5. The external call is transferred to the called handset.





4.21.4 Make a 3-way Conference Call

The conference call feature allows one external call to be shared with the base and one handset or with two handsets . The three parties can share the conversation and no additional network subscription is required.

Using a cordless handset:

During an external call:

1. Follow Steps 1 to 4 in section 4.21.3.
2. Press and hold the <*> key on the calling handset to establish the conference call.

Either handset/base can exit the conference by pressing <TALK OFF> or replacing the handset on the cradle, leaving the other handset/base still connected to the external call.

Using the corded base:

During the external call:

1. Follow Steps 1 to 3 in section 4.21.3 (corded).
2. Press and hold the "*" key on the calling base to establish the conference call.

Any party (base or handset) can exit the conference and leave the other party still connected to the external call.





5 PRIVATE PHONEBOOK

Your phone can store up to 50 private phonebook entries with names and numbers in each handset and 50 entries in the base. Each phonebook entry can have a maximum of 20 digits for the phone number and either 8 characters (cordless handsets) or 12 characters (base) for the name. You can also select different ringtones for your phonebook entries. (Note: the different ringtones only play when you receive a call if you subscribe to Caller Display and the incoming number matches the stored number.) Phonebook entries are stored alphabetically by name.

Using a cordless handset:

5.1 Add a New Phonebook Entry

1. From idle mode, press <MENU/OK> to show CONTACTS and then press <MENU/OK> to enter the contacts list.
2. Press <MENU/OK> to show ADD.
3. Press <MENU/OK> and then to enter the name, up to 8 characters.
4. Press <MENU/OK> and then to enter the number, up to 20 digits.
5. Press <MENU/OK> and <UP/DOWN> to select the desired ringtone for your phonebook entry.
6. Press <MENU/OK> to store the phonebook entry.

5.2 Search for a Phonebook Entry

1. From idle model, press <MENU/OK> to show CONTACTS and then press <MENU/OK> to enter the contacts list.
2. Enter the first letter of the name using the alphanumeric keys (e.g. if it begins with C, press the 2 key three times), and then press <UP/DOWN> to scroll to the entry you want.

5.3 View a Phonebook Entry

1. From idle model, press <MENU/OK> to show CONTACTS and then press <MENU/OK> to enter the contacts list.
2. Press <UP/DOWN> to select the desired contact entry.
3. Press <MENU/OK> and <UP/DOWN> to select VIEW.
4. Press <MENU/OK> and <UP/DOWN> to review the name, number and melody of the selected phonebook entry.

Note: If number is more than 8 digits, press the <*> key or <#> key to view the remaining digits.





5.4 Edit a Phonebook Entry

1. From idle model, press <MENU/OK> to show CONTACTS and then press <MENU/OK> to enter the contacts list.
2. Press <UP/DOWN> to select the desired contact entry.
3. Press <MENU/OK> and <UP/DOWN> to select EDIT.
4. Press <MENU/OK> to display the current name.
5. Edit the name using the <C/MUTE> key to delete letters, and press <MENU/OK> to confirm the name.
6. Edit the number using the <C/MUTE> key to delete numbers, and press <MENU/OK> to confirm the number.
7. Press <UP/DOWN> to select the ringtone and press <MENU/OK> to confirm.

5.5 Delete a Phonebook Entry

1. From idle model, press <MENU/OK> to show CONTACTS and then press <MENU/OK> to enter the contacts list.
2. Press <UP/DOWN> to select the contact entry you want to delete.
3. Press <MENU/OK> and <UP/DOWN> to select DELETE.
4. Press <MENU/OK> to confirm, and the entry will be deleted.

5.6 Delete All Phonebook Entries

1. Press <MENU/OK> to show CONTACTS and then press <MENU/OK> to enter the contacts list.
2. Press <MENU/OK> and <UP/DOWN> to select DEL ALL .
3. Press <MENU/OK> to show CONFIRM?
4. Press <MENU/OK> to confirm. All entries will be deleted and the display will show EMPTY.

5.7 Check the Phonebook Usage

You can check how many contact entries are stored in your handset and how many empty spaces remain in the Contacts list.

1. Press <MENU/OK> to show CONTACTS and then press <MENU/OK> to enter the contacts list.
2. Press <MENU/OK> and <UP/DOWN> to select CAPACITY.
3. Press <MENU/OK> to display how much of the contacts phonebook is being used, for example <14/50> means 14 entries are stored out of the total of 50 available spaces





5.8 Set the Fast Dial Numbers

Up to 8 of your Contact entries can be allocated to a fast dial key (from 2 to 9), where you can dial the number from idle mode by simply pressing and holding the appropriate digit key for more than 2 seconds. If no fast dial number is stored, you will hear a double-beep tone when the key is held down.

5.8.1 Add or Edit a Fast Dial Number

1. Press <MENU/OK> to show CONTACTS and then press <MENU/OK> to enter the contacts list.
2. Press <MENU/OK> and <UP/DOWN> to select FASTDIAL .
3. Press <MENU/OK> and <UP/DOWN> to show the digit key from 2 to 9 that you want to set. Then press <MENU/OK> to select it.

If EMPTY is displayed briefly, there is no number stored in the selected key:

4. Press <UP/DOWN> to select an entry from the contacts list.
 5. Press <MENU/OK> to save the new number in the selected fastdial key.
- OR if a name displays, there is already a number stored in the selected key:
4. Press <MENU/OK> to select EDIT.
 5. Press <MENU/OK> and then <UP/DOWN> to select an entry from the contacts list.
 6. Press <MENU/OK> to save the new number in the selected fastdial key.

5.8.2 Delete a Fast Dial Number

1. Repeat the steps 1 to 3 in section 5.8.1.
2. Press <MENU/OK> and <UP/DOWN> to select DELETE.
3. Press <MENU/OK> to confirm the delete.





Using the corded base:

5.9 Add a New Entry

In idle:

1. Press <MENU/OK> to show **PHONEBOOK**.
2. Press <MENU/OK> and <UP/DOWN> to show **ADD**.
3. Press <MENU/OK> and the display will show the cursor at the beginning of the name position.
4. Key in the name using the digit keys (maximum 12 characters). If you make any mistakes, press <C/MUTE> to delete the last character.
5. Press <MENU/OK> and the cursor will move to the beginning of the number position.
6. Key in the number using the digit keys (maximum 20 digits). If you make any mistakes, press <C/MUTE> to delete the last digit.



- 
- 
- 
- 
7. Press <MENU/OK> to show **MELODY 1**
Use <UP/DOWN> to scroll through the melodies (there are 10 melodies to choose from).
 8. Press <MENU/OK> to confirm the melody and store the entry in the phonebook.

Note: If there is no more space in the phonebook, **"MEM IS FULL"** will appear on the display.

5.10 Edit an Entry

In idle:

1. Press <MENU/OK> to show **PHONEBOOK**.
2. Press <MENU/OK> and <UP/DOWN> to show **EDIT**.
3. Press <MENU/OK> and the display will show the first phonebook entry in alphabetical order.
4. Scroll <UP/DOWN> until you see the contact you want to edit.
5. Press <MENU/OK> and the cursor will appear at the end of the name.
6. Edit the name, pressing <C/MUTE> to delete characters, if necessary.
7. Press <MENU/OK> and the cursor will appear at the end of the number.
8. Edit the number, pressing <C/MUTE> to delete digits, if necessary.
9. Press <MENU/OK> and the display will show the current melody choice. Press <UP/DOWN> to change the melody, if required.
10. Press <MENU/OK> to save the changes.

5.11 View an Entry

In idle:

1. Press <PHONEBOOK> to display the first phonebook entry in alphabetical order.

OR

1. Press <MENU/OK> three times to display the first phonebook entry.
2. Enter the first letter of the name you want to view using the alphanumeric keys and then scroll <UP/DOWN> to find the entry you want.

Note: if no name matches with the first letter you entered, the next nearest phonebook entry will be displayed.)

OR

2. Press <UP/DOWN> to select and view the desired phonebook entry. The display will show the number and name.
3. Press <Menu/OK> to show the associated melody instead of the name.



5.12 Delete an Entry

In idle:

1. Press <MENU/OK> to show **PHONEBOOK**.
2. Press <MENU/OK> and <UP/DOWN> to show **DELETE**.
3. Press <MENU/OK> and <UP/DOWN> to select the desired phonebook entry.
4. Press <MENU/OK> to display "**CONFIRM?**".
5. Press <MENU/OK> to confirm the delete, or <C/MUTE> to cancel the delete.

5.13 Delete All Phonebook Entries

In idle:

1. Press <MENU/OK> to show **PHONEBOOK**.
2. Press <MENU/OK> and <UP/DOWN> to show **DELETE ALL**.
3. Press <MENU/OK> to display "**CONFIRM?**".
4. Press <MENU/OK> to confirm the delete, or <C/MUTE> to cancel the delete.

5.14 View Phonebook Capacity

In idle:

1. Press <MENU/OK> to show **PHONEBOOK**.
2. Press <MENU/OK> and <UP/DOWN> to show **PB STATUS**.
3. Press <MENU/OK> to display how much of the phonebook is being used, for example "33/50 USED" means 33 entries are stored out of the total 50 available spaces.



6 CALLER DISPLAY (NETWORK DEPENDENT)

This feature is available if you have subscribed to the Caller Display service with your network service provider. Your phone can store up to 20 received calls with date/time information in the base Call Log, and up to 20 in the cordless handset Call Log. The number will be shown on the handset and base displays when the phone is ringing. If the number matches with one of the entries in your base and/or handset Phonebook, the caller's name stored in that phonebook will be displayed alternately with the number on the handset, and with the number on the base.

The handset and base will ring with the melody associated with that phonebook entry.

If the call is from someone who withheld their number, e.g. by dialling 141, "**WITHHELD**" will display.

If the call is from someone whose number is unavailable, e.g. an international call or from a private exchange, "**OUT OF AREA**" or "**OUT AREA**" will display.

If you've got new Caller Display records, the handset will display "X CALLS" in standby mode, and the base will have "NEW X" on its display, where X is the number of new calls.

Using a cordless handset:

6.1 View the Call Log

All received calls are saved in the call log with the latest call at the top of the list. When the call log is full, the oldest call will be replaced by a new call. Any unanswered calls which have not been viewed are marked with a <★> at the top of the display.

1. Press <UP> to access the call list.

Or

Press <MENU/OK> then <UP/DOWN> to show CALL LOG and then <MENU/OK> to select it.

2. Press <UP/DOWN> to select the desired entry.

3. Press <#> to view the caller's number if applicable.

4. Press <MENU/OK> then <UP/DOWN> to show DETAILS, and then <MENU/OK> to display the date of the call. Press <#> to see the time of the call, and press <MENU/OK> to return to the name or number.



6.2 Store a Call Log Number into the Contacts

1. Follow Steps 1 and 2 in Section 6.1.
2. Press <MENU/OK> and <UP/DOWN> to show STORE.
3. Press <MENU/OK> and then to enter the name.
4. Press <MENU/OK> and the selected call log number is displayed.
5. Edit the number if necessary.
6. Press <MENU/OK> and <UP/DOWN> to select the ringtone.
7. Press <MENU/OK> to store the entry in the Contacts list, and return to the Call Log.

6.3 Delete an Entry from the Call Log

1. Follow Steps 1 and 2 in Section 6.1.
2. Press <MENU/OK> and <UP/DOWN> to show DELETE.
3. Press <MENU/OK> to confirm.

6.4 Delete all Call Log Entries

1. Follow Steps 1 and 2 in Section 6.1.
2. Press <MENU/OK> and <UP/DOWN> to show DEL ALL .
3. Press <MENU/OK> to display CONFIRM?.
4. Press <MENU/OK> to confirm. All entries will be deleted and the display will show EMPTY.

6.5 Call Log Category

You can set the handset to record all received calls or only missed calls in the Call Log.

1. Follow Steps 1 and 2 in Section 6.1.
2. Press <MENU/OK> and <UP/DOWN> to show CATEGORY.
3. Press <MENU/OK> and then <UP/DOWN> to show ALL or MISSED.
4. Press <MENU/OK> to confirm the chosen option.



Using the corded base:

6.6 View the Call Log

All calls are saved in the Call Log, either as MISSED or RECEIVED calls, with the latest call at the top of the list. When the call list is full, the oldest call will be replaced by a new call. Any unanswered call which has not been read is marked with the <NEW> icon when viewed, and the number of new calls is shown at the top right of the screen in idle mode.

1. Press <CALLS> to see the most recent Missed call record in the Call Log.
or Press <MENU/OK>, <DOWN>, <MENU/OK> to show MISSED, then press <MENU/OK> to see the most recent Missed call record in the Call Log, or press <DOWN> to show RECEIVED and then press <MENU/OK> to see the most recent Received call in the Call Log.
2. Press <UP/DOWN> to scroll through the Call Log.
3. The <NEW> icon will be displayed in the idle screen until all new calls have been reviewed in the Call Log.

6.7 Store a Call Log Number into the Phonebook

1. Follow steps 1 and 2 in Section 6.6.
2. Press <MENU/OK> to show **ADD TO PB?**
3. Press <MENU/OK> and the display will show the cursor at the beginning of the name position.
4. Enter the name using keypad.
5. Press <MENU/OK> to confirm the name.
6. The number is shown with the cursor at the end. Modify the number, if necessary, using the <C/MUTE> and digit keys.
7. Press <MENU/OK> to confirm the number, and display **MELODY 1**.
8. Press <UP/DOWN> to scroll through the melodies.
9. Press <MENU/OK> to confirm your selection. You will hear a confirmation tone, and the display will return to the call log.

6.8 Delete an Entry in the Call Log

1. Follow steps 1 and 2 in Section 6.6.
2. Press <MENU/OK> and then <UP/DOWN> to show **DELETE?**
3. Press <MENU/OK> to show **CONFIRM?**
4. Press <MENU/OK> to delete the entry.

6.9 Delete All Call Log Entries □□

1. Follow steps 1 and 2 in Section 6.6.
2. Press <MENU/OK> and then <UP/DOWN> to show **DELETE ALL?**
3. Press <MENU/OK> to show **CONFIRM?**
4. Press <MENU/OK> to delete all entries, and display **EMPTY**.



7 PHONE SETTINGS

Your phone comes with a selection of settings that you can change to personalise your phone the way you like it to work.

Using a cordless handset:

7.1 Clock Settings

If you subscribe to the Caller Display service, the time and date settings will be updated automatically when you receive an incoming call, although you may need to set the correct year. Otherwise you will need to set the correct time and date so that you know when you received answering machine messages, or if you want to display the time in standby mode.

7.1.1 Change the Date Format

1. Press <MENU/OK> and <UP/DOWN> to show CLOCK .
2. Press <MENU/OK> and <UP/DOWN> to select DATE FMT.
3. Press <MENU/OK> and then <UP/DOWN> to choose a date format of either DDMMYY or MMDDYY.
4. Press <MENU/OK> to confirm your choice.

7.1.2 Change the Time Format

1. Press <MENU/OK> and <UP/DOWN> to show CLOCK .
2. Press <MENU/OK> and <UP/DOWN> to select TIME FMT.
3. Press <MENU/OK> and then <UP/DOWN> to choose a time format of either 12HR or 24HR.
4. Press <MENU/OK> to confirm your choice.

7.1.3 Set the Time

1. Press <MENU/OK> and <UP/DOWN> to show CLOCK .
2. Press <MENU/OK> and <UP/DOWN> to select SET TIME.
3. Press <MENU/OK> and then to enter the time information in 24 hour format.
4. Press <MENU/OK> to confirm your setting.

Note: If time has been set before, the current time will display, otherwise, "HH:MM" will display.

7.1.4 Set the Date

1. Press <MENU/OK> and <UP/DOWN> to show CLOCK .
2. Press <MENU/OK> and <UP/DOWN> to select SET DATE.
3. Press <MENU/OK> and then enter the date information in the format you set in section 7.1.1.
4. Press <MENU/OK> to confirm your setting.

Note: If date has been set before, the current date will display, otherwise, "DDMMYY" will display.





7.2 Alarm Settings

You can set an alarm time on the cordless handset. When an alarm is set, the <🔔> is shown on the handset display.

When the alarm time is reached, the <🔔> and "ALARM ON " flash on the handset display, and the alarm tone rings for 45 seconds. You can press any key to disable the alarm. If the snooze function is activated, the alarm will sound again at the end of the snooze period of 7 minutes. You can also press and hold <TALK OFF> while the alarm is sounding, to stop the alarm and turn off the snooze function.

Note:

- a. A key press will still disable the alarm even if the handset keypad is locked when the alarm rings.
- b. The alarm volume level is the same as the settings of the handset ringer volume. If the handset ringer is set to OFF, the alarm still sounds at VOLUME 1 level.
- c. During an external call or internal call, if an alarm is set and when the alarm time is reached, the <🔔> and "ALARM ON " will still flash. An alarm tone will be emitted from the earpiece to alert the user the alarm time is reached. Once the user presses any key or presses and holds <TALK OFF> to disable the alarm, the display will revert to the call duration .
- d. During paging or ringing, the alarm will not sound when the alarm time is reached. However, if the snooze function is enabled and there is no paging or ringing, the alarm will sound again at the end of the snooze period.

7.2.1 Turn on/off the Alarm

1. Press <MENU/OK> and <UP/DOWN> to select ALARM .
2. Press <MENU/OK> and <UP/DOWN> to show ON or OFF .
3. Press <MENU/OK> to confirm your choice.

Note: If ON is selected, you will be prompted to set the alarm time.

7.2.2 Set the AlarmTime (if the Alarm is set to be ON)

1. Follow Steps 1 to 3 in Section 7.2.1.
2. Enter the alarm time in 24 hour format.
3. Press <MENU/OK> to display SNOOZE.
4. Press <MENU/OK> and <UP/DOWN> to show ON or OFF.
5. Press <MENU/OK> to confirm your setting.





7.3 Handset Settings

7.3.1 Ringer Setup

7.3.1.1 Set the Ringer Melody for Internal Calls

1. Press <MENU/OK> and <UP/DOWN> to select HS SET.
 2. Press <MENU/OK> and <UP/DOWN> to select RINGER.
 3. Press <MENU/OK> and <UP/DOWN> to select INT RING.
 4. Press <MENU/OK> and <UP/DOWN> to select your intercom ringtone.
- Note:** There are 10 ring tones, and each will play as you step through the list.
5. Press <MENU/OK> to confirm.

7.3.1.2 Set the Ringer Melody for External Calls

1. Press <MENU/OK> and <UP/DOWN> to select HS SET.
 2. Press <MENU/OK> and <UP/DOWN> to select RINGER.
 3. Press <MENU/OK> and <UP/DOWN> to select EXT RING.
 4. Press <MENU/OK> and <UP/DOWN> to select your external ringtone.
- Note:** There are 10 ring tones, and each will play as you step through the list.
5. Press <MENU/OK> to confirm.

7.3.1.3 Set the Ringer Volume

1. Press <MENU/OK> and <UP/DOWN> to select HS SET.
 2. Press <MENU/OK> and <UP/DOWN> to select RINGER.
 3. Press <MENU/OK> and <UP/DOWN> to select RING VOL.
 4. Press <MENU/OK> and <UP/DOWN> to select the desired ringer volume (a total of 6 ringer volume levels including OFF).
- Note:** The respective ringer volume will be played during your selection. If OFF is selected, the ringer off icon will be displayed after confirming.
5. Press <MENU/OK> to confirm.

7.3.2 Set Alert Tones

Three different alert tones are on by default, but can be set off, if desired.

Key Tone - a single beeper is emitted when you press a key.

Low Battery Tone - emitted while you are talking on the phone to alert you that you need to charge the handset batteries.

Out of Range Tone - emitted while you are talking on the phone to alert you to move closer to the base unit, before the call is lost.

1. Press <MENU/OK> and <UP/DOWN> to select HS SET.
2. Press <MENU/OK> and <UP/DOWN> to select TONE.
3. Press <MENU/OK> and <UP/DOWN> to select KEY TONE / LOW BATT / OUTRANGE .
4. Press <MENU/OK> and <UP/DOWN> to turn these tones ON or OFF.
5. Press <MENU/OK> to confirm.





7.3.3 Set the Equalizer

The phone has three different frequency range filters (NATURAL, BASS, TREBLE) that you can set, to adjust the sound in the earpiece to suit your preference.

1. Press <MENU/OK> and <UP/DOWN> to select HS SET.
2. Press <MENU/OK> and <UP/DOWN> to select EQLIZER.
3. Press <MENU/OK> and <UP/DOWN> to select NATURAL, BASS or TREBLE.
4. Press <MENU/OK> to confirm the setting.

7.3.4 Select Base

If you have registered the handset to more than one base, you can select any one of them to use with your handset. Note: you can only use the handset with one base at any one time.

1. Press <MENU/OK> and <UP/DOWN> to select HS SET.
2. Press <MENU/OK> and <UP/DOWN> to select SEL BASE.
3. Press <MENU/OK> and <UP/DOWN> to select the desired base.
(Note: the currently selected base is indicated by a *.)
4. Press <MENU/OK> to confirm.

Note: the handset may take a short while to search for the new base.

7.3.5 Set the Handset Language

The language used on the handset display may be changed from English, if required.

1. Press <MENU/OK> and <UP/DOWN> to select HS SET.
2. Press <MENU/OK> and <UP/DOWN> to select LANGUAGE.
3. Press <MENU/OK> and <UP/DOWN> to select the desired language.
4. Press <MENU/OK> to confirm.

7.3.6 Rename the Handset

The handset name, displayed in the standby mode (default HS), can be changed to any other name of up to 6 letters.

1. Press <MENU/OK> and <UP/DOWN> to select HS SET.
2. Press <MENU/OK> and <UP/DOWN> to select HS NAME.
3. Press <MENU/OK> and then change the name, using <C> to delete letters and the alphanumeric keys to enter up to 6 letters for your new handset name.
4. Press <MENU/OK> to confirm.





7.3.7 Choose the Information to be displayed in Idle

You can choose to display the time or handset name in your idle screen.

1. Press <MENU/OK> and <UP/DOWN> to select HS SET.
2. Press <MENU/OK> and <UP/DOWN> to select DISPLAY.
3. Press <MENU/OK> and <UP/DOWN> to select HS NAME or TIME.
4. Press <MENU/OK> to confirm.

7.3.8 Set the Auto Answer

If you turn on the Auto Answer, you can answer a call automatically by just lifting the handset off a charger, without having to press any key.

1. Press <MENU/OK> and <UP/DOWN> to select HS SET.
2. Press <MENU/OK> and <UP/DOWN> to select AUTO ANS.
3. Press <MENU/OK> and <UP/DOWN> to turn ON or OFF the auto answer feature.
4. Press <MENU/OK> to confirm.

7.3.9 Set the Direct Memory Keys

There are three direct memory keys M1, M2 and M3. You can store a number of up to 20 digits into each of these keys and dial them directly from idle mode, by pressing and holding the key for more than 2 seconds.

1. Press <MENU/OK> and <UP/DOWN> to select HS SET.
2. Press <MENU/OK> and <UP/DOWN> to select MEM KEY.
3. Press <MENU/OK> and <UP/DOWN> to select the desired memory key from M1, M2 and M3.
4. Press <MENU/OK> and then enter a new number or edit the number stored already.
5. Press <MENU/OK> to confirm.

7.3.10 Set the Mailbox Number

You can store a number of up to 20 digits, which can be dialled out directly from idle mode by pressing and holding the digit <1> key for more than 2 seconds. This may be used to store your network voice mail number, such as 1571, for easy access to that service.

1. Press <MENU/OK> and <UP/DOWN> to select HS SET.
2. Press <MENU/OK> and <UP/DOWN> to select MAILBOX.
3. Press <MENU/OK> and then enter a new number or edit any existing mailbox number.
4. Press <MENU/OK> to confirm.





7.4 Base Settings

7.4.1 De-register a Handset

This operation should only be necessary if one of your cordless handsets becomes faulty or lost and needs to be replaced.

You will need to enter the 4-digit system PIN (Default PIN is 0000) in order to de-register a handset from the base station. A de-registered handset will have the antenna flashing and --UNREG-- on the display.

Note: You cannot de-register the handset that you are currently using.

1. Press <MENU/OK> and <UP/DOWN> to select BS SET.
2. Press <MENU/OK> and <UP/DOWN> to select DEL HS.
3. Press <MENU/OK> and the display shows PIN?---
4. Enter the 4-digit system PIN.
5. Press <MENU/OK> and the first handset number is displayed.
6. Press <UP/DOWN> to step through the list of registered handsets, and select the number of the handset you want to de-register.
7. Press <MENU/OK> to confirm, and the chosen handset will be de-registered.

7.4.2 Change the Dial Mode

You should normally leave the Dial Mode at its default setting of TONE (also called DTMF) unless the phone is connected to an old exchange that only recognises PULSE dialling.

Note: If PULSE dialling is set, you can press the * key to switch to TONE dialling for the rest of that call.

1. Press <MENU/OK> and <UP/DOWN> to select BS SET.
2. Press <MENU/OK> and <UP/DOWN> to select DIALMODE.
3. Press <MENU/OK> and <UP/DOWN> to select TONE or PULSE.
4. Press <MENU/OK> to confirm.



7.4.3 Change the Recall (Flash) Time

You may need to change the recall (flash) time if your phone is connected to a PBX. The recall time options are SHORT (the default value of 100ms), MID (300ms) or LONG (600ms).

1. Press <MENU/OK> and <UP/DOWN> to select BS SET.
2. Press <MENU/OK> and <UP/DOWN> to select FLASH .
3. Press <MENU/OK> and <UP/DOWN> to select your desired recall(flash) time (SHORT, MID, LONG).
4. Press <MENU/OK> to confirm.

7.4.4 Change the System PIN Code

A 4-digit system PIN code is used for changing the system settings of the base station. It is used to protect your phone against unauthorised use.

The default system PIN code is 0000.

1. Press <MENU/OK> and <UP/DOWN> to select BS SET.
2. Press <MENU/OK> and <UP/DOWN> to select CHG PIN.
3. Press <MENU/OK> and the display shows OLD PIN?
4. Press <MENU/OK> and the enter the old system PIN.
5. Press <MENU/OK>, the display shows NEW PIN?, press <MENU/OK> and enter your new 4-digit system PIN.
6. Press <MENU/OK>, the display shows CONFIRM?, press <MENU/OK> and enter your new 4-digit system PIN again.

Note: If the new PIN entered in Step 6 is not the same as the new system PIN entered in Step 5, you must enter your new PIN at step 5 again.

7. Press <MENU/OK> to confirm.

7.4.5 Reset Your Cordless Phone

You can reset your phone to the default settings. After reset, all your personal settings including your PIN numbers, the redial list and call log entries will be deleted, and all answering machine messages will be erased, but your phonebook remains unchanged, although the direct memory keys (M1-3) and the Mailbox (key 1) memory will be deleted.

1. Press <MENU/OK> and <UP/DOWN> to select DEFAULT .
2. Press <MENU/OK> and you are requested to enter the 4-digit PIN (default = 0000)
3. Enter the 4-digit system PIN.
4. Press <MENU/OK> to show CONFIRM?
5. Press <MENU/OK> again to confirm the reset.

Using the corded base:

7.5 Set Date and Time

The format for the date is YYYY-MM-DD, and the time is HH:MM in either 12-hour or 24-hour format.

1. Press <MENU/OK> and <UP/DOWN> to select **DATE & TIME**.
2. Press <MENU/OK> to show **TIME FORMAT**. Select this if you want to change between 12-hour and 24-hour formats. Otherwise, press <UP/DOWN> to show **SET CLOCK**.
3. Press <MENU/OK> and the 4-digit year is displayed with the last two digits of the year flashing.
4. Press <UP/DOWN> to set the year.
5. Press <MENU/OK> and the month field will flash.
6. Press <UP/DOWN> to set the month.
7. Press <MENU/OK> and the date field will flash.
8. Press <UP/DOWN> to set the date.
9. Press <MENU/OK> and the hour field will flash.
10. Press <UP/DOWN> to set the hour in the time format set.
11. Press <MENU/OK> and the minutes field will flash.
12. Press <UP/DOWN> to set the minutes.
13. Press <MENU/OK> to confirm and you will hear a beep and the display will return to the idle screen.

7.6 De-register a Handset

This operation should only be necessary if one of your handsets becomes faulty or lost and needs to be replaced.

You will need to enter the 4-digit system PIN in order to de-register a handset from the base station. (The default PIN is 0000.)

A de-registered handset will have the antenna icon flashing and REGISTER on the display.

1. Press <MENU> and <UP/DOWN> to select **SETTINGS**.
2. Press <OK> and <UP/DOWN> to select **DELETE HS**.
3. Press <OK> and the display will show **"PIN?"**, enter a 4-digit PIN code (default setting is 0000).
4. Press <MENU/OK> and the first registered handset number is shown.
5. Press <UP/DOWN> to step through the list of registered handsets and select the one you want to de-register.
6. Press <MENU/OK> and the selected handset will be de-registered.

Note: Press <C/MUTE> to return to the previous menu at any time.



7.7 Ringer Setup

7.7.1 Change Ringer Melody

There are 10 base ringer melodies from 1 to 10, and you can set a different ringer melody for internal and external calls.

1. Press <MENU/OK> and <UP/DOWN> to select **SETTINGS**.
2. Press <MENU/OK> to show **RING SETUP**.
3. Press <MENU/OK> and <UP/DOWN> to select **EXT RING** or **INT RING**.
4. Press <MENU/OK> and the display will show **MELODY**. Then press <MENU/OK> to show **MELODY 1**.
5. Press <UP/DOWN> to scroll through the Melody list (from 1 to 10).
6. Press <MENU/OK> to confirm the setting.

Note: The respective ringer melody will be played during your selection.

7.7.2 Change Ringer Volume

You can adjust the volume level of the ringer for internal calls (INT RING) and external calls (EXT RING) separately, with settings from 1 (the quietest) to 5 (loudest), or turn it OFF.

1. Follow steps from 1 to 3 in section 7.7.1.
2. Press <MENU/OK> <UP/DOWN> to select **VOLUME**. Then press <MENU/OK> and <UP/DOWN> to step through the volume level list Off, 1 to 5.
3. Press <MENU/OK> to confirm the setting.

Note: The respective ringer volume will be played during your selection.

If **VOLUME OFF** is selected, the <Ringer Off> icon will display.

7.8 Set the Dial Mode

You should normally leave the dialling mode at its default setting of TONE (also called DTMF) unless the phone is connected to an old exchange that only recognises PULSE dialling.

In Idle:

1. Press <MENU/OK> and <UP/DOWN> to select **SETTINGS**.
2. Press <MENU/OK> and <UP/DOWN> to select **DIAL MODE**.
3. Press <MENU/OK> and <UP/DOWN> to select **TONE** or **PULSE**.
4. Press <MENU/OK> to confirm.





7.9 Set the Recall (Flash) Time

You may need to change the recall (flash) time if your phone is connected to a PBX. The recall time options are SHORT (the default value of 100ms), MEDIUM (300ms) or LONG (600ms).

In Idle:

1. Press <MENU/OK> and <UP/DOWN> to select **SETTINGS**.
2. Press <MENU/OK> and <UP/DOWN> to select **FLASH TIME**.
3. Press <MENU/OK> and <UP/DOWN> to select the desired flash time, from SHORT, MEDIUM and LONG.
4. Press <MENU/OK> to confirm.

7.10 Set the Key Tone

The Key Tone is a confirmation beep when you press any key. It is set on by default, but can be turned off, if desired.

In Idle:

1. Press <MENU/OK> and <UP/DOWN> to select **SETTINGS**.
2. Press <MENU/OK> and <UP/DOWN> to select **KEY TONE**.
3. Press <MENU/OK> and <UP/DOWN> to select **ON** or **OFF**.
4. Press <MENU/OK> to confirm.

7.11 Set the Base Language

In Idle:

1. Press <MENU/OK> and <UP/DOWN> to select **LANGUAGE**.
2. Press <MENU/OK> and <UP/DOWN> to select your desired language.
3. Press <MENU/OK> to confirm.

7.12 Change the System PIN

A 4-digit system PIN code is used for changing the system settings of the base station, and is used to protect your phone from unauthorised use. The default system PIN code is 0000.

1. Press <MENU/OK> and <UP/DOWN> to select **SETTINGS**.
2. Press <MENU/OK> and <UP/DOWN> to select **CHANGE PIN**.
3. Press <MENU/OK> and display will show **"PIN?"**, enter the 4-digit PIN (default setting is 0000) and press <MENU/OK>.
4. The display will show **"NEW PIN"**, enter the new PIN and press <MENU/OK>.
5. The display will show **"REPEAT"**, enter the new PIN again, and press <MENU/OK> to confirm.

Note: If the incorrect PIN is entered or the new PIN is not entered twice the same, an error tone will be emitted and it will return to the previous menu. If this takes a short time, press <C/MUTE> to return to the menu immediately.





7.13 Base Default

You can reset all of your base settings to their default settings. After a reset, all your personal base settings, call list entries, redial list entries, direct memory entries, and answering messages will be deleted, but any phonebook entries will be kept.

1. Press <MENU/OK> and <UP/DOWN> to select **SETTINGS**.
2. Press <MENU/OK> and <UP/DOWN> to select **BS DEFAULT**.
3. Press <MENU/OK> and display will show "**PIN?**", enter the 4-digit PIN (default setting is 0000).
4. Press <MENU/OK> to confirm, and base will return to the previous menu.



8 REGISTRATION

IMPORTANT: When you purchase a phone system, all handsets are already registered to your base, so you do not need to register them. Handset registration is only necessary when you buy extra handsets or if a handset has become faulty.

You can register additional handsets to have up to 5 handsets per base unit, with each handset's number (1 to 5) shown on its display.

Each handset can be registered to up to 4 different bases, but can only operate with one base at a time. (See 7.3.4 Select Base, for how to change between bases.)

To check whether a handset is registered, make sure mains power to the base unit is switched on and the handset is within range. The handset's display should show its number and the <Antenna icon> should be steadily on. If the display shows "- **UNREG** -", you need to register the handset again using the following process:

1. On the base station, press <MENU/OK> and <UP/DOWN> to show REGISTRATION, and then press <MENU/OK> to put the base station into registration mode. The base display will show "PLEASE WAIT" and the base will stay in registration mode for about 1 minute, so the following handset sequence must be completed within this time.
2. Press <MENU/OK> and <UP/DOWN> to select **REGISTER**.
3. Press <MENU/OK> to display **BASE 1**.
4. Press <UP/DOWN> to select which base number you want to use. (Note: a * will be shown next to any base numbers the handset is already registered with, and if selected the new registration will overwrite it.)
5. Press <MENU/OK> to display PIN?----.
6. Enter the 4-digit system PIN (default is 0000).
7. Press <MENU/OK> to confirm, and the display will show SEARCH'G.

If the handset registration is successful, the display will change to standby mode with the new handset number and the <antenna icon> will stop flashing. The handset will automatically be allocated the next available handset number. If the handset registration is unsuccessful, the <antenna icon> will still flash.

9 ANSWERING MACHINE (TAM)

Your phone includes a telephone answering machine that records unanswered calls when it is on. The display on the base will show the number of messages recorded.



The answering machine can store up to 59 messages within the maximum recording time of up to about 50 minutes, depending on the compression rate set (see section 9.5.7).

As well as recording incoming messages, you can record memos for other users of your phone. If the answering machine memory is full, the Handset will display **TAM FULL** alternately with the handset's name or time, depending on the handset standby display mode set (see section 7.3.7), and you will have to delete some messages before any new ones can be recorded.

You can turn the answering machine on or off using the base or handset. When the answering machine is set to **ON**, calls will be answered after the set answer delay and if the Answer and Record mode is set, the caller can then leave you a message. When the answering machine is set to **OFF**, calls will be answered after 14 rings and the answer only message will be played to your callers. They will not be able to leave you a message.

Using a cordless handset:

9.1 Turn On/Off the Answering Machine

1. Press <MENU/OK> and <UP/DOWN> to select TAM.
2. Press <MENU/OK> and <UP/DOWN> to select ON/OFF.
3. Press <MENU/OK> and <UP/DOWN> to select ON or OFF.
4. Press <MENU/OK> to confirm.
 - > If the answering machine is set to ON, the TAM icon <  > displays on the handset screen and the base station will display the new and total number of recorded messages.
 - > If the answering machine is set to OFF, the TAM icon <  > will not appear on the handset screen but the base station will still display the new and total number of recorded messages.
 - > If new messages are recorded, the TAM icon <  > flashes on the handset display and the TAM ON/OFF indicator flashes on the base, until all new messages have been played.

9.2 Listen to the Messages in the Answering Machine

Old messages will be played after all new messages are played completely.

1. Press <MENU/OK> and <UP/DOWN> to select TAM.
2. Press <MENU/OK> to show PLAYBACK .
3. Press <MENU/OK> to start message playback through the handset loudspeaker and the screen displays the date of the message received. Press <#> to see the time the message was received. Press < TALK/SPEAKERPHONE> to listen via the earpiece .

Note: The star icon<*> displays on the screen to indicate a new message, but once played, it will not be shown if you listen to that message again.

Note: If there are no new messages, the handset display will briefly show "00/00" then return to PLAYBACK.

4. During message playback, press <UP> or <DOWN> to increase or decrease the message playback volume respectively.

Note: After a new message is played, it will be saved as an old message automatically unless it is deleted.

5. Press <MENU/OK> then <UP/DOWN> to select STOP, FORWARD, PREVIOUS, DELETE to perform the following functions during message playback.
STOP: Stop the playback and return to the PLAYBACK menu.
FORWARD: Skip to play the next message,if there is another.
PREVIOUS: Repeat playing the current message from the beginning.
DELETE: Delete the current message and start playing the next.
6. Press <MENU/OK> to confirm the function.

Note: Alternatively, you can use the following shortcut keys to control different operations during message playback.

Press <Key 5> to stop message playback.

Press <Key 4> once to repeat the current message from the beginning.

Press <Key 4> twice to skip back to play the previous message.

Press <Key 6> to skip to play next message.

Press <Key 2> to delete the current message and start playing the next.



9.3 Delete All Messages in the Answering Machine

1. Press <MENU/OK> and <UP/DOWN> to select TAM.
2. Press <MENU/OK> and <UP/DOWN> to select DEL ALL .
3. Press <MENU/OK> to show CONFIRM?
4. Press <MENU/OK> to delete all old messages.

Note: The display briefly shows EMPTY and then returns to DEL ALL.

9.4 Record Memo

You can record your memo message for another user. When you record a memo, it is saved as a new message and can be played back in the same way as answering machine messages. Memo recording can still function even when the answering machine is turned off.

1. Press <MENU/OK> and <UP/DOWN> to select TAM.
2. Press <MENU/OK> and <UP/DOWN> to select MEMO.
3. Press <MENU/OK> to start memo recording and "RECORD'G" is displayed.
4. Press <MENU/OK> to stop memo recording. The display shows PLAYING and the memo is played back.
Press <MENU/OK> or let it finish playing to save the memo.

OR

4. Press <C/MUTE> at any time during RECORD'G or PLAYING to stop memo recording without saving and return back to the TAM menu.

9.5 Answering Machine Settings

You can use the SETTINGS menu in the handset to change the settings of your answering machine.

9.5.1 Set the Answer Mode

By default, the answer machine is set in ANS&REC mode which allows callers to leave a message.

This mode can be changed to ANSONLY which does not allow callers to leave a message, and callers should be prompted to call back later.

1. Press <MENU/OK> and <UP/DOWN> to select TAM
2. Press <MENU/OK> and <UP/DOWN> to select SETTINGS.
3. Press <MENU/OK> to show ANS MODE.
4. Press <MENU/OK> and <UP/DOWN> to select ANS&REC or ANSONLY
(The currently selected option is indicated with a *)
5. Press <MENU/OK> to confirm.





9.5.2 Set the Outgoing Message (OGM) Language

The answering machine announces the outgoing message(OGM) when it answers a call.

There is a pre-set OGM for each of ANS&REC mode or ANSONLY mode, which can be in English or French (FRANC,) on this model.

1. Press <MENU/OK> and <UP/DOWN> to select TAM.
2. Press <MENU/OK> and <UP/DOWN> to select SETTINGS.
3. Press <MENU/OK> and <UP/DOWN> to select LANGUAGE .
4. Press <MENU/OK> and <UP/DOWN> to select ENGLISH or FRANC.
5. Press <MENU/OK> to confirm.

9.5.3 Record Your Own Outgoing Message (OGM)

You can record your own OGM for ANS&REC mode or ANSONLY mode.

When you record your own OGM, it will be used when the answering machine answers the call. If your personal OGM is deleted, the pre-set OGM will be restored automatically.

1. Press <MENU/OK> and <UP/DOWN> to select TAM.
2. Press <MENU/OK> and <UP/DOWN> to select SETTINGS.
3. Press <MENU/OK> and <UP/DOWN> to select OGM SET.
4. Press <MENU/OK> and <UP/DOWN> to select ANS&REC or ANSONLY.
5. Press <MENU/OK> and <UP/DOWN> to select RECORD.
6. Press <MENU/OK> to start recording your personal OGM and "RECORD'G" is displayed on the screen.
7. Press <MENU/OK> to stop recording your personal OGM. Your new OGM will playback automatically.





9.5.4 Playback and Delete the Outgoing Message

You can listen to your own personal OGM or the pre-set OGM for ANS & REC mode or ANSONLY mode, or delete your personal OGM or record a new one at any time. Note: the pre-set OGM cannot be deleted.

9.5.4.1 Playback the OGM

1. Press <MENU/OK> and <UP/DOWN> to select TAM.
2. Press <MENU/OK> and <UP/DOWN> to select SETTINGS.
3. Press <MENU/OK> and <UP/DOWN> to select OGM SET.
4. Press <MENU/OK> and <UP/DOWN> to select ANS&REC or ANSONLY .
5. Press <MENU/OK> to show PLAYBACK .
6. Press <MENU/OK> to play your current OGM and "PLAYING" is displayed on the screen.
7. Press <MENU/OK> to stop the OGM playback or let it finish playing and return to the previous menu.

Note: If a personal OGM is not recorded, the pre-set OGM will play.

9.5.4.2 Delete a Personal OGM

1. Repeat Steps 1 to 6 in Section 9.5.4.1
2. Press <C/MUTE> while the OGM is playing to delete your personal OGM and restore the pre-set OGM automatically.

Note: If a pre-set OGM is playing, you cannot delete it, so pressing <C/MUTE> will just stop the playback and return to the previous menu.

9.5.5 Set the Answer Delay

You can set the number of rings before the answering machine answers and starts playing your OGM from two to eight rings or time saver (TS).

If time saver (TS) is set, the answering machine will answer after 6 rings if no new messages are recorded, or after 2 rings if there is a new message, so if you call in for remote access and it doesn't answer within 4 or 5 rings, you can hang up and save on call charges.

Note: If your network voice messaging service (e.g. BT 1571) is enabled, you will need to set the answer delay on your BB3825 to less than 6 rings, otherwise the network service will answer and record incoming calls, and prevent the BB3825 from recording them.

1. Press <MENU/OK> and <UP/DOWN> to select TAM.
2. Press <MENU/OK> and <UP/DOWN> to select SETTINGS.
3. Press <MENU/OK> and <UP/DOWN> to select ANS DLAY.
4. Press <MENU/OK> and <UP/DOWN> to select from 2 RINGS, 4 RINGS, 6 RINGS, 8 RINGS or TS. (The current set option is indicated by a "*".)
5. Press <MENU/OK> to confirm.





9.5.6 Set the Maximum Recording Time for Incoming Messages.

You can set the maximum length of the recording time of the incoming messages to be either 60 seconds, 120 seconds, 180 seconds or unlimited (up to the total recording time available).

1. Press <MENU/OK> and <UP/DOWN> to select TAM.
2. Press <MENU/OK> and <UP/DOWN> to select SETTINGS.
3. Press <MENU/OK> and <UP/DOWN> to select REC TIME
4. Press <MENU/OK> and <UP/DOWN> to select from 60S, 120S, 180S, or UNLIMIT. (The currently selected option is indicated with a "**".)
5. Press <MENU/OK> to confirm.

9.5.7 Change the Compression Rate

Three different compression rates (HIGH, MID and LOW) are provided for you to select different quality levels for recording incoming messages. The lower the compression rate, the higher the recording quality level attained, but the shorter the total recording time available. (LOW=20 minutes, MID=30 minutes, HIGH=50 minutes, approximately.)

1. Press <MENU/OK> and <UP/DOWN> to select TAM.
2. Press <MENU/OK> and <UP/DOWN> to select SETTINGS.
3. Press <MENU/OK> and <UP/DOWN> to select COMPRESS.
4. Press <MENU/OK> and <UP/DOWN> to select your desired compression rate. (The current set option is indicated with a "**".)
5. Press <MENU/OK> to confirm.

9.5.8 Remote Access

Your phone lets you check your messages, or otherwise operate your answering machine, by calling the answering machine when you are away from home and then entering a 4-digit remote access PIN from a tone-dialling phone, provided the Remote Access is activated (see 9.5.8.2). The 4-digit remote access PIN code is used to prevent other people from unauthorised access of your answering machine.





9.5.8.1 Change the 4-Digit Remote Access PIN

1. Press <MENU/OK> and <UP/DOWN> to select TAM.
2. Press <MENU/OK> and <UP/DOWN> to select SETTINGS.
3. Press <MENU/OK> and <UP/DOWN> to select CHG PIN.
4. Press <MENU/OK> to show OLD PIN?, press <MENU/OK> again and then enter the Old PIN. Default Remote Access PIN is 0000).
5. Press <MENU/OK> to show NEW PIN?, press <MENU/OK> again and then enter your new 4-digit PIN.
6. Press <MENU/OK> to show CONFIRM? Press <MENU/OK> again and then enter the New PIN again.

Note: If the new PIN entered in Step 6 is not the same as the new system PIN entered in Step 5, you must enter your new PIN at step 5 again.

7. Press <MENU/OK> to confirm.

9.5.8.2 Activate or Deactivate the Remote Access

The Remote Access is activated by default, but you can deactivate it to prevent any external access.

1. Press <MENU/OK> and <UP/DOWN> to select TAM.
2. Press <MENU/OK> and <UP/DOWN> to select SETTINGS.
3. Press <MENU/OK> and <UP/DOWN> to select REMOTE.
4. Press <MENU/OK> and <UP/DOWN> to select ON or OFF to turn the remote access on or off, respectively. (The currently selected option is indicated with a "**".)
5. Press <MENU/OK> to confirm.

9.5.8.3 Access Your Answering Machine Remotely

If you are away from home, you can call your answering machine from a tone-dialling phone to switch it on/off and/or listen to your messages remotely.

1. Place a call from a tone-dialling phone to your phone.
2. When the answering machine answers the call and starts playing the OGM, press the < * > key.
3. Enter the 4-digit Remote Access PIN (default value 0000). If the PIN is accepted, a long beep is played. If it is not accepted a multiple beep is played, and you must re-enter the PIN.

Note: The < * > can be entered during or after the OGM and the 4-digit PIN should follow without any delays.

Note: If the 4-digit Remote Access PIN is entered incorrectly three times consecutively, the line will be released automatically.

4. Press the following keys to carry out your desired remote function:



Keys	Functions	
	While message is not playing	While message is playing
2		Delete the current message playing
4		Press once to repeat playing the current message from the beginning. Press twice to skip back to the previous message.
5	Play the message	Stop the current message playback
6		Skip to play the next message
7	Turn on the answering machine	
9	Turn off the answering machine	

Note: If your answering machine is switched off, the phone will answer the call after 14 rings, and you can then press the < * > and enter the 4-digit remote access PIN (Default Remote Access PIN is 0000) to enter the remote access mode.

When your answering machine memory is full and the answer mode is in ANS&REC mode, the answer mode will change to ANSONLY automatically, and will not allow callers to leave messages, but will still answer incoming calls after the pre-set number of rings, to allow remote access.

It will change back to ANS&REC mode automatically after some messages have been deleted.

9.5.9 Call Screening

When the answering machine answers a call, the base will start call screening automatically and you will be able to hear the OGM and the incoming caller.

Adjust the base volume control, if necessary.

You cannot screen a call from a cordless handset.

At any time if you want to pick up the call, you can press <TALK> on the handset and the message recording will be stopped automatically. If the answering machine is in the process of recording, the message already stored will be saved.

Using the corded base:

9.6 Switching the TAM On/Off

When the TAM is switched on, the TAM ON/OFF indicator will be turned on, and it will flash if there are new messages recorded.

If the TAM is turned off, the TAM ON/OFF indicator will be off unless there are new messages.

9.6.1 Using the Direct Key

1. From idle mode, press <ANSWER ON/OFF> to switch TAM on or off.

9.6.2 Using the Menu

1. Press <MENU/OK> and <UP/DOWN> to select **ANS. MACHINE**.
2. Press <MENU/OK> and <UP/DOWN> to go to **TAM ON/OFF** and press <MENU/OK> to select.
3. Press <UP/DOWN> to select between **ON** and **OFF** then <MENU/OK> to select.

9.7 Outgoing Message Settings

9.7.1 Record your Outgoing Message (OGM)

You can record your own OGM for **ANS & REC** mode or **ANSWER ONLY** mode. When you record your own OGM, it will be used when the answering machine answers the call. If your personal OGM is deleted, the preset OGM will be restored automatically.

9.7.1.1 Using the direct key

9.7.1.1.1 Record your personal OGM

1. Make sure the TAM is set to the answer mode required, **ANS & REC** or **ANSWER ONLY**. (see section 9.8)
2. Press and hold <REPEAT> until you hear a beep and **RECORDING** appears on the Base display.
Then speak clearly from about 30cm (12 inches) away from the base to record your personal OGM.
3. When you want to end the recording, press the <PLAY/STOP> button.
The base will playback your new personal outgoing message and display **PLAYING OGM**.



9.7.1.2 Using the Menu

1. Press <MENU/OK> and <UP/DOWN> to select **ANS. MACHINE.**
2. Press <MENU/OK> and <UP/DOWN> to select **TAM SETTINGS.**
3. Press <MENU/OK> and <UP/DOWN> to select **OGM SETTINGS.**
4. Press <MENU/OK> and <UP/DOWN> to select **ANS & REC** or **ANSWER ONLY.**
5. Press <MENU/OK> and <UP/DOWN> to select **RECORD.**
6. Press <MENU/OK> to start recording your personal OGM and **“RECORDING”** is displayed on the screen.
7. Press <MENU/OK> to stop and save your personal OGM. Your newly saved OGM will playback automatically.

Note: Press <DELETE> at any time to return to the previous screen without saving the personal OGM.

9.7.2 Playback the Outgoing Message (OGM)

9.7.2.1 Using the direct key

Press <REPEAT> briefly to listen to the current OGM (ANS & REC or ANSWER ONLY).

9.7.2.2 Using the Menu

1. Press <MENU/OK> and <UP/DOWN> to select **ANS. MACHINE.**
2. Press <MENU/OK> and <UP/DOWN> to select **TAM SETTINGS.**
3. Press <MENU/OK> and <UP/DOWN> to select **OGM SETTINGS.**
4. Press <MENU/OK> and <UP/DOWN> to select **ANS & REC** or **ANSWER ONLY.**
5. Press <MENU/OK> and <UP/DOWN> to select **PLAYBACK.**
6. Press <MENU/OK> to playback your current OGM and **“PLAYING OGM”** is displayed on the screen.
7. Press <MENU/OK> to stop the OGM playback and return to the previous menu.

Note: If a personal OGM has not been recorded, the pre-set OGM will be played.

9.7.3 Delete a Personal OGM (Set OGM to DEFAULT)

9.7.3.1 Using the direct key

When the OGM is playing, press <DELETE> to delete your personal OGM and return to the previous menu, and the pre-set OGM is restored automatically.

Note: If a pre-set OGM is playing, you are not allowed to delete it, so pressing <DELETE> will have no effect.





9.7.3.2 Using the Menu

1. Press <MENU/OK> and <UP/DOWN> to select **ANS. MACHINE**.
2. Press <MENU/OK> and <UP/DOWN> to select **TAM SETTINGS**.
3. Press <MENU/OK> and <UP/DOWN> to select **OGM SETTINGS**.
4. Press <MENU/OK> and <UP/DOWN> to select **ANS & REC** or **ANSWER ONLY**.
5. Press <MENU/OK> and <UP/DOWN> to select **DEFAULT**.
6. Press <MENU/OK> to show PIN?, and then enter the system PIN (default 0000).
7. Press <MENU/OK> to replace the current OGM with the default OGM. The display will then return to the previous menu.

9.8 Switch Between OGMs

By default, the answer machine is set in **ANS & REC** mode which allows callers to leave a message. This mode can be changed to **ANSWER ONLY** which does not allow callers to leave a message. In that case, your callers will be prompted to call back later.

When the answering machine is switched ON, you can select **ANS & REC** or **ANSWER ONLY**.

Using the Menu



1. Press <MENU/OK> and <UP/DOWN> to select **ANS. MACHINE**.
2. Press <MENU/OK> and <UP/DOWN> to select **TAM SETTINGS**.
3. Press <MENU/OK> to show **ANSWER MODE**.□□
4. Press <MENU/OK> and <UP/DOWN> to select **ANS & REC** or **ANSWER ONLY**.□
5. Press <MENU/OK> to confirm.

9.9 TAM Messages

9.9.1 Play the TAM messages

If you have new messages, the base display will show e.g. 01/02 MSGS, which means you have 1 new message out of a total of 2 messages. New messages are played first, and then are saved as old messages, until they are deleted. Old messages are played again after all new messages are played completely.





9.9.1.1 Using the direct key

In idle:

1. Press <PLAY/STOP> to listen to messages and memos.
2. Press <PLAY/STOP> if you want to stop the playback.
3. Press <REPEAT> once if you want to repeat the current message from the beginning, or press twice to skip back to the previous message during message playback.
4. Press <SKIP> if you want to skip forward to the next message during message playback.
5. Press <DELETE> if you want to delete the current message being played.

9.9.1.2 Using the Menu

1. Press <MENU/OK> and <UP/DOWN> to select **ANS. MACHINE**.
2. Press <MENU/OK> to show **MSG PLAYBACK**.
3. Press <MENU/OK> to start playing back the messages through the speakerphone.

9.9.2 Delete a Message on the TAM

1. Press <DELETE> while a message is playing.
2. You will hear a tone and the current message or memo playing will be deleted. If there are more messages, the next message will start to play.

9.9.3 Delete All Messages on the TAM

9.9.3.1 Using the direct key

1. In idle mode, press and hold <DELETE> for 2 seconds to delete all old messages.
2. You will hear a tone and all old messages will be deleted.

Note: new messages will not be deleted.

9.9.3.2 Using the Menu

1. Press <MENU/OK> and <UP/DOWN> to select **ANS. MACHINE**.
2. Press <MENU/OK> and <UP/DOWN> to select **DELETE ALL**.
3. Press <MENU/OK> to confirm, and display will show **"CONFIRM?"**.
4. Press <MENU/OK> to reconfirm and the display will return to the previous menu.

Note: You cannot delete New Messages, so you will have to start to play them before trying to delete them.

9.10 Record a Memo on the TAM

You can record a memo message for another user. When you record a memo, it is saved as a new message and can be played back in the same way as answering machine messages. Memo recording can still function even when the answering machine is turned off.

9.10.1 Using the direct key

1. Press and hold <SKIP> and the display will briefly show MEMO, and then "**RECORDING**" and the current recording time. Release the button and start talking.
2. When you want to end your memo recording, press <PLAY/STOP>. The memo will then play back. Let it play to the end or press <MENU/OK> again to stop the playback and save the message.
OR press <DELETE> at any time to stop the memo without saving it.

9.10.2 Using the Menu

1. Press <MENU/OK> and <UP/DOWN> to select **ANS. MACHINE**.
2. Press <MENU/OK> and <UP/DOWN> to select **MEMO**.
3. Press <MENU/OK> to start recording the memo, and **RECORDING** and a timer are shown on the display.
4. Press <MENU/OK> to end your memo recording and the memo will then play back.
Let it play to the end or press <MENU/OK> again to stop the playback and save the message.

OR press <DELETE> at any time to stop the memo without saving it.

Note: If the memory becomes full, during the memo recording, you will hear a tone, the recording will stop and the memo recorded will start to play back.

9.11 Incoming Call Messages (ICM)

If the answering machine is ON and set for ANS & REC, when there is an incoming call, the answering machine will answer it and play the OGM, followed by a beep sound. The caller can then leave a message of up to 1, 2 or 3 minutes, or of unlimited length up to the available memory on the answering machine, as set in section 9.12.2. If the BS SCREENING is ON, the caller's voice will also be played through the loudspeaker on the base station, to allow you to screen the call and decide if you want to leave the answering machine to record the message, or if you want to talk to the caller directly.

At any time if you want to pick up the call, you can lift up the corded handset or press <SPEAKERPHONE> to intercept the call and talk to the caller directly. The message recording will be stopped automatically. If the answering machine is in the process of recording, the message already stored will be saved.

- You can use the corded handset, the speakerphone or the cordless handset to intercept the call to speak to the caller during ICM recording. Then the message that is currently being recorded will be saved as a new message.

9.12 TAM Settings

9.12.1 Set the Answer Delay

You can set the number of rings before the answering machine answers and starts playing your OGM. You can set the answering machine to answer after two to eight rings or **TIME SAVER**.

When you ring in to access your messages remotely, if your answering machine is set to time saver, it will answer after 2 rings if you have new messages, or after 6 rings if you do not have any new messages, so if you call in and don't get an answer within 4 or 5 rings, you can hang up and save on call charges.

1. Press <MENU/OK> and <UP/DOWN> to select **ANS. MACHINE**.
2. Press <MENU/OK> and <UP/DOWN> to select **TAM SETTINGS**.
3. Press <MENU/OK> and <UP/DOWN> to select **ANSWER DELAY**.
4. Press <MENU/OK> and <UP/DOWN> to select the desired answer delay from the available options 2 RINGS, 4 RINGS, 6 RINGS, 8 RINGS or TIME SAVER.
5. Press <MENU/OK> to confirm.

9.12.2 Set the Maximum Recording Time for Incoming Messages

You can set the maximum length of the recording time of the incoming messages to be either 1, 2 or 3 minutes, or of unlimited length up to the available memory left on the answering machine.

1. Press <MENU/OK> and <UP/DOWN> to select **ANS. MACHINE**.
2. Press <MENU/OK> and <UP/DOWN> to select **TAM SETTINGS**.
3. Press <MENU/OK> and <UP/DOWN> to select **RECORD TIME**.
4. Press <MENU/OK> and <UP/DOWN> to select your desired recording time from the available options 60S, 120S, 180S or UNLIMITED.
5. Press <MENU/OK> to confirm.



9.12.3 Set the Outgoing Message Language

The answering machine announces the outgoing message when it answers a call. There is a pre-set OGM for each of **ANS & REC** mode or **ANSWER ONLY** mode, which can be either English or French (Francais) on this model.

1. Press <MENU/OK> and <UP/DOWN> to select **ANS. MACHINE**.
2. Press <MENU/OK> and <UP/DOWN> to select **TAM SETTINGS**.
3. Press <MENU/OK> and <UP/DOWN> to select **TAM LANGUAGE**.
4. Press <MENU/OK> and <UP/DOWN> to select your desired OGM language.
5. Press <MENU/OK> to confirm.

9.12.4 Turn On or Off the Base Screening

You can select to turn on or off the call screening on the base.

1. Press <MENU/OK> and <UP/DOWN> to select **ANS. MACHINE**.
2. Press <MENU/OK> and <UP/DOWN> to select **TAM SETTINGS**.
3. Press <MENU/OK> and <UP/DOWN> to select **BS SCREENING**.
4. Press <MENU/OK> and <UP/DOWN> to select **ON** or **OFF**.
5. Press <MENU/OK> to confirm.

9.12.5 Activate Remote Access

Your phone lets you check your messages, or otherwise operate your answering machine, by calling the answering machine when you are away from home and then dialling a 4-digit remote access PIN from a tone-dialling phone, provided the Remote Access is turned on.

1. Press <MENU/OK> and <UP/DOWN> to select **ANS. MACHINE**.
2. Press <MENU/OK> and <UP/DOWN> to select **TAM SETTINGS**.
3. Press <MENU/OK> and <UP/DOWN> to select **REMOTE ACC**.
4. Press <MENU/OK> and <UP/DOWN> to select **ON** or **OFF** to turn on or off the remote access respectively.
5. Press <MENU/OK> to confirm.



9.12.6 Change the Compression Rate

Three different compression rates (**HIGH**, **MEDIUM** and **LOW**) are provided for you to select different quality levels of recording incoming message. The lower the compression rate, the higher the recording quality level attained, but the shorter the total recording time available. (LOW = 20 minutes, MEDIUM = 30 minutes, HIGH = 50 minutes approximately.)

1. Press <MENU/OK> and <UP/DOWN> to select **ANS. MACHINE**.
2. Press <MENU/OK> and <UP/DOWN> to select **TAM SETTINGS**.
3. Press <MENU/OK> and <UP/DOWN> to select **COMPRESSION**.
4. Press <MENU/OK> and <UP/DOWN> to select your desired compression rate.
5. Press <MENU/OK> to confirm.

9.12.7 Change the 4-Digit Remote Access PIN

Your phone lets you check your messages, or otherwise operate your answering machine, by calling the answering machine when you are away from home and then dialling a 4-digit remote access PIN from a tone-dialling phone.

The 4-digit remote access PIN code is used to prevent other people from unauthorised access of your answering machine.



Speakeasy Combo 3865
system

iDECT

Remote operation

- 1 **Using a tone-dialling phone, dial your home number**
- 2 **While your outgoing message is playing, press ***
- 3 **Key in your remote security code**

The default code is 0000. For details of how to set a new code, see the User Guide 9.12.7 on page 65.

Note: The <*> key can be entered during or after the OGM and the 4-digit PIN should follow without any delays. If the 4-digit Remote Access PIN is entered incorrectly three times consecutively, the line will be released automatically.

- 4 **You can also use the codes on the other side of this card**

Note: If your answering machine is switched off, the phone will enter into the remote access mode after 14 rings.

You can then enter the 4-digit remote access PIN

(Default Remote Access PIN is 0000) to activate the remote access feature.

1. Press <MENU/OK> and <UP/DOWN> to select **ANS. MACHINE.**
2. Press <MENU/OK> and <UP/DOWN> to select **TAM SETTINGS.**
3. Press <MENU/OK> and <UP/DOWN> to select **CHANGE PIN.**
4. Press <MENU/OK> to show PIN?, and enter the old PIN.
(Default Remote Access PIN is 0000).
5. Press <MENU/OK> to show NEW PIN, then enter your new 4-digit PIN.
6. Press <MENU/OK> to show REPEAT, then enter your new 4-digit PIN again.
7. Press <MENU/OK> to confirm the change.

9.12.8 Reset TAM to Default Settings

You can reset your answering machine to the default settings, without deleting any messages.

1. Press <MENU/OK> and <UP/DOWN> to select **ANS. MACHINE.**
2. Press <MENU/OK> and <UP/DOWN> to select **TAM SETTINGS.**
3. Press <MENU/OK> and <UP/DOWN> to **TAM DEFAULT.**
4. Press <MENU/OK> and the display will show **"PIN ?"**, and then enter the system PIN code. (Default is 0000)
5. Press <MENU/OK> to restore the TAM settings to default.



Keys	Functions	
	While message is not playing	While message is playing
2		Delete the current message playing.
4		Repeat playing the current message from the beginning. Press twice to skip backward to play the previous message.
5	Play the message	Stop the current message playback
6		Skip to play the next message
7	Turn on the answering machine	
8		Stop the current message playback
9	Turn off the answering machine	

10 TROUBLESHOOTING

If you have difficulty with your phone, please try the suggestions listed below.

Problem	Cause	Solutions
No dialling tone when pressing <TALK ON/SPEAKERPHONE> key	<ul style="list-style-type: none"> a. The connection cord of the base station is not plugged in. b. The adapter cord is not plugged in correctly in the base station. c. Another handset is using the base to make a call. d. Wrong telephone line cord. 	<ul style="list-style-type: none"> a. Check the connections. Unplug and plug back in the mains. Check that the telephone line cord has been plugged into the base station and the phone socket. b. Check the mains adapter is firmly plugged into the mains socket and into the base station. c. Wait until the line is unoccupied. d. Use the original line cord supplied.
When connected to a PBX, no and/or wrong connection after dialling.	Dialling prefix is needed.	Insert the dialling prefix
"SEARCHING" is displayed on cordless handset.	<ul style="list-style-type: none"> a. Base station out of range. b. Base station not connected to mains. 	<ul style="list-style-type: none"> a. Reduce the range. b. Connect base station to mains.
The call does not work.	Service not activated or wrong operator or wrong dialling mode setting.	Check your Subscription with network or change the dial mode.
<ul style="list-style-type: none"> a. No display on cordless handset. b. No display on the base. 	<ul style="list-style-type: none"> a. Empty battery b. Mains power not connected. 	<ul style="list-style-type: none"> a. Recharge cordless handset battery b. Check the mains adapter is firmly plugged into a mains socket and into the base unit.
Answering Machine		
The unit does not record new messages.	The answering machine is turned off.	Turn on the answering machine.
The caller cannot leave a message.	<ul style="list-style-type: none"> a. The answering machine is turned off. b. Message memory is full. c. Answer Only mode is set. 	<ul style="list-style-type: none"> a. Turn on the answering machine. b. Erase unnecessary messages. c. Change to Answer & Record mode.
I cannot operate the answering machine remotely.	<ul style="list-style-type: none"> a. You are entering the wrong remote access code. b. You are pressing the dial keys too quickly. c. You are using a pulse telephone. d. The remote access feature is not activated. 	<ul style="list-style-type: none"> a. If you forget the remote access code, reset to the default settings. b. Press each key firmly. c. Try again using a touch tone phone. d. Activate the remote access feature.
While recording an outgoing message or listening to messages, the unit rings and recording stops.	A call is being received.	Answer the incoming call and try again to record your outgoing message later.

This telephone is not equipped with an earth function! Therefore some of the functions may be limited when used in PBX systems.

If the fault persists:

Disconnect all other instruments connected to the same line as this, and try to make a call.

Disconnect the base unit from the telephone line and plug a different phone into the master socket. Try making a call. If this works the line is ok.

If the call does not work, and you are using a two-way socket adapter, remove it and plug the telephone directly into the socket. If the call now works, the adapter may be faulty.

If you still cannot make a call, the fault may be on the exchange line, so contact your telephone line provider.

If you still cannot identify the cause of the problem, contact the Helpline on 0845 345 9677 (UK only).

11 DECLARATION OF CONFORMITY

We the manufacturer / Importer : Binatone Telecom Plc,

Declare under our sole responsibility that the following product

Type of equipment: Digital corded + cordless telephone

Model Name: Speakeasy Combo 3865 Series

Country of Origin: China

Brand: Binatone

complies with the essential protection requirements of R&TTE Directive 1999/5/EC on the approximation of the laws of the Member States relating to *Radio Spectrum Matters*, the Council Directive 2004/108/EC on the approximation of the laws of the Member States relating to *electromagnetic compatibility (EMC)* and the European Community Directive 2006/95/EC relating to *Electrical Safety*.

Assessment of compliance of the product with the requirements relating to the essential requirements according to Article 3 R&TTE was based on Annex III of the Directive 1999/5/EC and the following standard:

Radio Spectrum: ETSI EN 301406 : V 2.1.1 (2009-07)

EMC: ETSI EN 301489-6: V1.3.1 (2008-08)

ETSI EN 301489-1: V1.8.1 (2008-04)

Safety: EN60950 -1 : 2006 + A11: 2009

Manufacturer / Importer
(signature of authorized person)

31 March 2011

Date



Signature

The conformity to the requirements is validated by the  symbol.

NOTE: *In compliance with Directive 2002/96/EC, when you purchase a product that comes with the symbol shown on the right, you are required to dispose of electrical and electronic equipment by separate waste collection and you cannot dispose of the product as normal waste.*

This equipment and all its components, subsystems and consumable materials formed an integral part of this product and when you decide to dispose of them you have to take them to a local recycling centre for appropriate waste disposal, in compliance with the current regulations.



Details about the location of these centres can be obtained from your local authority.

Notes for battery disposal

Your product contains batteries covered by the European Directive 2006/66/EC, which cannot be disposed of with normal household waste. Please be aware of the local rules on separate collection of batteries. The correct disposal of batteries helps protect the environment and prevent health hazards.



12 PRODUCT GUARANTEE

The phone system is guaranteed for 12 months from the date of purchase shown on your sales receipt. This guarantee does not cover any faults or defects caused by accidents, misuse, fair wear and tear, neglect, faults on the telephone line, lightning, tampering with the equipment, or any attempt at adjustment or repair other than through approved agents.

Please keep your sales (till) receipt this is your guarantee.

You should also keep the original packaging material.

In the unlikely event that you need to return your phone system to our Repair Centre while it is under guarantee, there may be a handling charge.

While the unit is under Guarantee

1. Disconnect the base unit from the telephone line and the mains electricity supply.
2. Pack up all parts of your Phone system , using the original packaging.
3. Return the unit to the shop where you bought it, making sure you take your sales receipt.
Remember to include the mains adapter.

After the Guarantee has expired

If the unit is no longer under Guarantee, first follow steps 1 and 2 as for repair under Guarantee. Then...

3. Call Helpline on 0845 345 9677 (for UK only) and ask for a quotation of the repair charge and details of where to send your phone system for repair.
4. Make sure you include with your phone system.
 - Your name and address
 - A cheque or postal order for the value of the repair
 - A brief description of the fault.
5. Return your phone system to the address given by the Service Department.

* *This does not affect your statutory rights.*

