

Register your product and get support at
www.philips.com/welcome

PicoPix

PPX2450

PPX2480



EN User Manual

PHILIPS

Table of Contents

Overview	3
Dear Customer	3
About this User Manual	3
1 General Safety Information	4
Setting Up the Device	4
Repairs	4
Power Supply	4
2 Overview.....	6
Top of the Device	6
Side view	6
Bottom of the Device	6
Remote Control	7
Overview of the Menu Functions	8
3 Initial Operation	9
Setting up the Device	9
Connecting power supply / Charging battery	9
Initial Installation	9
Installing or Changing the Batteries of the Remote Control	10
Using the Remote Control	11
4 Connect to the playback device	12
Connecting to Devices with HDMI output	12
Connecting to a Computer (VGA)	12
Connecting using Audio/Video (CVBS) Adaptor Cable	13
Connecting using Component-Video (YPbPr/YUV) Cable	13
Connecting the headphones	14
5 Memory card / USB storage medium	15
Inserting a Memory Card	15
Connecting USB Storage Medium	15
6 Media Playback.....	16
Video Playback	16
Photo Playback	17
Music Playback	18
Managing files	18
7 Settings	21
8 Service.....	23
Care Instructions for the Battery	23
Cleaning	23
Troubleshooting	24
9 Appendix.....	25
Technical Data	25
Accessories	25

Overview

Dear Customer

Thank you for purchasing our Pocket Projector.
We hope you enjoy your device and its many functions!

About this User Manual

With the installation guide on the following pages, you can start using your device quickly and easily. Detailed descriptions can be found in the following sections of this user manual.

Read the entire user manual carefully. Follow all safety instructions in order to ensure proper operation of your device. The manufacturer accepts no liability if these instructions are not followed.

Symbols Used

Note



Troubleshooting

This symbol designates tips that will help you to use your device more effectively and easily.

CAUTION!



Damage to the Device or Loss of Data!

This symbol gives warning of damage to the device and possible loss of data. These damages can result from improper handling.

DANGER!



Danger to Persons!

This symbol gives warning of danger to persons. Physical injury or damage can result from improper handling.

I General Safety Information

Do not make any changes or settings that are not described in this user manual. Physical injury or damage to the device or loss of data can result from improper handling. Take note of all warning and safety notes indicated.

Setting Up the Device

The device is exclusively for indoor use. The device should be placed securely on a stable, flat surface. Position all cables in such a way that no one will stumble on them, thus avoiding possible injuries to persons or damage to the device itself.

Do not plug in the device in moist rooms. Never touch the mains cable or the mains connection with wet hands.

The device must have sufficient ventilation and may not be covered. Do not put your device in closed cabinets or boxes.

Do not place the machine on soft surfaces such as tablecloths or carpets and do not cover the ventilation slits. Otherwise the device could overheat or catch fire.

Protect the device against direct sunlight, heat, large temperature fluctuations and moisture. Do not place the device in the vicinity of heaters or air conditioners. Observe the information on temperature and humidity in the technical data.

When the device is running for a long period of time, the surface becomes hot and a warning symbol appears on the projection. The device switches automatically to stand-by mode when it gets too hot. After the device has cooled down, you can continue playback by pressing any key.

Do not allow liquids to enter into the device. Switch off the device and disconnect it from the mains supply if liquids or foreign substances end up inside the device. Have the unit inspected by a technical service department.

Always handle the unit with care. Avoid touching the lens. Never place heavy or sharp objects on the projector or the power cable.

If the projector gets too hot or emits smoke, shut it down immediately and unplug the power cable. Have your device examined by trained professionals at a technical service location. To prevent the spread of fire, open flames should be kept away from the device.

Under the following conditions, a layer of moisture can appear inside the device which can lead to malfunctions:

- if the device is moved from a cold to a warm area;
- after a cold room is heated;
- when this device is placed in a damp room.

Proceed as follows to avoid any moisture build-up:

1 Seal this device in a plastic bag before moving it to another room, in order for it to adapt to room conditions.

2 Wait one to two hours before you take the device out of the plastic bag.

The device should not be used in a very dusty environment. Dust particles and other foreign objects may damage the unit.

Do not expose the device to extreme vibrations. It may damage the internal components.

Do not allow children to handle the device without supervision. The packing materials should be kept out of the hands of children.

Repairs

Do not make any repairs to the device yourself. Improper maintenance can result in injuries or damage to the device. Only have your device repaired by an authorised service centre.

Do not remove the type label from your device; this would void the warranty.

Power Supply

Use only the enclosed power adapter (see chapter Appendix / Technical Data). Check whether the mains voltage of the power supply matches the mains voltage available at the setup location. This equipment complies with the voltage type specified on the unit.

The capacity of the battery diminishes with time. If the device functions only with the power supply, the battery is defective. Contact an authorised service centre to replace the battery.

Do not try to replace the battery yourself. Incorrect handling of the battery or using the wrong type of battery can cause damage to the device or cause injury.

DANGER!



Risk of explosion with incorrect type of batteries

Only replace the batteries with the same or comparable batteries.

There is a risk of explosion if the incorrect battery type is used.

Switch the device on or off using the power switch before removing the power supply from the socket.

Turn off the device and remove it from the power supply before cleaning the surface. Use a soft, lint-free cloth. Never use liquid, gaseous or easily flammable cleansers (sprays, abrasives, polishes, alcohol). Do not allow any moisture to reach the interior of the device.

DANGER!



High Power LED

This device is equipped with an high power LED (Light Emitting Diode), which emits very bright light. Do not look directly into the projector lens. This could cause eye irritation or damage.

DANGER!



Danger of Hearing Damage

Do not use the device over a longer time at high volume—especially when using headphones. This could lead to the risks of hearing damage.

2 Overview

Top of the Device

①—Focus wheel for image sharpness.

Note



Note that the distance to the projection surface must be a minimum of 0.5 meters and a maximum of 5 meters. If the Pocket Projector is located outside of this range, it will not be possible to focus the image. Turn the focus wheel carefully so as to avoid damaging the lens.

② —One menu step back, one directory level back / cancelling a function

③—Navigation key / OK key

Ⓞ—Confirm entry / start, stop video/music playback or slideshow.

⬆️/⬆️—Navigating / during music playback select previous, next title when image display is switched off

⬅️/⬆️—Navigating / during music playback: adjust volume level / during video playback review, cue

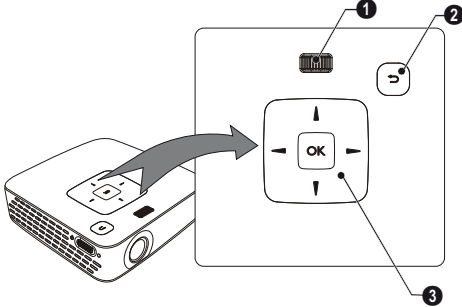

Side view

① **ON/OFF**—On/Off switch

②—Battery status monitor

red: battery empty

Charge indicator with connected power supply:

red: Charging battery

Green: battery is fully charged

③—Remote-control signal receiver

④ —Audio output – headphone connection or connection for external speakers

⑤ **HDMI**—Connection for a playback device with an HDMI output via an adapter cable

⑥ **SD/MMC**—Memory card slot (SD/SDHC/MMC)

⑦ —USB connection for a computer (data exchange) or for a USB storage medium (with the enclosed adapter cable)

⑧ **DC IN**—Port for power supply

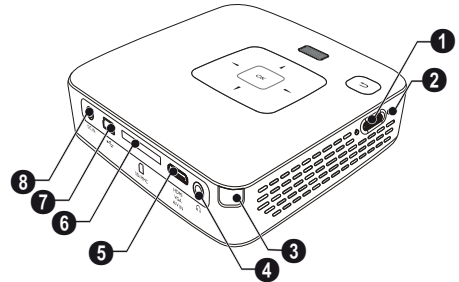

Bottom of the Device

① Tripod socket

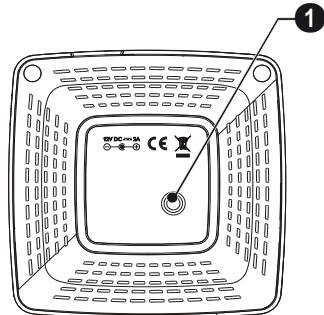

Remote Control

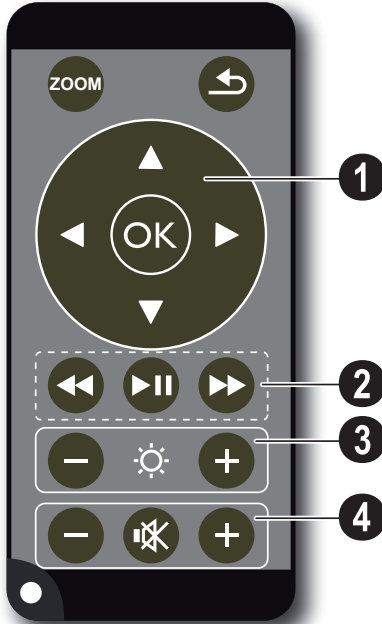

—Magnify still. Pan using the navigation keys (, , ,)

—One menu step back, one directory level back / cancelling a function

1 Direction Buttons

—Confirms selection

, , , —Navigation keys / navigate the menu / modify settings

, —Modify settings / during music playback select previous, next title

, —During music playback adjust volume level / during video playback review, cue

2 Playback keys

—During video playback review

—Start / stop playback

—During video playback cue

3 Brightness keys

—Decrease / increase the brightness

4 Volume keys

—Decrease the volume

—Deactivate sound

—Increase the volume

Overview of the Menu Functions

- 1 After switching on the device the main menu appears.
- 2 Select the desired menu using the navigation keys (▲/▼, ◀/▶).
- 3 Confirm with (OK).
- 4 By pressing the (⏪) key several times you will return to the main menu.

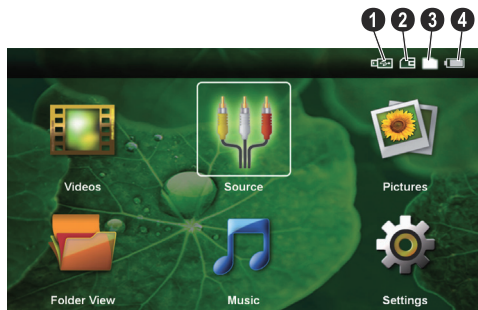

Videos—Selecting files for video playback

Source—Switch to the external video input **HDMI, AV, COMPONENT** or **VGA**

Pictures—Selecting files for the slideshow

Folder View—Selecting files for Playback. Copy or Delete Files (Mark the files with (▶) and confirm using (OK)).

Music—Selecting music files for playback

Settings—Configure settings for playback and for the device

Symbols in the Main Menu

The chosen storage appears highlighted in white.

- 1—USB storage medium
- 2—Memory card
- 3—Internal memory
- 4—Charge level of the internal battery The icon will flash red, when the battery needs to be recharged. If the power supply is connected, no symbol is displayed.

3 Initial Operation

Setting up the Device

You can position the device so that it lies flat on a table in front of the projection surface; it is not necessary to tilt it towards the projection surface. The device compensates for the distortion from the slanted projection (pincushion distortion).

A tripod accessory is available if you want to elevate the device.

Connecting power supply / Charging battery

CAUTION!



Mains Voltage at the Site of Installation!

Check whether the mains voltage of the power supply matches the mains voltage available at the setup location.

- 1 Insert the small plug of the power supply into the socket on the rear side of your device.
- 2 Plug the power supply into the mains.
- 3 During the charging process, the indicator light on the side of the device will be red. When the battery is fully charged, it will turn green.
- 4 Charge the built-in battery before using for the first time for at least 3 hours. This will prolong the life of the battery.

AC 100~240V

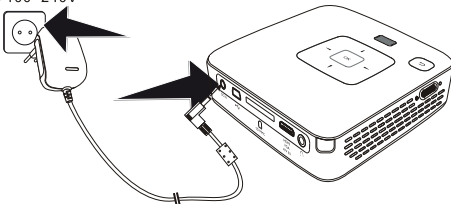

Initial Installation

- 1 Switch the device on using the on/off switch on the side.
- 2 Turn the device towards a suitable projection surface or wall. Note that the distance to the projection surface must be a minimum of 0.5 meters and a maximum of 5 meters. Make sure the projector is in a secure position.
- 3 Use the focus wheel on the top to adjust the image sharpness.
- 4 Select the desired menu language using $\blacktriangle/\blacktriangledown$.
- 5 Confirm with OK .

Note



The main menu appears instead of the language selection

The device has already been installed. In order to change the menu language, proceed as follows:

- 1 Use the navigation keys to select **Settings**.
- 2 Confirm with OK .
- 3 Select with $\blacktriangle/\blacktriangledown$ **Language**.
- 4 Confirm with OK .
- 5 Select the desired language with $\blacktriangle/\blacktriangledown$.
- 6 Confirm with OK .
- 7 Exit with Exit .

Installing or Changing the Batteries of the Remote Control

DANGER!



Risk of explosion with incorrect type of batteries

Only use the CR 2025 type battery.

There is a risk of explosion if the incorrect battery type is used.

- 1 To access the battery, disengage the locking mechanism (1) and slide out the battery compartment (2).



- 2 Insert the new batteries into the battery compartment with the positive and negative poles as shown on the back of the remote control. Make sure the polarities (+ and -) are aligned correctly.



- 3 Push the battery compartment back into the remote control until the locking mechanism engages.



Note



Normally the batteries will last for around one year. If the remote control stops working, please replace the batteries. If the device is not used for a long time, take out the batteries. This will prevent leakage and possible damage to the remote control.

The used batteries should be disposed of according to the recycling regulations of your country.

Using the Remote Control

Point the remote control at the remote sensor on the back of the device. The remote can be used within an angle of 60 degrees and up to 3 meters from the device. When using the remote control, no obstacle should be placed between the remote control and remote sensor.

CAUTION!



- The improper use of batteries can lead to overheating, explosion, risk of fire and injury. Leaking batteries can possibly damage the remote control.
- Never expose the remote control to direct sunlight.
- Avoid deforming, dismantling or charging the batteries.
- Avoid exposure to open fire and water.
- Replace empty batteries immediately.
- Remove the battery from the remote control if not in use for long period of time.

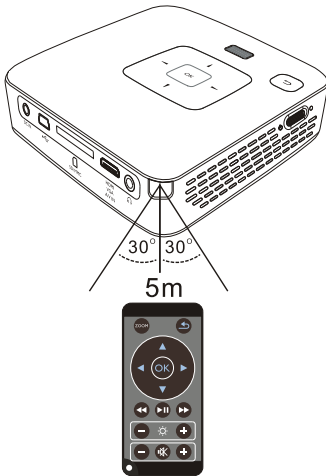

4 Connect to the playback device

Only use the supplied cable or cables that are available as accessories to connect the projector.

Supplied Cables

Video-(CVBS) cable

USB Adaptercable to connect an USB storage medium

Cables available as Accessories

Component Video Cable YUV /YPbPr

.....(PPA 1210 / 253447083)

VGA-Audio Cable(PPA 1250 / 253447070)

iPod / iPhone /iPad Cable

.....(PPA 1280 / 253447091)

Connecting to Devices with HDMI output

Use the HDMI to mini HDMI cable (not included) to connect the projector to a computer or laptop.

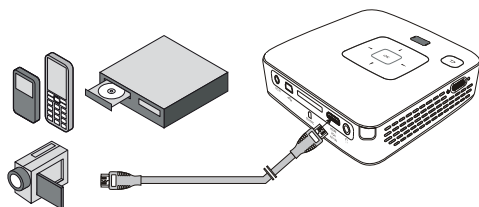

- 1 Switch to **HDMI** in **Menu > Source**
- 2 Connect the HDMI cable to the projector's mini-HDMI socket.
- 3 Connect the cable to the HDMI socket of the playback device.

Connecting to a Computer (VGA)

Note



Many laptops do not activate the external video output automatically when you connect a second display such as a projector. Check your laptop's manual to find out how to activate the external video output.

Use the VGA-Audio cable (PPX2480 included, PPX2450 accessory) to connect the projector to a computer, laptop, or some PDAs. The projector supports the following resolutions: VGA/SVGA/XGA. For best results, set the computer's resolution to SVGA (800x600).

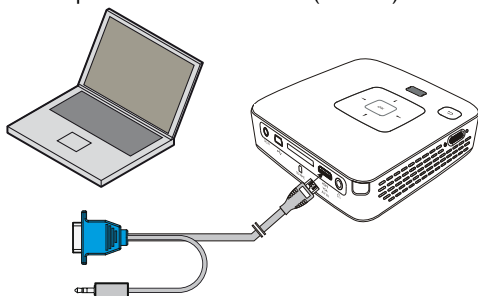

- 1 Connect the VGA-Audio cable to the projector's mini-HDMI socket.
- 2 Connect the VGA plug to the computer's VGA socket and the audio plug to the computer's audio output.
- 3 Adjust the computer's resolution to the correct setting and switch the VGA signal to an external monitor. The following resolutions are supported:

	Resolution	Image refresh rate
VGA	640 x 480	60 Hz
SVGA	800 x 600	60 Hz
XGA	1024 x 768	60 Hz

Note



Screen Resolution

You can obtain the best results with the 800 x 600 (60Hz) resolution.

- 4 Select **Menu > Source** and switch to **VGA**.

Connecting using Audio/Video (CVBS) Adaptor Cable

Use the projector's audio/video adaptor cable (A/V cable) to connect camcorders, DVD players or digital cameras. The jacks for these devices are yellow (video), red (audio right) and white (audio left).

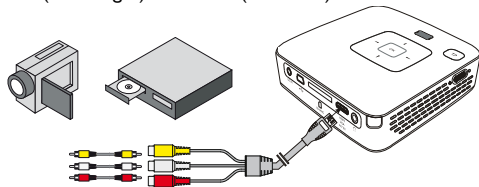

- 1 Connect the supplied A/V cable to the projector's mini-HDMI socket.
- 2 Connect the video device's audio/video jacks to the A/V cable using a conventional composite video (RCA) cable.
- 3 Select **Menu > Source** and switch to **AV**.

Connecting to mobile multimedia devices

Some video devices (e.g.: pocket multimedia players, ...) require specific connection cables. There are either supplied with the device or acquired from the manufacturer of the multimedia device. Please note that only the original cables from the device manufacturer may function.

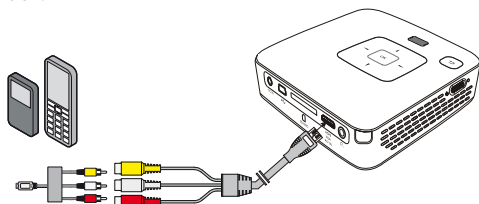

Note



Switching to the multimedia device signal output

See the multimedia device instruction manual to find out how to switch the signal output to this jack.

Connecting using Component-Video (YPbPr/ YUV) Cable

Please use this type of connection to obtain the highest possible image quality. This cable is available as an accessory. The device jacks have the colours green (Y), blue (U/Pb), red (V/Pr) for the video signal and red (audio right) and white (audio left) for the audio signal.

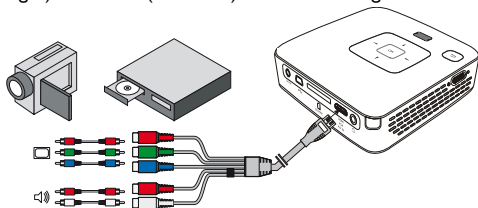

- 1 Connect the video component cable (accessory) to the projector's mini-HDMI socket.
- 2 Connect the video device's appropriate colored sockets to the component video cable of the projector using a conventional component video (RCA) cable.

Note



YCbCr

Note that the **YPbPr** outlets are labelled **YCbCr** on some devices.

Note



Two red phono (RCA) connectors

When connecting, note that there are two red phono (RCA) connectors on the cable. One is for the right audio signal and the other for the V/Pr element of the component video signal. If these two connectors are inserted incorrectly, the projected image appears green and the audio signal for the right speaker will not work.

- 3 Select **Menu > Source** and switch to **Component**.

Connecting to mobile multimedia devices

Some video devices (e.g.: pocket multimedia players, ...) require specific connection cables. There are either supplied with the device or acquired from the manufacturer of the multimedia device. Please note that only the original cables from the device manufacturer may function.

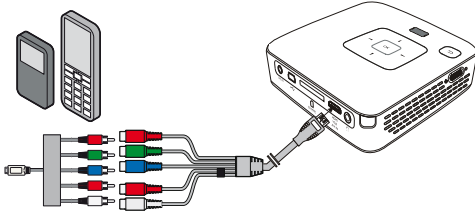

Note



Switching to the multimedia device signal output

See the multimedia device instruction manual to find out how to switch the signal output to this jack.

Connecting the headphones

- 1 Before connecting the headphones, turn down the volume on the device.
- 2 Connect the headphones to the projector's headphone slot. The device speakers deactivate automatically when the headphones are connected.

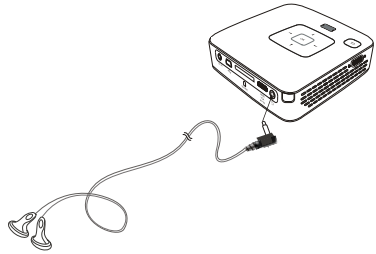

- 3 After connecting the headphones, increase the volume to a comfortable level.

DANGER!



Danger of Hearing Damage

Do not use the device over a longer time at high volume—especially when using headphones. This could lead to the risks of hearing damage. Before connecting the headphones, turn down the volume on the device. After connecting the headphones, increase the volume to a comfortable level.

5 Memory card / USB storage medium

Inserting a Memory Card

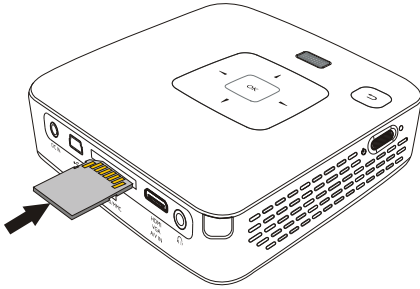

- 1 Insert a memory card with the contacts facing upwards into the **SD/MMC** slot at the back of the device. Your device supports the following memory cards: SD/SDHC/MMC.
- 2 Insert the memory card into the slot until it snaps into position.

DANGER!



Inserting a Memory Card!

Never pull out the memory card while the device is accessing it. This could cause data to be damaged or lost.

In order to make sure that the device does not access the memory card, press the  key in the main menu until the symbol for the internal memory has been selected.

- 3 Press lightly on the memory card to remove it.
- 4 The memory card is ejected.

Connecting USB Storage Medium

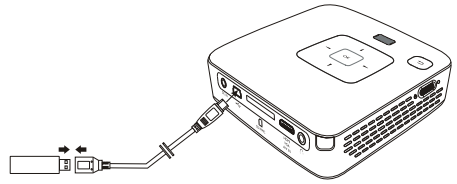

- 1 Connect the USB adapter cable provided to the mini-USB socket on the reverse side of the device.
- 2 Only connect the USB storage medium to the adapter cable **after** the adapter cable has been connected to the device.

Note



USB storage medium with mini-USB connector

Ensure that the adapter cable is connected to the projector and not to the USB storage medium. The signal is switched correctly between the computer connection and the USB storage medium only when using the adapter cable.

6 Media Playback

Note



Navigation keys

All the keys shown are buttons on the remote control.

Video Playback

Video Playback (USB/SD card/ internal memory)

- 1 Switch the device on using the on/off switch on the side.
- 2 After the initial screen the main menu appears.

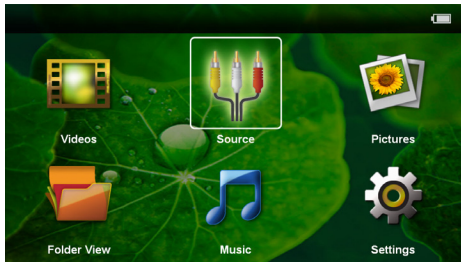

- 3 Use the navigation keys to select **Videos**.
- 4 Confirm with **OK**.
- 5 **With an inserted memory card or USB storage device:** Select the internal memory, the USB storage medium or the memory card using the keys **▲/▼**.
- 6 Confirm with **OK**.
- 7 Use **▲/▼** to select the video file that you wish to play.



Note



Displaying video files

Only those videos that are compatible with the Pocket Projector will be displayed.

- 8 Press **OK** to start playback.

- 9 Press **⏪** to end playback and return to the overview.
- 10 When you press **⏩** again, you will return to the main menu.

Note



Navigation during playback

Review / cue: Press **⏮/⏭** on the remote control or **⏮/⏭** on the device.

Press **⏸** to stop or continue playback.

During playback you can adjust the volume using **⏮/⏭** on the remote control. Press **⊗** or **⊖** repeatedly to shut off the volume completely.

File Format

There are various video file formats as *.mov, *.avi, *.m4v. Many of these formats function as a container that contains the various encoded audio and video files. MPEG-4, H.264, MP3, and AAC are all examples of encoded audio/video files. In order to play these files, the projector must read them and decode the audio/video signals.

Please note that some files cannot be played as a result of different video and audio encoders.

Supported File Formats

Container	Video Format
*.avi, *.mov, *.mp4	MJPEG, MPEG-4, H.264
*.mkv	MPEG-4, H.264
*.ts	MPEG-2, H.264
*.m2ts	H.264
*.3gp	H.263
*.flv	FLV (up to 800x600)
*.asf	ASF
*.rm, *.rmvb	Real video
*.dat	MPEG-1
*.vob	MPEG-2
*.mpg, *.mpeg	MPEG-1, MPEG-2

Video Playback (Mini-HDMI socket)

- 1 Connect the audio/video output of the external device to the Pocket Projector's mini-HDMI socket. Use the corresponding cable and cable adapter for this purpose (see also chapter Connect to the playback device, page 12).
- 2 To find out how to deactivate the video output for the external device, please see the relevant instruction manual. Most often, this option is labeled "TV out" or "TV Output" in the corresponding menu.
- 3 Start the video playback on the external device.
- 4 Modify the volume with \ominus/\oplus .

Modify settings during playback

- 1 Press the \uparrow or \downarrow key.
- 2 Use the \uparrow/\downarrow keys to choose from the following settings:
 - Brightness:** Adjust brightness
 - Contrast:** Adjust contrast
 - Saturation:** Adjust colour saturation
 - Smart Settings:** Select predefined settings for brightness / contrast / colour saturation
 - Volume:** Adjust volume level
- 3 Modify the setting using \leftarrow/\rightarrow .

The device saves the modified settings automatically.

Modify other settings

- 1 Press the OK button.
- 2 Use the \uparrow/\downarrow keys to choose from the following settings:
 - Image Settings:** Adjust brightness, contrast, colour saturation
 - Sound Settings:** Adjust treble, bass and volume
 - Power Save:** This function reduces the light output in order to increase the operating time for the built-in battery.
- 3 Confirm with OK .
- 4 Modify the setting using OK and \uparrow/\downarrow .
- 5 Confirm with OK .

Photo Playback

- 1 Switch the device on using the on/off switch on the side.
- 2 After the initial screen the main menu appears.

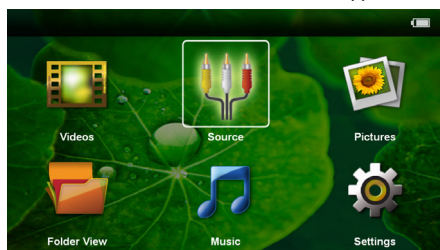

- 3 Use the navigation keys to select **Pictures**.
- 4 Confirm with OK .
- 5 **With an inserted memory card or USB storage device:** Select the internal memory, the USB storage medium or the memory card using the keys \uparrow/\downarrow .
- 6 Confirm with OK .
- 7 Miniature photos are displayed on the screen as an overview.



Note



Miniature view or list

In the settings, you are able to select whether the overview will be displayed as miniatures or in a list.

Note



Many photos on the memory card or the USB medium

If there are a lot of photos on the memory card or the USB storage medium it can take a moment before the overview appears.

- 8 Use \leftarrow/\rightarrow or \uparrow/\downarrow to select the image that you want to start the slide show with.
- 9 Press OK to start the slide show.

Note



Zoom in / Zoom out

You can enlarge the displayed image during the slide show using the zoom key. Use the $\leftarrow/\rightarrow/\uparrow/\downarrow$ keys to move around the magnified image.

- 10 Press stop to pause the slide show.
- 11 Press end to end the slide show and return to the overview.
- 12 When you press end again, you will return to the main menu.

Music Playback

Note



Switch off the image playback

You can turn off image playback while playing music in order to save power (see also chapter Music Settings, page 21). As soon as you press the key, the image reappears and the fan starts again.

- 1 Switch the device on using the on/off switch on the side.
- 2 After the initial screen the main menu appears.

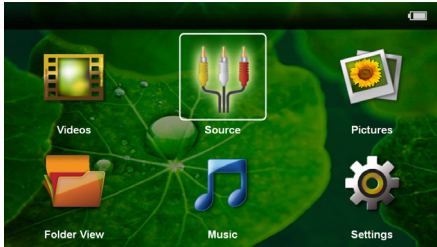

- 3 Use the navigation keys to select **Music**.
- 4 Confirm with .
- 5 **With an inserted memory card or USB storage device:** Select the internal memory, the USB storage medium or the memory card using the keys /.
- 6 Confirm with .
- 7 Use / to select the file that you wish to play.

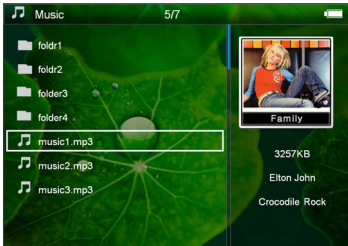

- 8 Press to start playback.
- 9 Press to stop or continue playback.

Note



Navigating when image playback is switched off

- Press / to skip to the previous or next song.
- Press to stop or continue playback.
- Press to return to the selection.

During playback you can adjust the volume using / on the remote control. Press or repeatedly to shut off the volume completely.

Managing files

Copy Files

You can copy files back and forth from the internal memory to the connected USB storage medium or memory card.

- 1 Switch the device on using the on/off switch on the side.
- 2 After the initial screen the main menu appears.



- 3 Use the navigation keys to select **Folder View**.
- 4 Confirm with .
- 5 **With an inserted memory card or USB storage device:** Select the internal memory, the USB storage medium or the memory card using the keys /.
- 6 Confirm with .
- 7 Use / to select the file that you want to copy.

Note



No Files Found (0 files)

Only those files that are compatible with the Projector will be displayed.

- 8 Mark the file using . Pressing the key again deselects the chose file(s).

Note



Mark the entire folder

You can also mark an entire folder to copy all files from the folder. Note that the copy process of large folders can takes some time.

- 9 Use / to select other files.
- 10 Press .

- 11 Select with **(▲)/(▼) Copy**.

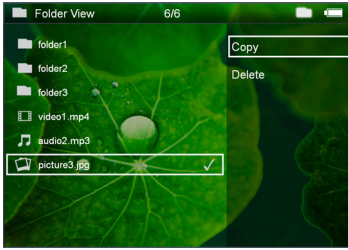

- 12 Confirm with **(OK)**.
13 Use **(▲)/(▼)** to select the destination memory: **SD card, internal memory or USB storage medium**.
14 Confirm with **(OK)**.

Note



Files already exist

If the files you are copying already exist in the target folder, you must choose whether or not you want to overwrite them using **(▲)/(▼)** and **(OK)**. If you choose not to overwrite these files, copies will be created. The copies can be recognised by a number added to the file names.

- 15 The files are copied.

Note



Error

If errors occur during the copying process, make sure that enough free space is available on the medium.

Note



Removing storage medium

Only remove the storage medium after the copy process is complete.

Delete Files

You can delete files from the internal memory, the connected USB storage medium or the memory card.

- 1 Switch the device on using the on/off switch on the side.
2 After the initial screen the main menu appears.



- 3 Use the navigation keys to select **Folder View**.
4 Confirm with **(OK)**.
5 **With an inserted memory card or USB storage device:** Select the internal memory, the USB storage medium or the memory card using the keys **(▲)/(▼)**.
6 Confirm with **(OK)**.
7 Use **(▲)/(▼)** to select the file that you want to delete.

Note



No Files Found (0 files)

Only those files that are compatible with the Projector will be displayed.

- 8 Mark the file using **(▶)**. Pressing the key again deselects the chose file(s).
9 Use **(▲)/(▼)** to select other files.
10 Press **(OK)**.
11 Select with **(▲)/(▼) Delete**.
12 Confirm with **(OK)**.
13 Use **(▲)/(▼)** if you want to delete the files or cancel the deletion process.



- 14 Confirm with **(OK)**.

Note



Error

If errors occur during the deletion process, make sure that the storage medium is not write-protected.

Note



Deleting photos on the memory card

When deleting photos via the computer, note that the photos may not be correctly displayed when the memory card is inserted into the digital camera again. Digital cameras sometimes store additional information in specific folders, including previews and orientation information.

For this reason, only delete the photos using the digital camera.

Connect to a Computer (USB)

You can use the USB cable to connect the Pocket Project to a computer. In this way, you are able to copy files back and forth between the internal memory, an inserted memory card and the computer. You can also delete the files. You can playback the files saved on the Pocket Projector on your computer.

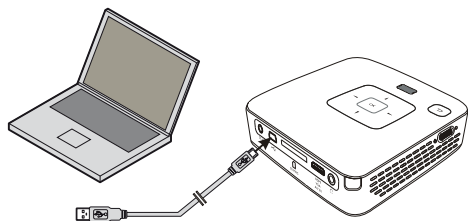

- 1 Connect the mini-USB socket to the Pocket Projector and the USB socket to the computer.
- 2 Switch the device on using the on/off switch on the side.
- 3 A confirmation appears when the devices are connected successfully.

Note



Successful connection

You cannot use the Pocket Projector when it is connected to a computer via USB.

- 4 If a memory card has been inserted, it will be displayed as another disk drive.
- 5 You can move, copy or delete data from the computer, the memory card (if inserted) and the internal memory.

7 Settings

- 1 Switch the device on using the on/off switch on the side.
- 2 After the initial screen the main menu appears.

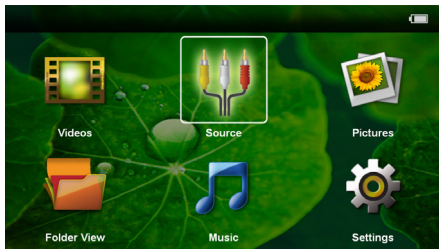

- 3 Use the navigation keys to select **Settings**.
- 4 Confirm with **OK**.
- 5 Use **▲/▼** to select from the following settings.

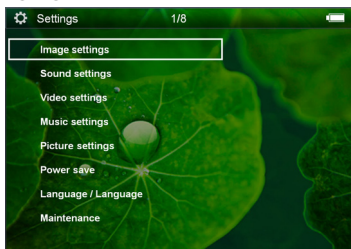

- 6 Confirm with **OK**.
- 7 Modify the settings using **OK**, **▲/▼**.
- 8 Confirm with **OK**.

The **⊖** key takes you one step back in the menu.

Image settings

Wall paper—Select background images

Fit Screen—Convert videos and images to 16:9 resolution

Projection mode

Front—Normal projection; the device is located in front of the projection surface/screen.

Rear—Rear projection; the device is located behind the projection surface; the image is horizontal mirrored.

Ceiling—The device is hanging from the ceiling in an upside-down position; the image is rotated by 180 degrees.

Rear ceiling—The device is hanging from the ceiling in an upside-down position behind the projection surface; the image is rotated by 180 degrees and horizontal mirrored.

Wall color correction—Colour correction of the projected image to adjust to coloured projection surfaces

Smart Settings—Select predefined settings for brightness / contrast / colour saturation. If you modify these settings, the setting is switched to **Manual**.

Brightness—Adjust brightness

Contrast—Adjust contrast

Saturation—Adjust colour saturation

Sound Settings:

Volume—Adjust the volume

Bass—Set the playback of the low frequencies

Treble—Set the playback of the high frequencies

Key tones—Turn key tones on and off

Video Settings

View—Display all videos in a list or a corresponding folder structure on the drive.

Repeat—Set the repeat type for video files: Repeat deactivated (**Off**), repeat all videos in a directory (**Directory**), repeat only the current video (**Movie**), repeat all videos (**All**).

Resume play—If this function is activated, playback will continue at the position it was last stopped. If deactivated, playback will always start at the beginning of the video.

Music Settings

View—Show all songs in a list or a corresponding folder structure on the drive.

Screen—Activate or deactivate the projection during playback.

Repeat—Set the repeat type for music files: Repeat deactivated (**Off**), repeat all songs in a directory (**Directory**), repeat only the current song (**Song**), repeat all songs (**All**).

Shuffle—Activate this function for random playback. Otherwise, playback will take place in sequence.

Picture Settings

View—Display the images as a **thumbnail** or as a **list** during selection in the main menu.

Time per slide—Image viewing time during slide show

Repeat—Set the type of repeat for slide show photos: Repeat off (**Off**), repeat all photos in the directory (**Directory**), repeat all stored photos (**All**).

Slide transition—Set image transitions

Slideshow order—Play slide show in order or randomly

Power Save

Eco mode—This function reduces the light output in order to increase the operating time for the built-in battery. When operating from the power supply, the energy saving mode is always deactivated in order to ensure the best-possible image display.

Sleep mode—With this function, the projector automatically shuts down after a specified period of time or at the end of a movie.

Language

Select the desired language for the menu.

Maintenance

Reset settings—Reset settings to factory defaults.

Firmware Update—Update Firmware

Note



Connect for the duration of the firmware update the power adapter.

Information—Display free space in the internal memory and information on the device (Capacity: / Free space: / Firmware Version / Device name: / Model / Mcu Version)

8 Service

Care Instructions for the Battery

The capacity of the battery diminishes with time. You can prolong the life of the battery if you observe the following points:

- Without a power supply, the device operates from the built-in battery. When the battery does not have sufficient capacity, the device switches to stand-by mode. Connect the device to the power supply.
- When the battery does not have sufficient capacity, the battery symbol in the display blinks and the battery status light on the side of the device turns red.
- When the device is running for a long period of time, the surface becomes hot and a warning symbol appears on the projection. The device switches automatically to stand-by mode when it gets too hot. After the device has cooled down, you can continue playback by pressing any key.
- Use the device at least once a week.
- Charge the battery regularly. Don't store the device with a completely discharged battery.
- If the device is not used for several weeks, discharge the battery a little by using the device before storing it.
- If the device only works using the USB connection or with the power supply, the battery is defective.
- Keep the device and the battery away from sources of heat.

DANGER!



Do not replace the battery yourself

Do not try to replace the battery yourself. Incorrect handling of the battery or using the wrong type of battery can cause damage to the device or cause injury.

Cleaning

DANGER!



Switching off the device!

Switch the device on or off using the power switch before removing the power supply from the socket.

DANGER!



Instructions for Cleaning!

Use a soft, lint-free cloth. Never use liquid or easily flammable cleansers (sprays, abrasives, polishes, alcohol, etc.). Do not allow any moisture to reach the interior of the device. Do not spray the device with any cleaning fluids.

Wipe over the surfaces gently. Be careful that you do not scratch the surfaces.

Cleaning the Lens

Use a brush or lens cleaning paper for cleaning the lens of the projector.

DANGER!



Do not use any liquid cleaning agents

Do not use any liquid cleaning agents for cleaning the lens, to avoid damaging the coating film on the lens.

Troubleshooting

Power Cycling

If a problem occurs that cannot be corrected with the instructions in this user manual (see also the help below), follow the steps given here.

- 1 Switch the device off using the on/off switch on the side.
- 2 Wait at least ten seconds.
- 3 Switch the device on using the on/off switch on the side.
- 4 If the problem repeats, please contact our technical customer service or your retailer.

Problems	Solutions
The Pocket Projector cannot be switched on	<ul style="list-style-type: none">• Connect the supplied power supply to recharge the internal battery.
No sound	<ul style="list-style-type: none">• Adjust the volume using the \oplus / \ominus key on the remote control.
No sound from the external connected device	<ul style="list-style-type: none">• Check the cables to the external device• Set the volume on the external device• Only the original cables from the device manufacturer may function
Bad sound quality with your computer connection	<ul style="list-style-type: none">• Check if the audio cable is connected to the computers headphone socket or the line-out socket.• The volume setting on the computer should not be too high.
Only the initial screen appears and not the image from the external device	<ul style="list-style-type: none">• Check if the cables are connected to the right sockets.• Please check that the external device is switched on• Check if the video output of the external device is switched on.
Only the initial screen appears and not the image from the connected computer	<ul style="list-style-type: none">• Please check that the VGA-output of the computer is switched on.• Check if the resolution of the computer is set to 800x600.
Device switches to stand-by mode	<ul style="list-style-type: none">• When the device is running for a long period of time, the surface becomes hot and a warning symbol appears on the projection. The device switches automatically to stand-by mode when it gets too hot. After the device has cooled down, you can continue playback by pressing any key.• When the battery does not have sufficient capacity, the device switches to stand-by mode. Connect the device to the power supply.

9 Appendix

Technical Data

Dimensions (L × H × W).....	105 × 31 × 105 mm
Weight.....	0.27 kg
Recommended Ambient.....	5–35 °C
Relative Humidity.....	20–80% (non-condensing)
File format.....	*.mp4, *.avi, *.mov, *.mkv,*.dat, *.mpg, *.mpeg, *.vob, *.ts*.m2ts, *.rm, *.rmvb, *.asf, *.flv, *.3gp
Photo formats.....	JPEG, BMP, PNG, GIF, TIFF
Music formats.....	MP3, WAV, WMA, OGG, AAC
Video Standard (CVBS).....	PAL, SECAM, NTSC, HD
Video Standard (YPbPr)....	480i/p, 576i/p, 720p, 1080i/p
Video connection.....	Mini-HDMI socket
Headphone connection.....	Mono - jack plug: 3,5 mm
Audio Output.....	1 W
Internal memory.....	2 GB
Compatible Memory Cards.....	SD/SDHC/MMC

Technology / Optical

Display technology.....	WVGA 0,3" DLP
Light source.....	RGB LED
Resolution.....	854 × 480 Pixel (16:9)800 × 600 Pixel (4:3)
Supported Resolutions.....	VGA/SVGA/WVGAXGA/WXGA
Brightness (Bright Mode)....	up to 80 lumen (PPX2480)up to 55 lumen (PPX2450)
Contrast ratio.....	1000:1
Projected image size.....	12–120 inch
Screen distance.....	0,5 m up to 5 m
Horizontal Scan Rate.....	31–69 kHz
Vertical Scan Rate.....	56–85 Hz

Power supply

Model No.....	MPA-630
Manufacturer.....	Wanlida Group Co., Ltd.

Built-in rechargeable battery

Battery type.....	LiPol
Capacity.....	1800mAh 7.4V
Charging time.....	3 h
Operating time.....	1 h
Operating time (ECO mode switched on).....	2 h
Manufacturer.....	Great Power

Accessories

Following accessories are available for your device:

YUV /YPbPr Adapter Cable.....	PPA 1210 / 253447083
VGA-Audio Cable.....	PPA 1250 / 253447070
iPod / iPhone /iPad cable.....	PPA 1280 / 253447091

All data are provided for reference purposes only.
Sagemcom reserves the right to make any changes without prior notice.



The CE marking certifies that the product meets the main requirements of the European Parliament and Council directives 2006/95/CE, 2004/108/CE and 2009/125/CE on telecommunications terminal equipment, regarding safety and health of users and regarding electromagnetic interference.

The declaration of compliance can be consulted on the site www.sagem-ca.at/doc.

Preservation of the environment as part of a sustainable development plan is an essential concern of Sagemcom. The desire of Sagemcom is to operate systems observing the environment. The desire of Sagemcom is to operate systems observing the environment and consequently it has decided to integrate environmental performances in the life cycle of this products, from manufacturing to commissioning use and elimination.



Packaging: The presence of the logo (green dot) means that a contribution is paid to an approved national organisation to improve package recovery and recycling infrastructures. Please respect the sorting rules set up locally for this kind of waste.

Batteries: If your product contains batteries, they must be disposed of at an appropriate collection point.



Product: The crossed-out waste bin stuck on the product means that the product belongs to the family of electrical and electronic equipment. In this respect, the European regulations ask you to dispose of it selectively;

- At sales points in the event of the purchase of similar equipment.
- At the collection points made available to you locally (drop-off centre, selective collection, etc.).

In this way you can participate in the re-use and upgrading of Electrical and Electronic Equipment Waste, which can have an effect on the environment and human health.

The paper and cardboard packaging used can be disposed of as recyclable paper. Have the plastic wrapping and Styrofoam packaging recycled or dispose of it in the non-recyclable waste, depending on the requirements in your country.

Trademarks: The mentioned references in this manual are trademarks of the respective companies. The lack of the trademarks ® and ™ does not justify the assumption that these dedicated terminologies are free trademarks. Other product names used herein are for identification purposes only and may be trademarks of their respective owners. Sagemcom disclaims any and all rights in those marks.

Neither Sagemcom nor its affiliates shall be liable to the purchaser of this product or third parties for damages, losses, costs, or expenses incurred by the purchaser or third parties as a result of accident, misuse, or abuse of this product or unauthorized modifications, repairs, or alterations to this product, or failure to strictly comply with Sagemcom operating and maintenance instructions.

Sagemcom shall not be liable for any damages or problems arising from the use of any options or any consumable materials other than those designated as original Sagemcom / PHILIPS products or Sagemcom / PHILIPS approved products.

Sagemcom shall not be held liable for any damage resulting from electromagnetic interference that occurs from the use of any interface cables other than those designated as Sagemcom / PHILIPS products.

All rights reserved. No part of this publication may be reproduced, stored in a retrieval system or transmitted in any form or by any means, electronic, mechanical, photocopying, recording, or otherwise, without the prior written permission of Sagemcom. The information contained herein is designed only for use with this product. Sagemcom is not responsible for any use of this information as applied to other devices.

This user manual is a document that does not represent a contract.

Errors, printing errors and changes are reserved.

Copyright © 2011 Sagemcom Austria GmbH



PHILIPS and the PHILIPS' Shield Emblem are registered trademarks of Koninklijke Philips Electronics N.V. and are used by Sagemcom Austria GmbH under license from Koninklijke Philips Electronics N.V.

© 2011 Sagemcom Austria GmbH

All rights reserved

Sagemcom Documents SAS

Documents Business Unit

Headquarters : 250, route de l'Empereur
92500 Rueil-Malmaison Cedex · FRANCE

Tel: +33 (0)1 57 61 10 00 · Fax: +33 (0)1 57 61 10 01

www.sagemcom.com

Simplified Joint Stock Company · Capital 8.479.978 € · 509 448 841 [RCS](#) Nanterre

PPX2450 · 2480

EN

253447695-A