



User Guide

Aastra

Aastra 7106a - analogue telephone



EN/LZT 102 4161 R1B

© Aastra Telecom Sweden AB 2011, all rights reserved.

Table of Contents

Introduction	4
Important User information	5
Telephone Parts	6
Telephone Layout	6
Cable inlets and MW switch	8
Incoming calls	9
Outgoing calls	11
During calls	13
Call forwarding	14
Optional Call handling Features	17
Speed Dial Memory	25
Phone Setting	26
System Dependent Phone Setting	27
Telephone Specification	28
Wall mounting	29

Introduction

Aastra 7106a is an easily managed line-powered analog phone. The functions and features available with this telephone are designed for easy use in all different telephone handling situations. It supports calls with excellent voice quality.

Important User information

Safety Instructions

Save these instructions



Read these safety instructions before use!

Note: *When using your telephone or connected equipment, the following basic safety precautions should always be followed to reduce risk of fire, electrical shock and other personal injury.*

- Follow instructions in the equipment's user guide or other documentation.
- Always install equipment in a location and environment for which it is designed.
- Headsets used with this equipment must comply with EN/IEC 60950-1
- Do not make any changes or modifications to equipment without seeking approval from the party responsible for compliance. Unauthorized changes or modifications could void the user's authority to operate the equipment.
- Do not use the telephone to report a gas leak in the vicinity of the leak.
- Do not spill liquid of any kind on the product or use the equipment near water, for example, near a bathtub, washbowl, and kitchen sink, in a wet basement or near a swimming pool.
- Do not insert any object into equipment slots that is not part of the product or auxiliary product.
- Do not disassemble the product. Contact a qualified service agency when service or repair work is required.
- Do not use a telephone (other than cordless type) during an electrical storm.



Disposal of the product

Your product should not be placed in municipal waste. Please check local regulations for disposal of electronic products.

Telephone Parts

When you unpack your phone, you should ensure that you have all of the following items. If any part is missing, contact the supplier of your phone.

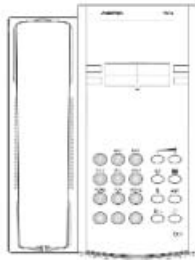

Telephone



Handset



Handset Cord



Designation Card

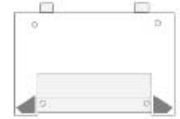

Telephone Base Desk Foot

Telephone Layout

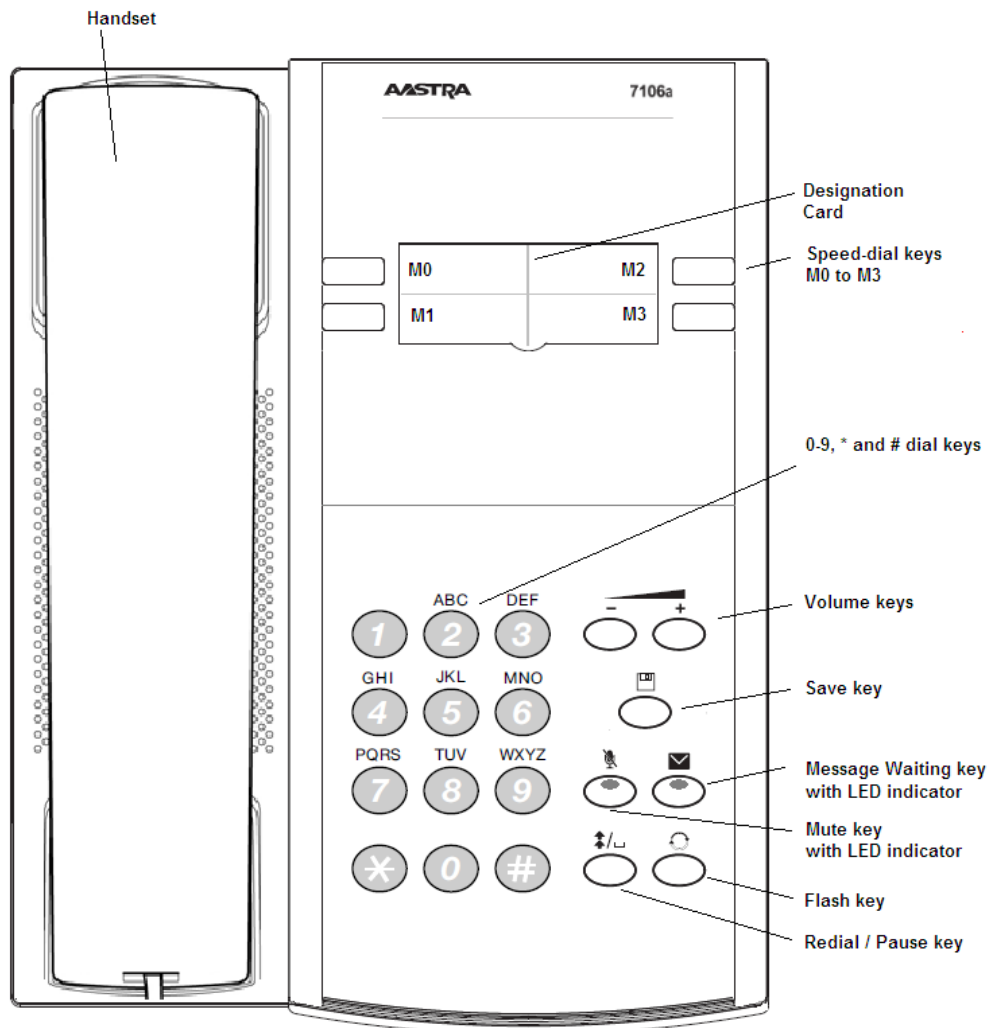





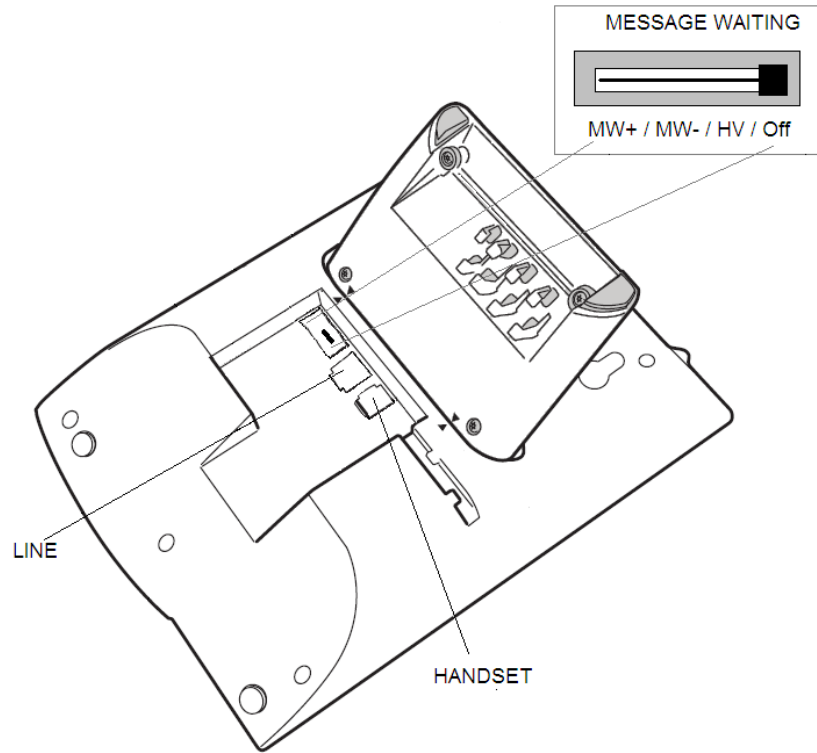

Table with Key-symbols

Symbols / Keys	French	Spanish	German	Portuguese	Dutch
Speed-dial M0-M3	<i>Numérotation abrégée Touche M0-M3</i>	<i>Teclas programables M0-M3</i>	<i>Kurzwahl M0-M3</i>	<i>Discagem rápida M0-M3</i>	<i>Snel-kiezen M0-M3</i>
Flash key 	<i>Touche R – Flash</i>	<i>Tecla Flash</i>	<i>R- Taste</i>	<i>Flash</i>	<i>Haakcontact</i>
Redial / Pause key 	<i>Touche Rappel / Mise en attente</i>	<i>Rellamada/ Pausa</i>	<i>Wahlwiederholung / Pausentaste</i>	<i>Rediscagem/tecla de pausa</i>	<i>Nummerherhaling / Pauzetoets</i>
0-9, * and # (dial keys)	<i>0-9, * and # (touches de numérotation)</i>	<i>0-9, * and # (digitos)</i>	<i>0-9, * and # (Zifferntasten)</i>	<i>0-9, * and # (Dígitos)</i>	<i>0-9, * and # (bel toetsen)</i>
Volume keys 	<i>Touches de réglage volume</i>	<i>Volumen</i>	<i>Lautstärketasten</i>	<i>Volume</i>	<i>Volume toetsen</i>
Mute key 	<i>Touche secret - Act./desactiv- Micro</i>	<i>(Mute) silencio</i>	<i>Stummtaste</i>	<i>Mudo</i>	<i>Mute-toets</i>
Save key 	<i>Touche de sauvegarde</i>	<i>Salvar</i>	<i>Speichertaste</i>	<i>Salvar</i>	<i>Opslaan</i>
Message waiting 	<i>Message en attente</i>	<i>Mensaje en espera</i>	<i>Nachricht wartet</i>	<i>Mensagem em espera</i>	<i>Wachtend bericht</i>

Cable inlets and MW switch



Symbols	French	Spanish	German	Portuguese	Dutch
Line socket	<i>Prise ligne téléphonique</i>	<i>Puerto conexión de línea</i>	<i>Anschlussbuchse</i>	<i>Conector de linha telefónica</i>	<i>Lijnpoort</i>
OFF / Hi Volt / MW(-) / MW(+)	<i>ARRET / Haute Tension / MW(-) / MW(+)</i>	<i>DE / Alto voltaje / MW(-) / MW(+)</i>	<i>AUS/Spannung/ MW(-) / MW(+)</i>	<i>OFF / Hi Volt / MW(-) / MW(+)</i>	<i>UIT / Hi Volt / MW(-) / MW(+)</i>
Handset Jack	<i>Prise pour combiné</i>	<i>Puerto de microtelefono</i>	<i>Hörerbuchse</i>	<i>Conector do monofone</i>	<i>Telefoonhoorn aansluiting</i>

Incoming calls

To answer an incoming call

Lift the handset



Answer a second call

A call waiting tone will inform you, during conversation that a second call is waiting. You have two options:

Option 1:

1. Replace the handset. The new call will be signaled on your phone
2. Lift the handset to receive the call.

Option 2:

1. Ask the party you are speaking with to wait
2. Press  and replace the handset. The waiting call will start ringing.
3. Lift the handset to receive the new call
4. Press **2** to return to the first call (Sweden, press )

After finishing the call, replace the handset to receive the first call again

Answer a call from another extension

you can answer a call to another extension from any phone in your office:

1. Lift the handset and call the ringing extension.
2. You receive a busy tone, press numeric key, **8** (France: 4. Sweden: 6)

Mute ring signal

Press  to mute the ring signal (LED flashing)

Do not disturb, DND

When you activate DND, calls to your extension is not shown.
Outgoing calls can be made as usual.

Activate DND:

Lift the handset and press numeric keys * **2 7** #, Replace the handset.

Deactivate DND:

Lift the handset and press numeric keys # **2 7** # Replace the handset.

Outgoing calls

Dial

Pick up the handset and Press numeric keys, If required the number keys can be combined with * # or ↕/↵ to dial out

Last number Redial

1. Lift the handset
2. Press ↕/↵, to call the last number you have dialed.

Last External Number Redial

1. Lift the handset and press numeric key * * *
(Finland and Sweden: * * 0)

Speed-dial by Memory Keys (M0-M3)

1. Pick up the handset.
2. Press memory key (M0 to M3).

Call Back

If a called extension is busy or there is no answer:

1. At busy tone, Press numeric key **6**, (Finland, France and Sweden: 5).
2. Replace the handset
3. Lift the handset when you are called back.

If all external lines are busy (after dialing the digit or digits to get the line:

1. At busy tone, Press numeric key, **6** (Finland, France, and Sweden: 5).
2. Dial the external number and press #,
3. Replace the handset.
4. Lift the handset when you are called back.

Cancel call back

Cancel single call back: Lift the handset and press numeric keys **# 3 7***, ext number, #, Replace the handset.

Cancel all callbacks: Lift the handset and press numeric keys **# 3 7 #**
Replace the handset.

Protection (Data Privacy)

Protection allows you to make a call without any disturbances, e.g. intrusion. The feature is automatically cancelled when the call is finished

Lift the handset and Press numeric keys *** 41 #**

Number presentation restriction

If you do not want your name and number to be displayed to the person you are calling.



1. Lift the handset and press numeric keys *** 4 2 #**
2. Dial the number

Call duration timer for out going calls



A call duration timer for outgoing calls starts 5 seconds after “off hook” status is established. The call duration is stored in the call list with the caller ID information.

During calls

Mute

1. When a call is in progress, press  to mute (LED flashing).
2. To speak to the caller, press  again (LED off).

Inquiry

1. When a call is in progress, press 
2. Call 3rd party and wait for an answer
3. Return to the first call by pressing, **2** (Sweden: )

Refer back (Switch back)

Press, **2** to refer back to the other party (Sweden: )

Transfer

1. When a call is in progress, press 
2. Call 3rd party and wait for an answer. Replace the handset before or after the answer

Conference

1. When a call is in progress, press, 
 2. Call 3rd party
 3. After answer, press numeric key **3**
- Repeat the procedure to add more conference members (max 7 members)

Hold / Park a call

1. When a call is in progress, Press  and replace the handset
2. Lift the handset to resume the call on your own extension

To resume the call from on another extension:

1. Lift the handset
2. Call the extension where the call was put on hold
3. Press numeric key **8** (France: 4. Sweden:6)

Call forwarding

Diversion

If you do not want to be disturbed or will be out of office, you can have all calls to your extension diverted to a preprogrammed answering position. Diversion can be made direct, on no answer, on busy or to another information service facility.

As a reminder that your telephone is diverted, you will hear a special dial tone each time you lift the handset to make a call.

Order direct diversion from your own extension

The call can be diverted to an individual position or up to three determined common answering positions (depending on the type of the incoming call) that are preprogrammed by your system administrator.

1. Lift the handset and Press numeric keys * **21 #** (UK: *2#)
2. Replace the handset

Cancel diversion from your own extension:

1. Lift the handset and press numeric keys **# 21 #** (UK: # 2 #),
2. Replace the handset.

To order diversion when there is no answer

1. Lift the handset and Press numeric keys * **211 #** (Finland and Norway: *61#)
2. Replace the handset

Cancel diversion when there is no answer:

1. Lift the handset and press numeric keys **# 211 #** (UK: #61#),
2. Replace the handset.

Diversion when the caller receives a busy tone

1. Lift the handset and Press numeric keys * **212 #** (Finland and Norway: *67#)
2. Replace the handset.

Cancel diversion when the caller receives a busy tone:

1. Lift the handset and press numeric keys **# 212 #** (UK: # 67 #),
2. Replace the handset.

Internal Follow me

All calls to your extension are diverted to an extension of your choice, within the private network. For example, when you are working in another room and want your calls to follow you to that answering position.

When your telephone has Follow-me you can still make calls from it as usual.

As a reminder that your telephone has Follow-me, you will hear a special dial tone each time you lift the handset to make a call.

Ordering Follow-me from your own phone

1. Lift the handset (dial tone) and press numeric keys * 2 1 * (UK:*2*)
2. Dial extension number of the answering position and press #
(Special dial tone)
3. Replace the handset.

Canceling Follow-me from your own phone

1. Lift the handset (special dial tone) and press numeric keys # 21 #
(ordinary dial tone) (UK:#2#)
2. Replace the handset

Ordering Follow-me from another phone

You can order Follow-me of your own extension number from another telephone.

The first step is to allow that Follow-me is permitted to be done from another telephone. Do the following from your own telephone:

1. Lift the handset (dial tone) and press numeric keys * 2 1 * (UK:*2*)
2. Dial own extension number and press #
3. Replace the handset

To order Follow me from another telephone:

1. Lift the handset (dial tone) and press numeric keys * 2 1 * (UK:*2*)
2. Dial own extension number * the extension number of the new answering position # (special dial tone)
3. Replace the handset

Canceling Follow-me from another phone

1. Lift the handset (dial tone) and dial #21*
2. Dial own extension number # (dial tone)
3. Replace the handset

Ordering Follow-me remotely

With this feature you can order follow-me of any extension number from any telephone. The prerequisite is that all the involved telephones have the right service profile.

To order remote programming of follow-me, do the following:

1. Lift the handset (dial tone) and press numeric keys * 2 1 * (UK:*2*)
2. Extension number to divert * extension number of the new answering position #
3. Wait for special dial tone
4. Replace the handset.

Canceling Follow-me remotely

To cancel remote programming of Follow-me from another telephone than the telephone with diverted number:

1. Lift the handset and wait for the dial tone
2. Press numeric keys # 2 1 * (UK:*2*)
3. Dial diverted extension number and press #
4. Replace the handset

External Follow me

1. Lift the handset and press numeric keys * 2 2 #
2. Dial external line code and external number press #, Replace the handset

Cancel: Lift handset and press numeric keys # 2 2 #, Replace the handset

General Cancelation

Cancel all activated features:

Lift the handset and Press numeric keys # 001 #

Optional Call handling Features

The features below may not be available in your telephony system. Please contact your system administrator.

Free seating

1. Log on: Lift the handset and press numeric keys ***11***
2. Dial Authorization code and press numeric key * Own extension number, press #

Log off: Lift handset and press numeric keys **#11#**, Replace the handset.

Personal Number

With the personal numbers and profiles feature you can be reached on your normal office phone number even if you are out of the office. A search profile (1-5) can be designed to fit the situation (in the office, traveling, at home, and so on). Both internal and external phone numbers can be used in a profile. Your search profile is programmed or modified by system administrator.

When the feature is activated, incoming calls are transferred to selected phones or back-up services in the order that you choose.

If an answering position in the profile is busy, the call can be transferred to another predefined position in the profile (Voice Mail or a colleague). You can handle the profiles from your own office phone. How to do this is described in this section (an operator can also assist you).

You can also use any of the Personal Assistant applications if available.

Contact your system administrator for more information.

When out of the office, the feature Direct Inward System Access (DISA) can be used, if available in your system.

How to use DISA is described in this section.

Activate or change profile from own extension

1. Lift handset and press numeric keys ***1 0 * (1 - 5) #**
2. Replace the handset

Canceling a profile from your phone

1. Lift handset and press numeric keys **#10 #**
2. Replace the handset

Voice Mail

Enter your mailbox:

1. Lift handset and dial the voice mail number and follow recorded instruction.

Note: if the number to the voice mail system has been programmed on the message waiting key you can also press that key to enter the mailbox

Call Waiting

If you urgently wish to contact a busy extension or external line, you can notify the extension by a call waiting signal:

1. At busy tone, press numeric keys, **5** (Finland, France: 6 Sweden: 4)
2. Wait on line

Account Code

This feature is used to charge a call to an account number or to prevent unauthorized calls from your phone. The account code can have 1-15 digits.

1. Lift handset and press numeric keys * **6 1** * *account code* #
2. Dial the digit or digits to get an external line or external line

Absence Information

The absent information is used to inform the caller why you are absent and when you will return. Contact your system administrator regarding the available absence codes.

With return date and time

1. Lift the handset and press numeric keys * **2 3** *
 2. Enter absence code (0-9) and press numeric key *
 3. Enter the date or time (*MMDD*) or time (*HHMM*), press #
- Cancel: Lift handset and press numeric keys **# 2 3 #**, Replace the handset

Without return date and time

1. Lift the handset and press numeric keys * **2 3** *
 2. Enter absence code (0-9) and press numeric key #
- Cancel: Lift handset and press numeric keys **# 2 3 #**, Replace the handset

Order for another extension:

1. Lift the handset and press numeric keys * **2 3 0** *
2. Dial the *extension number* and press *
3. Enter the absence code (0-9), press *

Enter date or time (*MMDD*) or time (*HHMM*), for the other persons return, Press #. Replace the handset.

Cancel: Lift handset and press numeric keys **#230*** *Dial extension number* and press #. Replace the handset.

Parallel Ringing

This feature makes it possible for an incoming call to ring on several phones simultaneously and for the call to be answered on any of the phones. The feature requires all the phones involved to be defined in a parallel ringing list.

To disable the parallel ringing temporarily:

1. Lift the handset and press numeric keys * **2 1** *
2. Dial *extension number* and press, #. Replace the handset

To restore Parallel Ringing:

Lift the handset and press numeric keys **# 21 #**, Replace the handset.

Intrusion on a busy extension

You can intrude on an ongoing call on a busy extension:

Lift the handset and Press numeric key **4**, (France and Sweden: 8)

Before the intrusion a warning tone is sent to the parties in the ongoing call.

Group features

Group Call – pick - up

In a call-pick-up group, any member can answer any individual call to group member.

Lift the handset and Press numeric key **8** to answer the call (Finland and Sweden: 0)

Common bell group

Calls are signaled on a common bell.

Lift the handset and Press numeric key, **8**, to answer the call (Finland and Sweden: 0)

Group hunting

As a member of a group of extensions that is called by a common number, you can temporarily leave the group.

1. Lift the handset and Press numeric keys * **2 1** * (U.K: *2*)
2. Dial your *own extension number* and press **#**. Replace the handset

To re-enter the group:

Lift the handset and press numeric keys **# 21 #**. Replace the handset (UK: #2#).

If you are authorized, you can divert all calls to a group, to another extension or another group:

1. Lift the handset and press numeric keys * **2 4** *
2. Dial number of the group to be diverted, Press numeric key *
3. Dial *extension number* to the new answering position, press **#**
Replace the handset

To cancel the diversion:

1. Lift the handset and press numeric keys **# 2 4** *
2. Dial the number of the group that has been diverted
3. Press numeric key **#**, Replace the handset.

Direct inward system Access - DISA

If you are assigned to use this feature and you are working externally, you can call your office and get access to an external line in order to make business calls.

With common authorization code:

1. Lift the handset and call the DISA feature in your office.
2. You receive dial tone, press numeric keys *** 7 2 ***
3. Dial the *authorization code* and press numeric key **#**
4. You receive a dial tone, Dial external number

With individual Authorization code:

1. Lift the handset and call the DISA feature in your office.
2. You receive dial tone, press numeric keys: *** 7 5 ***
3. Dial the *authorization code* and press numeric key *****
4. You receive a dial tone, Dial *external number*, press *****
5. Dial your *own extension number* and press **#**
6. You receive a dial tone. Dial external number

Authorization code, Common

If you are authorized to use a common authorization code (1 to 7 digits) you can temporarily change any phone used within the telephone system to the authority level connected to this code.

For a single call:

1. Lift the handset and press numeric keys * **7 2** *
2. Enter *authorization code* and press #
3. You receive a verification tone, Dial the digit or digits to get an external line and the external number.

To open an extension for several calls:

1. Lift the handset and press numeric keys # **7 3** *
2. Enter *authorization code* and press #
3. You receive a verification tone.

To lock an extension:

1. Lift the handset and press numeric keys * **73***
2. Enter *authorization code* and press #
3. You receive a verification tone.

Authorization code, individual

If you are authorized to use an individual authorization code (1-7 digits, affiliated to your own extension) you can lock your own extension to a common authority level, e.g. when out of the office. You can also temporarily change any other phone used within the telephone system to the same authority level as you have on your own phone. The individual code can be changed from your own extension.

To lock the phone:

1. Lift the handset and press numeric keys * **76** *
2. Enter *authorization code* and press #
3. You receive a verification tone.

To make calls with your authority level when your phone is locked:

1. Lift the handset and press numeric keys ***75** *
2. Enter *authorization code* and press #
3. Dial the digit or digits to get an external line and the external number.

To open your phone:

1. Lift the handset and press numeric keys # **76** *
2. Enter *authorization code* and press #
3. You receive a verification tone.

To assign your own authority level to another phone:

1. Lift the handset and press numeric key * **75** *
2. Enter *authorization code* and press *
3. You receive verification tone
4. Enter your *own extension number* and press #
5. You receive verification tone, Dial the digit or digits to get an external line and the external number.



To change your individual authorization code:

1. Lift the handset and press numeric keys * **74** *
2. Enter *old authorization code* and press *
3. Enter new authorization code and press #
4. You receive verification tone.

Speed Dial Memory

There are 4 memory keys (M0-M3) for storing frequently used numbers. The number card is intended for noting the name.

Save telephone number

1. Place the handset on the phone
2. Press one memory key (M0 to M3)
3. Press  and enter the number to be saved
4. Press  key again to complete saving

*Note: For some rare conditions it may be useful to insert a **pause** between e.g. the area code and the phone number. To do this; enter the area code, press the pause key and then continue with the telephone number.*

Dial from a Memory

1. Pick up the handset
2. Press the memory key (M0 to M3) to be dialed

Delete/ Change a saved number

There is no special delete or change procedure. Instead the “save procedure” is used.

1. To delete a number
Follow the Save procedure starting with step 1 but do not enter a new number in the 3rd step. In this way you “save no number” which will clear the memory in step 4.
2. To change a stored number
Follow the Save procedure and enter a new number in step 3 and finish the save procedure in step 4. In this way the previous number will be replaced.

Phone Setting

Set Ring Volume

Three levels of ring volume is provided: **High, Low, Silence**

1. Place the handset on the phone
2. Press 'Volume +' to increase ring volume
3. Press 'Volume –' to decrease ring volume.

To disable the ring signal for incoming calls press the 'Volume –' until reaching **Silence** level or press  during on-hook. The Mute LED will remain ON during on-hook to indicate the ring is now in silence.

Set Handset Volume

Four levels of handsfree volume is provided: **Level 1 to 4**

1. Pick up the handset
2. Press 'Volume +' to increase the handset volume
3. Press 'Volume –' to decrease the handset volume

Set Ring Melody



1. During On-hook, press  and keys **# 0 2 # (X) #**.
X could be set from 1 to 8 (melodies 1–8).

System Dependent Phone Setting

Message Waiting Memory (MWM)

There is a message waiting memory in the telephone where the number to the voicemail box shall be stored.

Save MWM

1. Place the handset on the phone and press 
2. Press  and enter the number to be saved
3. Press  key again to complete saving

Dial from a MWM

1. Pick up the handset or press 'Speaker/Handset'
2. Press the 

Message Waiting LED

When there is a message, the message waiting LED will be lighted ON or flashing in blue.

The Message Waiting switch (at the back of the phone) is used to select the appropriate MW mode (HV / + / -). Please check which MW type the PBX system supports. Select "OFF" on the MW switch to deactivate the message waiting function.

If the LED is steady active, change the message waiting switch position.

Set Flash time

Some systems require a different flash time for the flash key. To change the flash time, proceed as follows:

1. Press  # 0 1 # X #
where X is the flash time value between 1 and 9. See table below

Parameters	Programming key sequence	Lock Protected	Valid Settings	Default
Set flash time	[save]+[#]+[0]+ [1]+[#]+[X]+[#]	Yes	1: 100ms 2: 200ms 3: 300ms 4: 400ms 6: 600ms 9: 900ms	100ms

Telephone Specification

Main Characteristics	
Professional Telephone	Single line
Signaling	Analog (DTMF)
Market Certification	Europe (CE)
Body Color	Dark Grey

Features	
DTMF dialing	Yes
Number memory	Stores 4 telephone numbers
Last number Redial	Yes
Flash function (R)	100 ms (default)
Programmable flash time	100 ms, 200 ms, 300 ms, 400 ms, 600 ms, 900 ms
Hearing aid compatible	Yes
Volume control	Handset (4 levels)
Microphone mute	Yes
Message waiting (MW)	4 alternatives supported: MW+/MW-/HV/Off
Ringer melody	8 types
Ringer volume	2 levels
Ringer silence	Yes

Hardware	
Speed dialing keys	4
Memory Card	1
Redial/Pause	1
Flash key (R)	1
Mute key with LED	1
MW with LED indicator	1
Save	1
Volume control	2
Handset receiver	Electro-dynamic
Microphone	Electret
Tone ringer	Piezo type
Wall Hanging	Yes

Accessories	
Connection cable, RJ11/ RJ45	1 pcs, 2 meters (not included)
Number card	1 pcs (not included)

Wall mounting

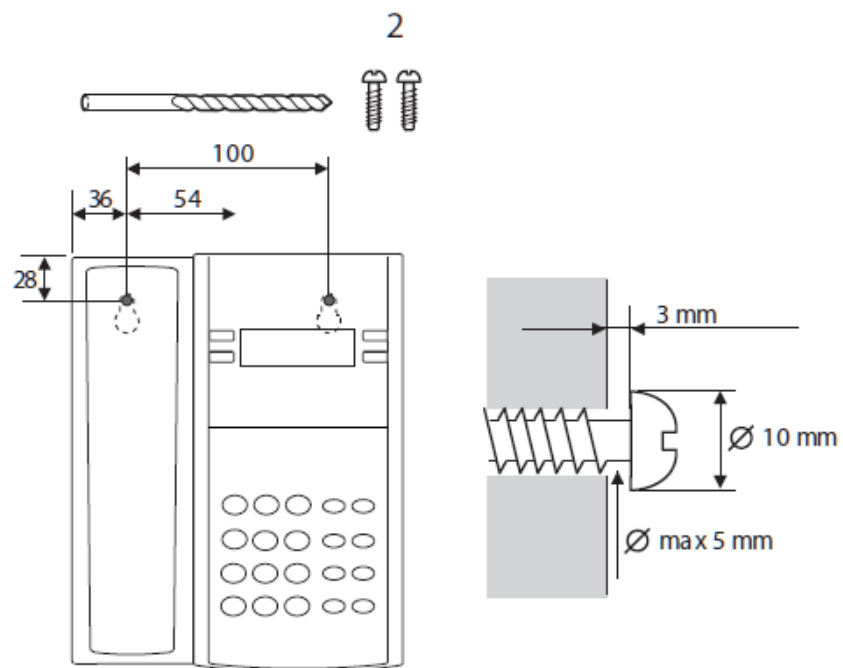
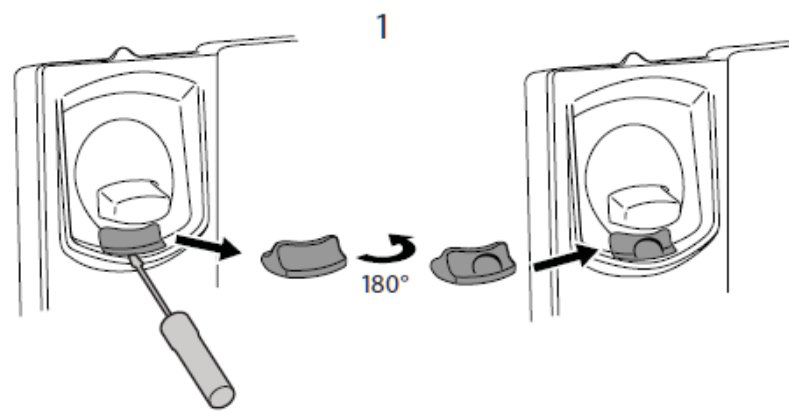

Copyright ©

Copyright Aastra Telecom Sweden AB, 2011. All rights reserved.

Trademark

Aastra is a registered trademark of Aastra Technologies Limited. All other trademarks mentioned herein are the property of their respective

Disclaimer

Aastra Technologies Limited will not accept liability for any damages and/or long distance charges, which result from unauthorized and/or unlawful use. While every effort has been made to ensure accuracy, Aastra Technologies Limited will not be liable for technical or editorial errors or omissions contained within this documentation. The information contained in this documentation is subject to change without notice.

Declaration of conformity

Hereby, Aastra Telecom Sweden AB, Box 42214, SE-126 17 Stockholm, declares that this telephone is in conformity with the essential requirements and other relevant provisions of the European Directive 1999/5/EC (R&TTE Directive).

Details to be found at: <http://www.aastra.com>.

