

StarBoard FX-TRIO Series

User's Guide

How to Request a User's Guide

When requesting a separate copy of this User's Guide, specify FXT-EU100101.

| |
|--|
| Read this User's Guide and carefully retain it for future reference. |
|--|

| |
|---|
| Before using this product, carefully read and fully understand the safety instructions. |
|---|

| |
|---|
| Store this User's Guide nearby for ease of reference. |
|---|

FXT-EU100101

HitachiSoft

Notices

Reproduction or reprinting, without permission, of this User's Guide or any part thereof is prohibited.

The contents of this User's Guide are subject to change without prior notice.

Every effort has been made to ensure that this User's Guide is complete and correct. However, should any questionable points, mistakes, etc., come to your attention, please inform the vendor. Hitachi Software Engineering Co., Ltd., assumes no responsibility for losses resulting from or related to the use of this product. Refer to "3. Appendix 3.7 Product Warranty Policy" at the end of this User's Guide for details on the warranty and liabilities.

Disclaimers

Hitachi Software Engineering Co., Ltd. assumes no liability and makes no warranty, either express or implicit, regarding the contents of this User's Guide.

Also, the company makes no warranty as to the product's suitability, merchantability or fitness for a particular intended use.

All products of Hitachi Software Engineering Co., Ltd., described in this User's Guide are presently for sale or are site-licensed.

Users who purchased the aforesaid product(s) will bear the costs of all required services, repairs, and damages resulting from defects in this product, and will bear the costs of direct or indirect damages (including the loss of profits or required information) that resulted from the product defects.

Moreover, Hitachi Software Engineering Co., Ltd., retains the right to revise this User's Guide and to modify the contents thereof, without any obligation to notify anyone.

Product Assurance Provisions

This product is limited to use in the country where the user bought this product.

For warranty details, refer to “3. Appendix 3.7 Product Warranty Policy” at the end of this User’s Guide.

This second version of the User’s Guide (FXT-EU100101) is for the following products:

AH00243: StarBoard FX-TRIO-77

AH00180: Electronic Pen

K-W033-021: Stand

Windows is a trademark of Microsoft Corporation (U.S.) and in other countries.

Other trademarks and product names are trademarks and/or registered trademarks of their respective holders

Manual Creation Dates

January 2010 Second version FXT-EU100101

All Right Reserved, Copyright(c) 2009, 2010, Hitachi Software Engineering Co.,Ltd.

Introduction

Thank you very much for purchasing Hitachisoft' s StarBoard FX-TRIO (henceforth referred to as "StarBoard").

This User's Guide has been created for people who already have a working knowledge of personal computers (henceforth referred to as "PC").



Please make sure that you understand the contents of this User's Guide and use the software correctly.



We hope that you make the most of this product.

Safe Handling

Markings and Symbols

Various markings and symbols are used in this User's Guide and on this product, to ensure the safe and correct use of this product and to prevent personal injury and property damage. These symbols and their meanings are as explained below. Understand the information well before reading the body of the User's Guide.





| | |
|---|--|
|  | This is a Safety Warning symbol. This symbol will appear to raise the attention of the user to existing risks that may cause harm to people. To avoid any chances of injuries or possibly death, DO NOT IGNORE the safety instructions that follow this symbol. |
|  | WARNINGS This warning will appear where there exists a risk of death or fatal injuries. |
|  | CAUTIONS This warning will appear where there exists a risk of moderate or light injuries. |
| | NOTICE This warning will appear where there exists a risk of damage to property. |





| | |
|---|---|
|  | This symbol draws attention to cautions (including warnings). |
|  | This symbol indicates something prohibited. |
|  | This symbol indicates something that must be done. |

Safe Precautions



Required Precautions

(1) Precautions Regarding Operation







|  WARNINGS | |
|---|--|
|  | <p>Do not make modifications.</p> <p>Do not make any adjustments, repairs, or modifications not given in this User's Guide as doing so may lead to personal injury or damage to the product.</p> |
|  | <p>Do not open or remove cover of this product.</p> <p>Failure to comply may lead to personal injury or damage to the product. Refer internal inspections, adjustments, and repairs to your dealer or support center.</p> |
|  | <p>Do not place objects on top of this product.</p> <p>If a foreign object falls on top of or inside this product, it may lead to personal injury or damage to the product.</p> |



| NOTICE | |
|---|--|
|  | <p>Do not allow the reflective tape surrounding the board to become dirty or scratched.</p> <p>If the reflective tape becomes dirty or scratched, it may lead to improper coordinate detection.</p> |
|  | <p>Do not use a USB cable extended.</p> <p>Use of a USB cable extended may result in malfunction.</p> |
|  | <p>Do not place heavy objects on, pull on, or subject the USB cable to excess heat.</p> <p>Failure to comply may result damage to the USB cable.</p> |
|  | <p>Always grasp the plug of the USB cable when connecting or disconnecting.</p> <p>Pulling on the USB cable may result in scratching or damage to the cable.</p> |
|  | <p>Always lock the casters with stoppers on the front side after installing this product.</p> <p>Failure to lock the casters may allow the product to move or slide.</p> |

(2) Dealing with Trouble





|  CAUTIONS | |
|---|---|
|  | <p>What to do in case of emission of smoke, strange odor, or strange noise</p> <p>If an abnormal condition such as emission of smoke, strange odor, or strange noise happens to occur for some reason, immediately disconnect the product's USB cable from the PC.</p> <p>Confirm that the smoke or strange odor is no longer being emitted and contact a support center to request repairs.</p> <p>Continued operation without repair may result in fire.</p> |
|  | <p>What to do if the product breaks or the USB cable is damaged</p> <p>If this product breaks or the USB cable becomes damaged for some reason, immediately disconnect the USB cable from the PC and contact a support center.</p> <p>Continued operation without repair may result in emission of a strange odor or smoke.</p> |

(3) Precautions Regarding Handling





|  WARNINGS | |
|---|---|
|  | <p>Do not hang from or climb on this product.</p> <p>Failure to comply may result in personal injury if the product falls, collapses, or breaks into pieces. Be particularly careful in the case of small children.</p> |
|  | <p>Do not touch this product if you hear thunder.</p> <p>Failure to comply may result in electric shock.</p> |
|  CAUTIONS | |
|  | <p>Do not use batteries other than those specified.</p> <p>Failure to comply may result in fire, personal injury, and/or soiling of the surrounding area due to batteries bursting or leaking fluid.</p> |
|  | <p>Do not splash with water or chemical compounds.</p> <p>Do not place this product in a location subject to contact with water droplets or place any containers containing water or other chemical compounds on top of or nearby this product.</p> <p>Failure to comply may result in damage or fire if water or chemical compounds get inside this product.</p> |





| NOTICE | |
|---|--|
|  | <p>Disconnect the USB cable during extended periods of non-use. For safety reasons, disconnect the USB cable if the product is not going to be used for an extended period of time. Failure to comply may result in malfunction.</p> |
|  | <p>Handle the connection cable properly. Improper handling of the connection cable such as jamming it against a wall, undue bending, pulling, or twisting may result in overheating or damage due to exposure of the conductive core, electrical short, or severing of the cable.</p> |





(4) Precautions Regarding Moving the Product

|  CAUTIONS | |
|---|--|
|  | <p>Always use two or more people to move this product. This product is a very large and heavy precision instrument. Always use two or more people and take great care when moving this product. Result in the personal injury or breakdown if the product falls over.</p> |
|  | <p>Always disconnect the USB cable from the PC when moving this product. Failure to comply may result in damage to the USB cable and/or the product itself.</p> |
|  | <p>Do not subject to shock of impact. This product is a precision instrument. Excessive shock of impact may hinder further operation. Take extreme care when moving this product.</p> |

(5) Precautions Regarding Setup Environment

|  WARNINGS | |
|---|---|
|  | <p>Wall mounting work should be performed by a construction specialist. Improper work may result in death or personal injury due to the product falling during operation. Always use the specified mounting unit.</p> |
|  | <p>Improper assembly may cause the product to fall over. There is risk of personal injury if the product falls over. Completely tighten the screws of all individual parts.</p> |
|  | <p>Do not place in a location with flammable or corrosive gas. Placing this product in a location where there is flammable or corrosive gas may result in fire or damage to this product. There is a particular danger of explosion in the case of flammable gas. Do not place in a location with flammable or corrosive gas.</p> |

|  CAUTIONS | |
|---|--|
|  | <p>Do not touch internally mounted parts. Directly touching internally mounted parts inside this product may result in personal injury or damage to this product.</p> |
|  | <p>Do not place in locations subject to excess moisture, dust, smoke, or steam. Placement in a location such as next to a kitchen or a humidifier may result in fire or damage to this product.</p> |
|  | <p>Do not use this product near water. If water somehow gets inside this product, immediately disconnect the USB cable and contact a support center. Continued use may result in fire or damage to this product.</p> |

| NOTICE | |
|--|---|
|  | <p>Regarding the setup environment Set up this product on a level floor surface with a weight bearing capacity of 150 kg/m² or more, and which is made of floor materials that will not deform or become depressed due to movement by casters.</p> |
|  | <p>Do not use this product in locations subject to high temperature or high humidity. This product's usage environment conditions: Temperature: 5°C – 35°C Humidity: 20%RH – 80%RH (no condensation)</p> |
|  | <p>Do not set up in locations subject to vibration and/or shock of impact. Vibration and/or shock of impact may harm internal components of this product, resulting in damage to it. Do not set up this product in a location subject to vibration or shock of impact.</p> |
|  | <p>Do not set up this product near a high-voltage line or power source. If this product is set up near high-voltage lines or power sources, it might receive interference.</p> |
|  | <p>Do not set up in a location subject to direct sunlight or near a heater. Failure to comply may result in deformation of or damage to this product.</p> |

(6) Precautions Regarding Disposal

| NOTICE | |
|---|---|
|  | <p>At time of disposal, handle this product as industrial waste according to all applicable laws and regulations. When disposing of this product, the user should follow all laws and regulations of the locality in which it is being used.</p> |

Careful thought was given to the cautions on this device and in this User’s Guide. However, unanticipated circumstances might occur. When operating this product, users themselves must exercise caution as well as follow instructions.

 **WARNINGS**

| Warnings Contents | Page(s) |
|---|---------|
| <p>Keep the wall material in mind when installing.</p> <p>Installation by means not suited to the wall material in question may result in the board falling. Furthermore, wall installation may not be possible depending on the wall. For details, consult with your dealer.</p> | P.1-8 |
| <p>Keep the wall strength in mind when installing.</p> <p>Only use this product after confirming that it is securely attached and will not fall. Furthermore, be sure to install using a wall-mounting bracket capable of supporting a weight of at least 50 kg when using FX-TRIO-77.</p> | P.1-8 |
| <p>Tighten the screws securely.</p> <p>Failure to comply may cause the stand to collapse, resulting in personal injury, or may cause damage to this product due to shock of impact from the board falling.</p> | P.1-10 |
| <p>Tighten the screws securely.</p> <p>Failure to comply may cause the board to fall, resulting in personal injury, or may cause damage to this product due to shock of impact from the board falling.</p> | P.1-11 |

 **CAUTIONS**

| Cautions Contents | Page(s) |
|---|---------------------------|
| <p>Be sure to use two or more people for this work.</p> <p>Failure to comply may cause the board to fall, resulting in personal injury, or may cause damage to this product due to shock of impact.</p> | P.1-9 P.1-11 P.1-12 |
| <p>Do not strike the board forcefully with the stylus pen, bend it, or apply an excessive load to it.</p> <p>Failure to comply may result in damage to the stylus pen or personal injury.</p> | P.2-3 |
| <p>Be sure to install batteries correctly.</p> <p>Do not install batteries with positive and negative terminals reversed, or use batteries other than the type specified. It will cause pen malfunctions and excess heat, or burns to the hand.</p> | P.2-4 |
| <p>Be sure to provide insulation during disposal.</p> <p>Be sure to insulate the positive and negative terminals of the battery using cellophane tape, or similar material when disposing of batteries. Disposing of batteries without insulating them may lead to overheating, bursting, or ignition due to shorting, resulting in personal injury or fire. Furthermore, be sure to follow all local rules and regulations regarding proper battery disposal.</p> | P.2-4 |

Contents

| | |
|--|------------|
| 1. INTRODUCTION | 1-1 |
| 1.1 PREPARATIONS | 1-1 |
| 1.1.1 <i>Product Outline</i> | 1-1 |
| 1.1.2 <i>Features</i> | 1-1 |
| 1.2 PARTS CHECK | 1-2 |
| 1.2.1 <i>StarBoard</i> | 1-2 |
| 1.2.2 <i>Stand (option)</i> | 1-3 |
| 1.2.3 <i>Electronic Pen (option)</i> | 1-4 |
| 1.3 ROLE OF EACH PART | 1-5 |
| 1.3.1 <i>StarBoard</i> | 1-5 |
| 1.3.2 <i>Function Area</i> | 1-6 |
| 1.3.3 <i>Electronic Pen (option)</i> | 1-7 |
| 1.4 ASSEMBLY AND SETUP | 1-7 |
| 1.4.1 <i>Wall-Mounting Setup Method</i> | 1-8 |
| 1.4.2 <i>Stand Setup Method</i> | 1-10 |
| 1.4.3 <i>Pen Holder Setup Method</i> | 1-13 |
| 1.4.4 <i>Equipment Connection Method</i> | 1-15 |
| 2. HOW TO USE | 2-1 |
| 2.1 HOW TO USE TOUCH MODE | 2-1 |
| 2.1.1 <i>Character Input</i> | 2-1 |
| 2.1.2 <i>PC Operations</i> | 2-2 |
| 2.2 HOW TO USER THE ELECTRONIC PEN..... | 2-4 |
| 2.2.1 <i>Inserting the Battery</i> | 2-4 |
| 2.2.2 <i>Using the Electronic Pen</i> | 2-5 |
| 2.2.3 <i>Basic Operations of the Electronic Pen</i> | 2-6 |
| 2.2.4 <i>Customizing the Electronic Pen</i> | 2-6 |
| 2.3 START METHOD | 2-7 |
| 2.3.1 <i>Start Method</i> | 2-7 |
| 3. APPENDIX | 3-1 |
| 3.1 TROUBLESHOOTING | 3-1 |
| 3.2 ADJUSTING THE SENSOR | 3-4 |
| 3.2.1 <i>Items to Check Before Making Sensor Adjustments</i> | 3-4 |
| 3.2.2 <i>Sensor Adjustment Procedure</i> | 3-4 |
| 3.3 REGULARLY AUTO SENSOR ADJUSTMENT | 3-6 |
| 3.3.1 <i>Sensor Auto Adjustment Procedure</i> | 3-6 |
| 3.4 SYSTEM SPECIFICATIONS..... | 3-8 |
| 3.5 PROPER CARE AND CLEANING..... | 3-9 |

| | |
|----------------------------------|------|
| 3.6 REPLACEABLE PARTS..... | 3-9 |
| 3.7 PRODUCT WARRANTY POLICY..... | 3-10 |

1. Introduction

1.1 Preparations

This chapter describes the preparations to be made before using StarBoard.

First-time users of StarBoard should read through this chapter.

1.1.1 Product Outline

The StarBoard FX-TRIO is an extremely convenient and easy-to-use electronic whiteboard. After setting up the provided software on a PC that is connected to a projector, you can use your finger or the stylus pen that is included with the product to operate the PC or import to the PC in real time characters or images that are drawn on the whiteboard.

1.1.2 Features

- You can use your finger or the pen to operate the PC

You can use your finger or the pen to operate a PC screen that is projected onto the board with a projector. Two pen types are available: the stylus pen that is included with the product, and an electronic pen that is option. When the term “pen” is used in this User’s Guide, it means “electronic pen.”

- You can write three people at the same time

Three people can input simultaneously with dedicated purpose tools or contents. It is effective for class and presentation.

- You can write directly onto the PC screen

After installing the provided StarBoard Software onto a PC, you can use your finger or the pen to write characters or images directly onto the PC screen. The input characters or drawn images are imported as digital data in real time into the PC, where they can be saved or printed.

- Available immediately after starting the PC

After the provided StarBoard Software is installed onto the PC, StarBoard can be used as soon as the PC is started.

- Compatible with PowerPoint presentations

Characters or images can be written into presentations created with Microsoft PowerPoint, which significantly improves the expressive power of the presentations. StarBoard can also be used in teleconferencing.

- You can also write on video images

Characters or images can be written onto captured video image displays. This makes it easy to use video materials in lessons or presentations.

1.2 Parts Check

After unpacking, make sure that all the following parts are present.

1.2.1 StarBoard

[1] Parts

| No. | Name | Qty |
|-----|---------------------------------------|-----|
| (1) | StarBoard | 1 |
| (2) | Pen holder (with installation part) | 1 |
| (3) | Stylus pen | 2 |
| (4) | Wall-mounting bracket | 2 |
| (5) | StarBoard Software x.x (※1) | 1 |
| (6) | StarBoard Software Installation Guide | 1 |
| (7) | Startup guide | 1 |
| (8) | Warranty Sheet | 1 |
| (9) | Sponge mat | 2 |

(※1) The term “x.x” as used in this User’s Guide denotes the same version as the software that is provided with the accessories.

(1)

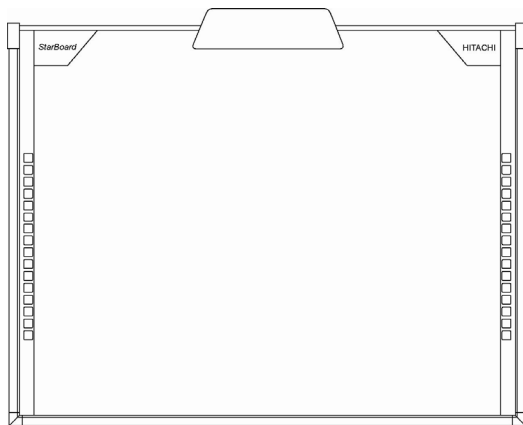

(2)

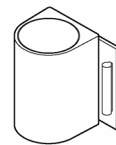

(3)

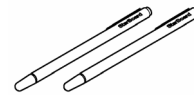

(4)

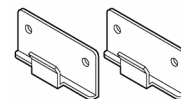

(5)

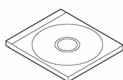

(6)



(7)

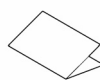

(8)



(9)

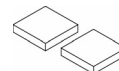

1.2.2 Stand (option)

[1] Parts

| No. | Name | Qty |
|------|--|-----|
| (1) | Stand vertical support | 2 |
| (2) | Stand crossbar | 2 |
| (3) | Stand foot with casters | 2 |
| (4) | Board receiving bracket (left-hand version) | 1 |
| (5) | Board receiving bracket (right-hand version) | 1 |
| (6) | Board fixing bracket | 2 |
| (7) | Hex socket head cap screw, with collar | 8 |
| (8) | Hex socket head cap screw | 4 |
| (9) | Pan head screw | 8 |
| (10) | Triangular knob screw | 2 |

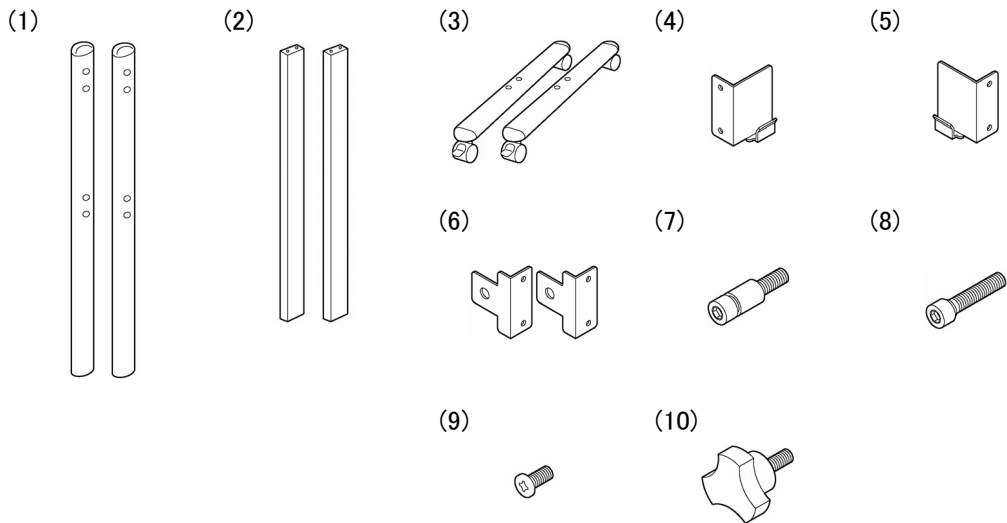

[2] Accessories

| No. | Name | Qty |
|-----|-----------------------|-----|
| (1) | Hexagon wrench | 1 |
| (2) | Hexagon wrench holder | 1 |

(2) is used to prevent the loss of the Hexagon wrench. Hang it from an appropriate place on the stand.

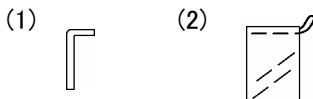

1.2.3 Electronic Pen (option)

[1] Parts

| No. | Name | Qty |
|-----|----------------------|-----|
| (1) | Electronic pen | 1 |
| (2) | AAA alkaline battery | 1 |
| (3) | Spare pen tip | 2 |

(1)

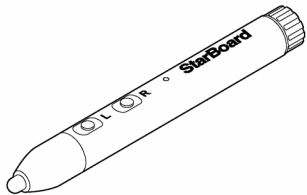

(2)

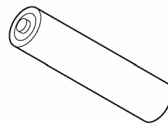

(3)

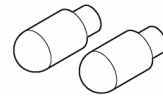

1.3 Role of Each Part

1.3.1 StarBoard

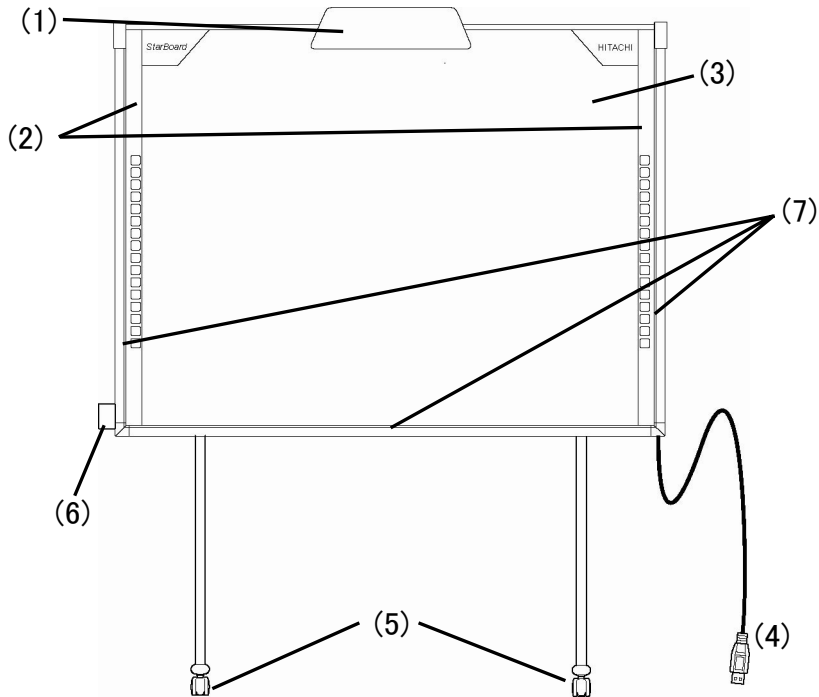

(1) Digitiser Storage Area

Receives information regarding characters or images drawn with the pen or the user's finger, and transmits this data to the PC.

(2) Function Area (Left and Right)

Shortcut buttons for functions that are frequently used in applications are located here. (Refer to the next page for details.)

(3) Input Area

Characters or images drawn in this area are imported into the PC. When using the StarBoard in Projection Mode, make sure that the image projected from the projector is kept within this area.

(4) USB Cable

Used to connect the StarBoard with the PC.

(5) Casters

These are the casters for moving the board. After setting up the StarBoard, be sure to lock the casters. Lift up the tab to unlock a caster and press down the tab to lock it.

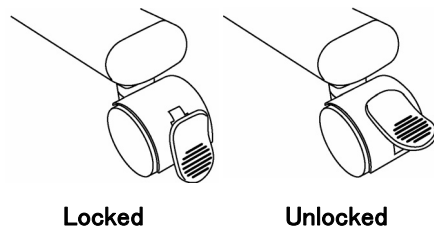

(6) Pen Holder















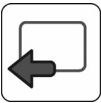

Keep the pen in the pen holder when you are not using it.

(7) Reflective tape (Inner Side of the Frame)

Reflects light. Used to capture pen or finger operations.

1.3.2 Function Area

The function area is provided with shortcut keys for the functions that are frequently used in the StarBoard Software. Use by clicking the middle of the symbol with your pen or finger. With the exception of touch mode/pen mode selection and one-time right click, you can customise the shortcuts with the software.

| Symbol | Description | Symbol | Description |
|---|--|---|--|
|  | Select touch mode or pen mode. |  | Select Solid Pen (black). |
|  | Select one-time right click. (*1) |  | Select Solid Pen (red). |
|  | Hides/displays the StarBoard Software Toolbar. |  | Select Solid Pen (blue). |
|  | Adds a new blank page. |  | Select Solid Pen (green). |
|  | Show previous page. |  | Select Fluorescent Marker Pen. |
|  | Show next page. |  | Select Eraser. |
|  | Hides/displays the Topic List. |  | Customisable button 1 (Calibration is set as the default) |
|  | Switch to PC Operation. |  | Customisable button 2 (Blank is set as the default) |

(*1) About one-time right click:

- When the one-time right click function button is pressed, the next finger or electronic pen input becomes right-click operational one time only.
- After the function button is pressed, the one-time right click operation is not canceled until a finger or electronic pen input is made.

1.3.3 Electronic Pen (option)

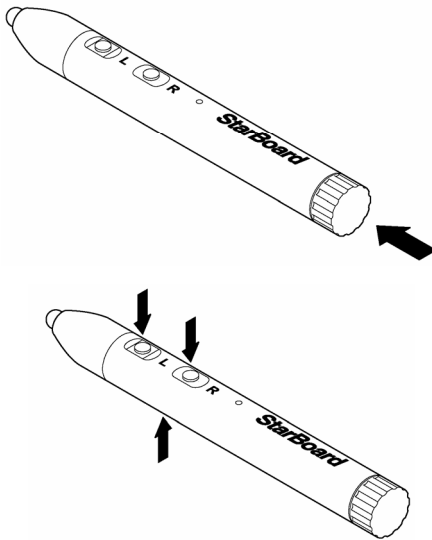

(1) Battery cover

Open the cover when inserting or replacing the battery. Refer to page 2-4 in this User's Guide for details.

(2) Side buttons

Mouse Operations assigned to these buttons. Refer to page 2-6 in this User's Guide for details.

1.4 Assembly and Setup

When setting up the board, keep the following in mind.

NOTICE

- Select a level and stable position.
- Do not set it up near equipment that might generate electromagnetic waves or radio frequencies, such as radio transmitters, televisions, copying machines or air conditioners.
- Avoid locations that are dusty, that are subject to extremely high or low temperatures or humidity, or that are exposed to direct sunlight.

1.4.1 Wall-Mounting Setup Method

! WARNINGS**Keep the wall material in mind when installing.**

Installing the board on to the wall in a way that does not suite the wall material, may result in the board falling off the wall causing injuries or damage to the board. Furthermore, wall installation may not be possible depending on the wall. For details, consult with your dealer.

Keep the wall strength in mind when installing.

Only use this product after confirming that it is securely attached and will not fall. Furthermore, be sure to install using a wall-mounting bracket capable of supporting a weight of at least 50 kg when using FX-TRIO-77.

[1] Install the wall-mounting brackets

Determine the height at which the board will be installed, and install the wall-mounting brackets on the wall at the positions shown in the following diagram below.

The wall-mounting brackets are provided with the StarBoard. ((4) on page 1-2)

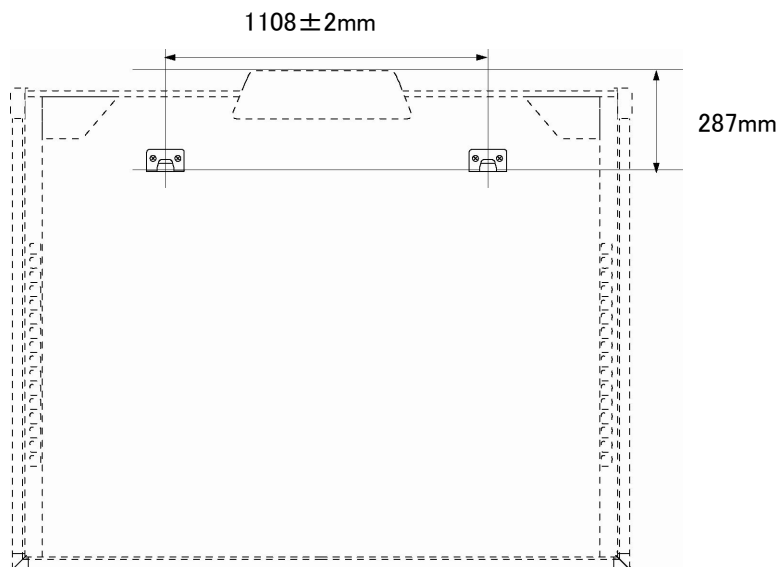

[2] Install the board

⚠ CAUTION

Be sure to use two or more people for this work.

Failure to comply may cause the board to fall, resulting in personal injury, or may cause damage to this product due to shock of impact.

Attach the small sponge lower of height adjustment stay as shown in figure.

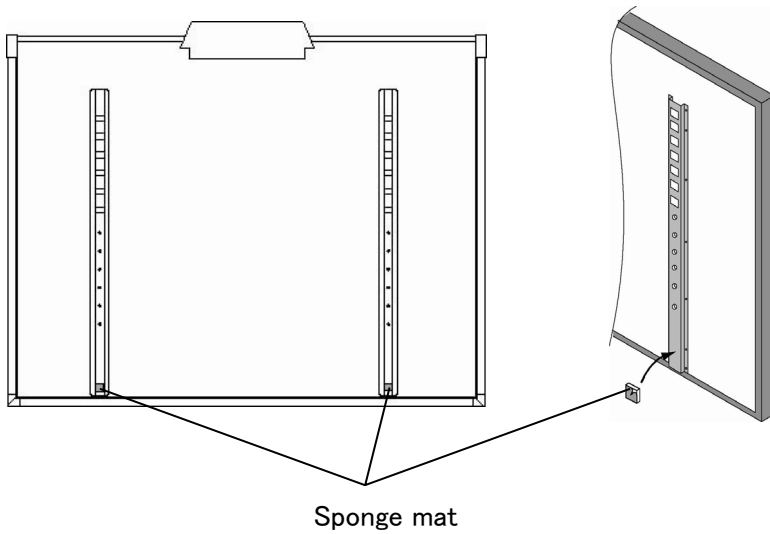

Attach the wall-mounting brackets to the top hooking holes (both sides) of the stays on the back of the board. Fix the board by attaching the sponge mat on the wall.

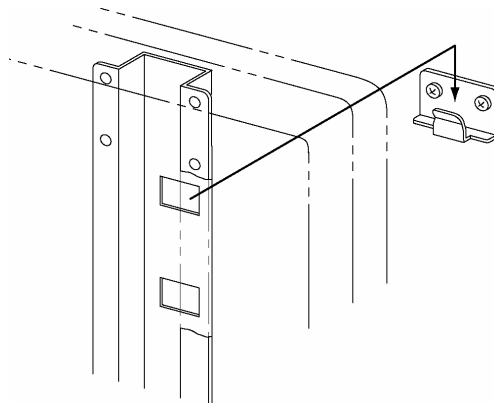

1.4.2 Stand Setup Method

Reconfirm that all the parts are present before assembling and setting up the stand (option).

| |
|--|
|  WARNINGS |
| Tighten the screws securely. Failure to comply may cause the stand to collapse, resulting in personal injury, or may cause damage to this product due to shock of impact from the board falling. |

[1] Assemble the stand
FX-TRIO-77 is available with the stand.

Assemble the stand according to the following diagram. The numbers in the diagram correspond to the numbers in the parts list on page 1-3.

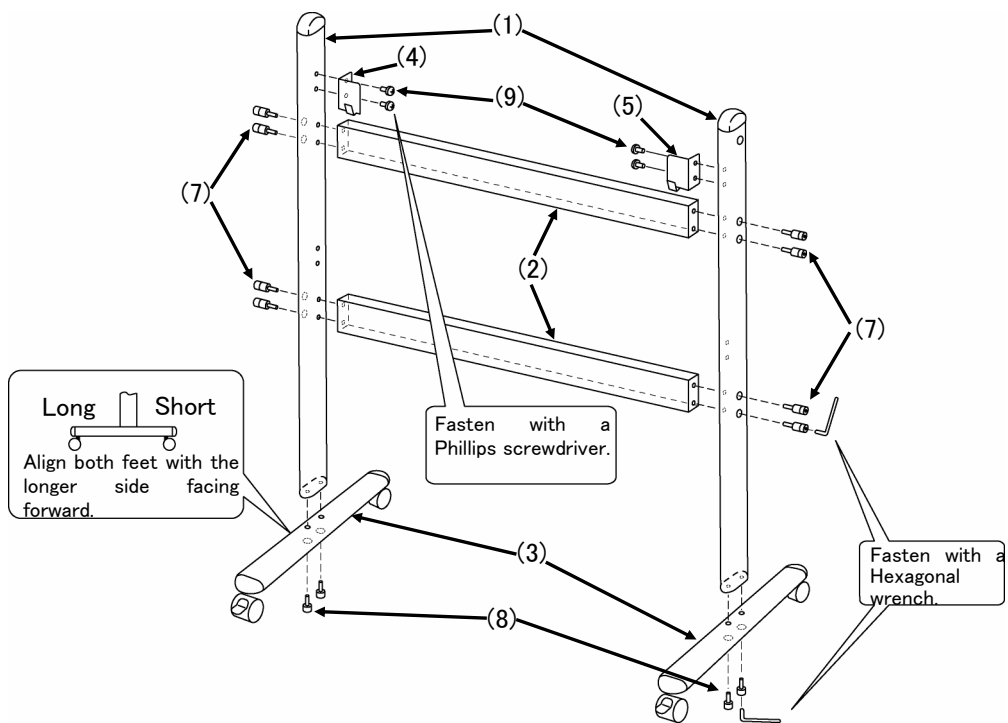

[2] Install the board

CAUTION

Be sure to use two or more people for this work.

Failure to comply may cause the board to fall, resulting in personal injury, or may cause damage to this product due to shock of impact.

Tighten the screws securely.

Failure to comply may cause the board to fall, resulting in personal injury, or may cause damage to this product due to shock of impact from the board falling.

Install the board on the stand assembled in step [1]. Install the board according to the following procedure. Note that this work should be performed by two or more people. The numbers in the diagram correspond to the numbers in the parts list on page 1–3 of this User's Guide.

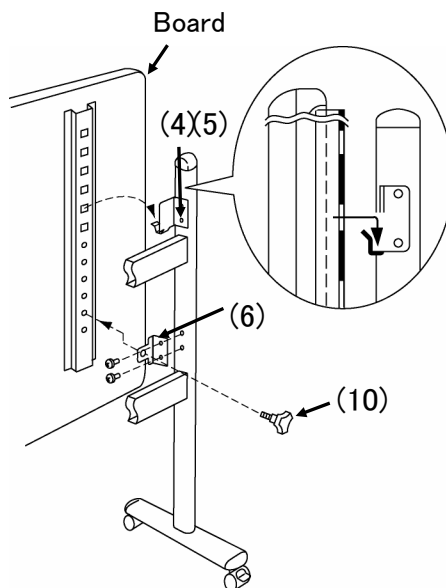

- (a) Decide the level (out of six) at which the board will be installed, and attach the board receiving brackets (4) and (5) to the square holes of the stays on the back of the board.
- (b) Verify that the square holes are attached securely to the board receiving brackets on both sides.
- (c) Fix the board fixing brackets (6) temporarily on the stand vertical supports (1) using the pan head screws (9).
- (d) Tighten the triangular knob screw (10) to fasten the board to the board fixing bracket (6) on both sides.
- (e) Tighten the pan head screws that were fixed temporarily in (c).

[3] Adjust the height

⚠ CAUTION

Be sure to use two or more people for this work.

Failure to comply may cause the board to fall, resulting in personal injury, or may cause damage to this product due to shock of impact.

The StarBoard can be positioned at six height levels. Adjust the height according to the following procedure. Note that this work should be performed by two or more people.

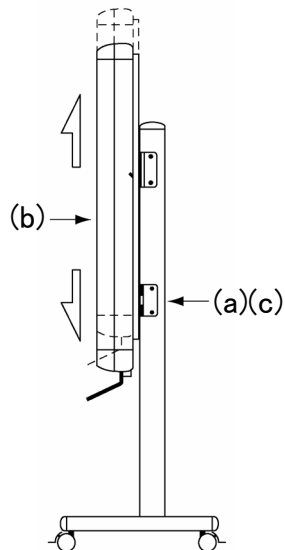

- (a) Remove the triangular knob screw at the bottom of each side.
- (b) Raise the board and attach the receiving brackets to the square holes at the desired height.
- (c) Tighten the triangular knob screw at the bottom of each side.

1.4.3 Pen Holder Setup Method

[1] Installation method

Insert the pen holder into the rail on the right side on the back of the board and slide it to the desired position.

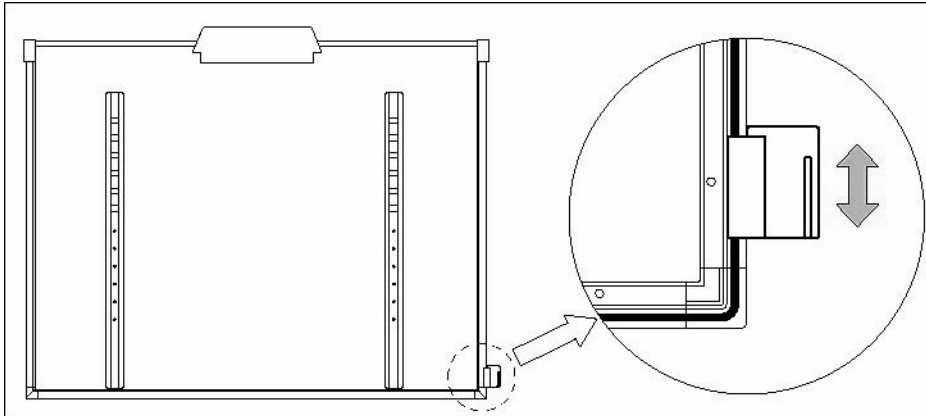

[2] Removal method

To remove the pen holder, apply pressure to the top of the pen holder and pull it back.

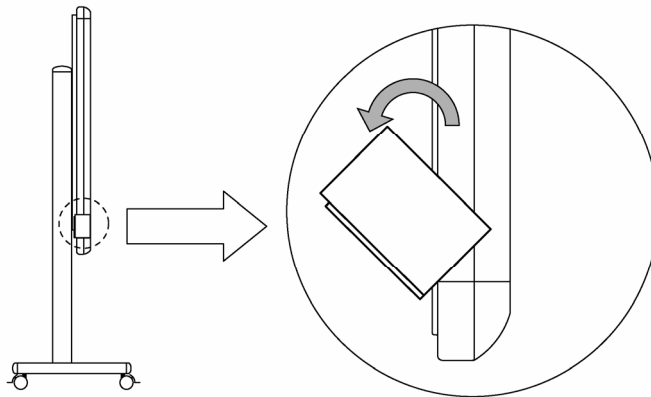

[3] To change the position of the penholder

- (a) Remove the installation part from the pen holder.
- (b) Insert the installation part into the opposite groove.
- (c) Insert the pen holder into the rail on the left side on the back of the board and slide it to the desired position.

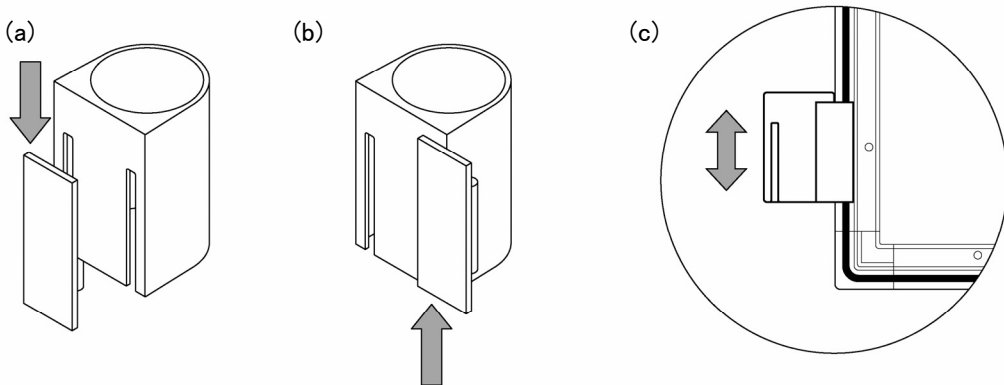

1.4.4 Equipment Connection Method

Before Starting to Connect Equipment

Install the StarBoard Software on your PC before starting to connect equipment. The equipment might not operate correctly if it is connected without the software being installed.

Connect the PC, projector and StarBoard according to the following procedure.

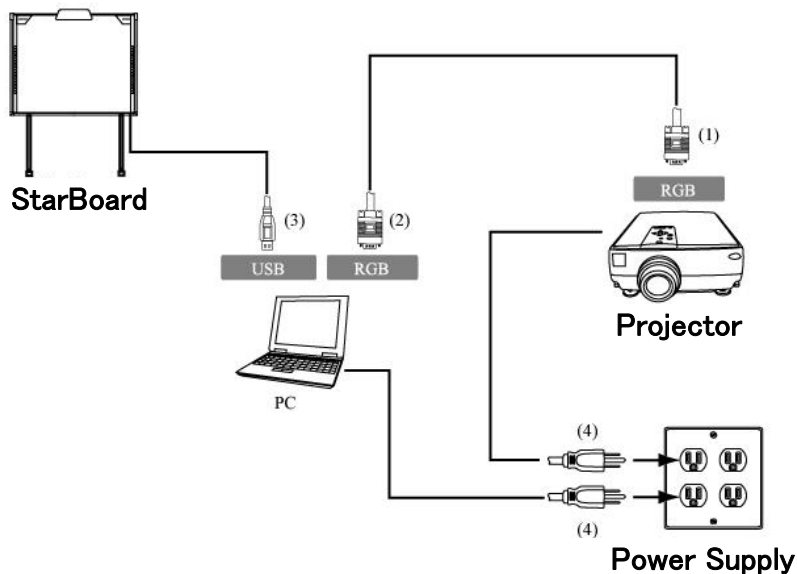

- (1) Connect the RGB cable to the projector's RGB connector, and fasten with screws.
- (2) Connect the opposite side of the RGB cable to the PC's RGB connector, and fasten with screws.
- (3) Connect the USB cable from the lower right of the StarBoard to a USB port on the PC.
- (4) Connect the power supply cables of the PC and projector to the power supply.

About PC Earth

Depending on your PC, an incorrect operation might be caused by PC noise via the USB cable. If this happens, verify that the earth of your PC's power supply cable is connected.

If the earth is not connected, it might cause an incorrect operation.

2. How to Use

2.1 How to Use Touch Mode

This section gives a basic description of how to use the board in touch mode.

2.1.1 Character Input

To input characters, use your finger or the stylus that was provided with the product.

NOTICE

Use an input tool with a thickness of least 7 mm.

When inputting to this product, use a tool that is at least 7 mm. If a pen or similar tool with a thickness of less than 7 mm is used, the input will be unstable.

Also, do not use tools with a sharp tip, such as a ballpoint pen. If such a tool is used incorrectly, it could damage the surface of the board.

– Using the stylus pen and Electronic pen

Use the pen on the board with your body kept sufficiently away, so that your palm and elbow do not touch the board. If your hand or elbow touches the board, or you are within 1 cm of the board, it might cause an incorrect operation.

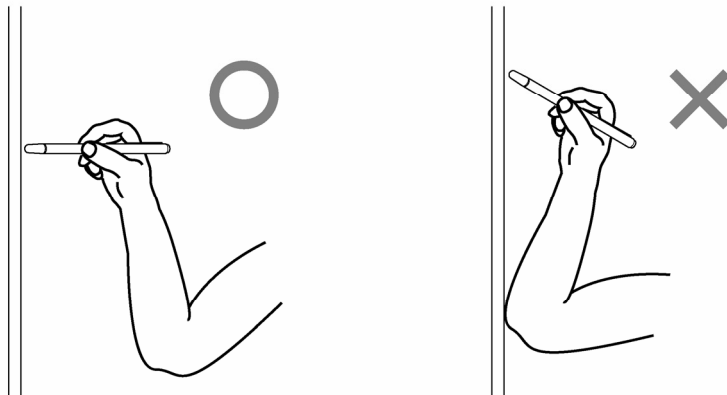

– Using your finger

Extend your finger and touch the board. In the same way as the stylus pen, if you touch the board with anything other than your finger or you are too close to the board, it might cause an incorrect operation.

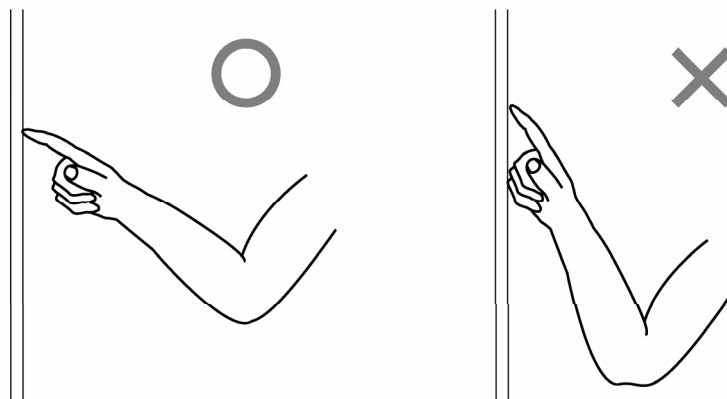

2.1.2 PC Operations

When performing PC operations by pointing or giving presentations without inputting characters, it is convenient to extend the stylus pen and use it as a pointer.

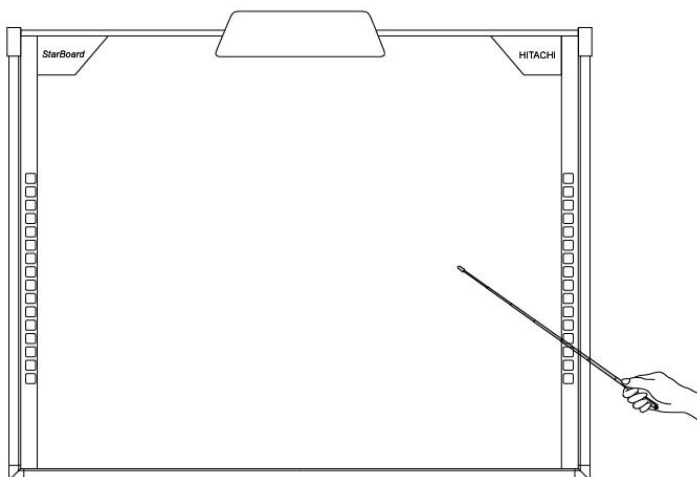

⚠ CAUTION

Do not strike the board forcefully with the stylus pen, bend it, or apply an excessive load to it.

Failure to comply may result in damage to the stylus pen or personal injury.

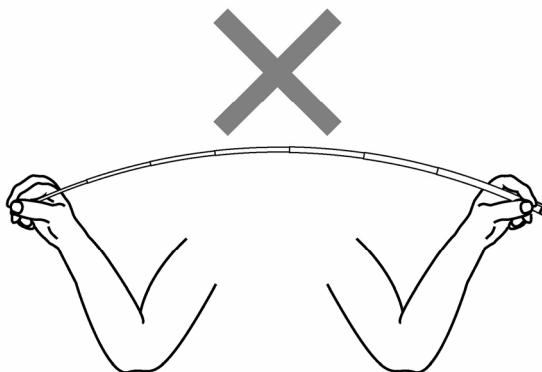

Important

Keep the stylus pen in the pen holder when not in use.

If you leave it on the reflective tape, it might cause a sensor error or incorrect detection.

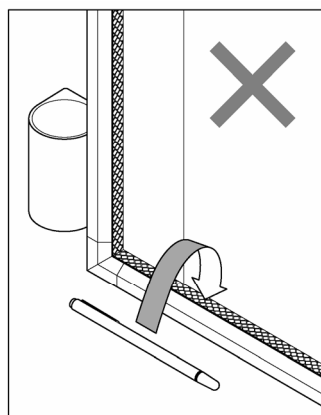
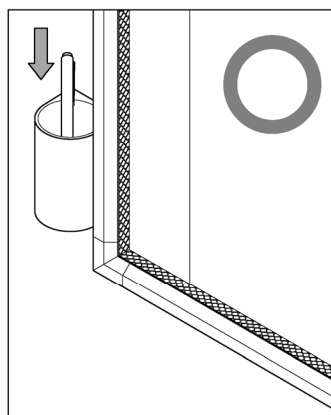

2.2 How to User the Electronic Pen

This section gives a basic description of how to use the electronic pen (option).

2.2.1 Inserting the Battery

Perform the preparations for using the electronic pen.

CAUTION

Be sure to install batteries correctly.

Do not install batteries with positive and negative terminals reversed, or use batteries other than the type specified. It will cause pen malfunctions and excess heat, or burns to the hand.

Be sure to provide insulation during disposal.

Be sure to insulate the positive and negative terminals of the battery using cellophane tape, or similar material when disposing of batteries. Disposing of batteries without insulating them may lead to overheating, bursting, or ignition due to shorting, resulting in personal injury or fire. Furthermore, be sure to follow all local rules and regulations regarding proper battery disposal. If within the EU, be sure to follow Batteries Directive.[Batteries directive (2006/66/EC)]

[1] Insert the battery into the electronic pen.

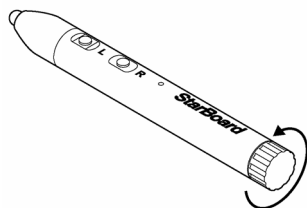

- (1) Open the battery cover by moving it in the direction of the arrow.

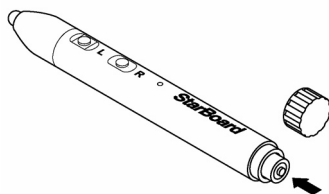

- (2) As shown in the figure, insert the AAA alkaline battery so that the + side faces the outside.

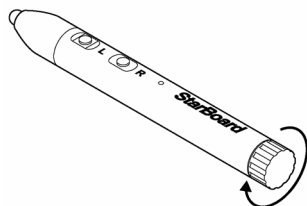

- (3) Close the battery cover by moving it in the direction of the arrow.

2.2.2 Using the Electronic Pen

To use the electronic pen to draw characters or images, place the tip of the electronic pen on the board and then move the pen. When you release the tip of the electronic pen from the board, the writing is complete. Be careful of the following two points when using the electronic pen.

- (1) When drawing with the electronic pen, keep the pen as perpendicular as possible to the board and apply force sufficient enough to cause the pen tip to retract into the electronic pen.
- (2) A miniature transmitter is embedded in the tip of the electronic pen. If you hold the transmitter area of the electronic pen while drawing characters or images, the drawing data from the electronic pen might not be transmitted correctly. If the characters or images drawn on the whiteboard are not imported correctly into the PC, change your grip on the electronic pen and then verify that they are displayed correctly.

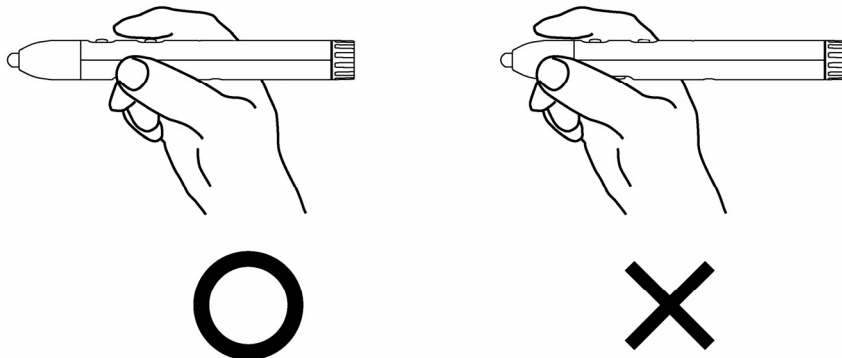

Blocking of the Infrared Beam

Electronic pen operations are detected when the digitiser reads the infrared beams that are generated by the pen. If the beam between the electronic pen and the digitiser is blocked, normal input becomes impossible. Avoid blocking them during use.

2.2.3 Basic Operations of the Electronic Pen

In the default setting of the electronic pen, the pen tip button is set to emulate the left click button of a mouse. While Windows is in operation, the following mouse operations can be performed using the pen tip button.

– Click

Push the pen tip onto the board with sufficient force and then quickly move the pen away from the board.

– Double click

Push the pen tip onto the board with sufficient force, and quickly move the pen away from the board two times in the same spot.

• Drag

Push the pen tip onto the board with sufficient force, and without releasing it away from the board, move it from one point to another.

2.2.4 Customizing the Electronic Pen

The electronic pen has one pen tip button and three side buttons. Mouse actions can be assigned to these four buttons.

The default button settings are shown in the following table.

| Button Name | Function |
|-----------------------|---|
| Pen tip | Left click |
| L (Side button No. 0) | Left double click |
| R (Side button No. 1) | Right click |
| C (Side button No. 2) | Hides/displays the StarBoard Software Toolbar |

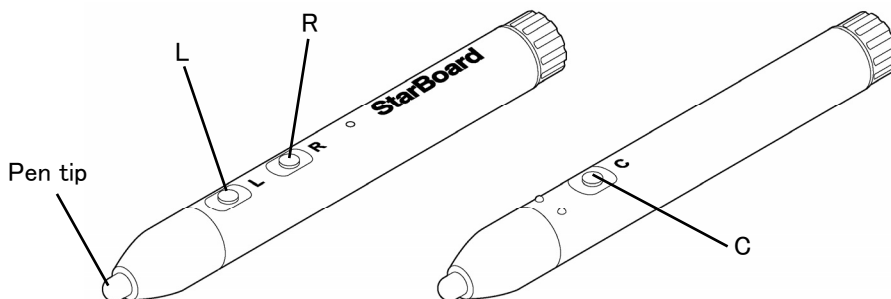

The side button settings can be changed. In the StarBoard Software Main Screen, select "Settings" → "Pen Settings" → "Configure Pen Buttons."

2.3 Start Method

2.3.1 Start Method

- (1) Connect the devices with reference to the connection method on page 1-15.
- (2) Turn on the power switch of the projector.
- (3) Turn on the power switch of the PC to start Windows.
- (4) Adjust the position of the projector so that the Windows screen projected by the projector is within the input area (refer to page 1-5 of this User's Guide).
- (5) Start the StarBoard Software. (StarBoard Software does not start when Windows starts unless [Startup] is selected in the shortcut creation step during the software installation process. In this case, start the StarBoard Software manually.)

Starting the StarBoard Software manually

Select [Start] → [Programmes] → [StarBoard Software] → [ StarBoard Software], or double click the StarBoard Software icon on the desktop. (A StarBoard Software icon will not be created on the desktop unless [Desktop] is selected in the

If the “No connection” icon in below appears on the Tasktray, it means that the StarBoard is not connected. Make sure that the StarBoard and the PC are properly connected.

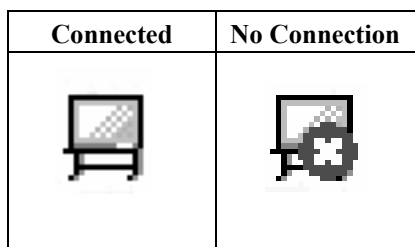

If the StarBoard is properly connected, the icon changes to “Connected” as above. If the icon does not change despite correcting the connection, there may be some other problem. For details, refer to “3. Appendix 3.1 Troubleshooting” on page 3-1 of this User’s Guide.

If the cursor location deviates from the pen tip, perform calibration. In the StarBoard Software Main Menu, select “Settings” → “Calibration” → “OK”. (Or “StarBoard” → “Settings” → “StarBoard” → “Calibration”, when using Toolbar Mode.)

- (6) Run "LsCanWiz.exe" located under "My Computer" → "C Drive" → "Program Files" → "Hitachi Software Engineering" → "FX-DUODriver", and adjust the sensor according to the instructions on pages 3-5.

| |
|---|
| Important |
| Conduct sensor adjustments upon first-time operations and whenever the board has been moved. |
| Not doing so may cause operation errors. |

3. Appendix

3.1 Troubleshooting

Before assuming the product is broken, be sure to check adjustments, proper handling procedures, the possibility of faulty cable connections, etc.

Recognition-Related Problems

| Problem | What to check | What to do |
|--|---|--|
| The StarBoard does not recognise input. | Is the USB cable connected to the PC? | Connect the USB cable to the PC. |
| | When viewing the central region of the digitiser storage area (page 1-5) from the bottom, is the LED lit green? | Check the USB cable connection. |
| | Did you start the system in the correct sequence? | Start the system in the correct sequence. (For details on starting the system, see page 2-7 of this User's Guide.) |
| | StarBoard Software files may be broken or installation may not be complete correctly. | Uninstall the StarBoard Software and then re-install it. (For details on installing StarBoard Software, see the StarBoard Software x.x User's Guide.) |
| | Other than the above | Contact a support center. |
| Touch Sensor Error (Something is blocking light from reaching the board surface or reflective tape. Or sensor adjustment is not properly. StarBoard can not detect the input.) | Is something blocking light from reaching the board surface or reflective tape? | Remove the blockage. |
| | Is the reflective tape dirty? | Wipe away any soiling on the reflective tape. |
| | Other than the above | Adjust the sensor. (See page 3-4 of this User's Guide.) |
| Touch Sensor Error (USB error) | The controller must be reset and the system restarted. | Disconnect the USB cable and reconnect it. If this does not solve the problem, restart the PC. |
| Touch Sensor Error (Insufficient USB bandwidth) | Is a high-speed USB device connected to the USB host controller used to connect the StarBoard? | Be sure to connect the StarBoard and any high-speed USB devices to separate USB host controllers. Be sure to use a USB hub in the case of PCs with only one USB host controller. |

Input-Related Problems

| Problem | What to check | What to do |
|--|---|--|
| The input position does not match. | Has position alignment been performed properly? | Perform proper position alignment. |
| | Other than the above | Contact a support center. |
| The position cannot be aligned properly. | Have the StarBoard and projector been placed in the proper orientation? | Adjust the position of the StarBoard and the projector. If undue correction is performed, it may not be possible to align the position properly. |
| | Is the PC screen being projected inside the StarBoard's input area? | Make sure the PC screen projection is contained within the StarBoard's input area. (For details on the input area, see page 1-5 of this User's Guide.) |
| | StarBoard Software files may be broken or installation may not be complete correctly. | Uninstall the StarBoard Software and then re-install it. (For details on installing StarBoard Software, see the StarBoard Software x.x User's Guide.) |
| | Other than the above | Contact a support center. |
| The electronic pen does not work. | This may be due to faulty contact of electronic pen batteries. | Remove the batteries from the electronic pen and re-install them. |
| | Are batteries used up? | Replace the batteries. (For details on battery replacement, see page 2-4 of this User's Guide.) |
| | StarBoard Software files may be broken or installation may not be complete correctly. | Uninstall the StarBoard Software and then re-install it. (For details on installing StarBoard Software, see the StarBoard Software x.x User's Guide.) |
| | Is there a nearby light source with a wavelength close to that of the electronic pen? (Illumination from fluorescent lighting or similar source) | Check by turning off the lights in the room. If the StarBoard operates normally, change the location in which it is installed or change the lighting fixtures. |
| | Other than the above | Restart Windows and StarBoard Software. Contact a support center. Check if the same problem arises when using another electronic pen. If operations are normal when using another electronic pen, the original pen is the problem. |

| Problem | What to check | What to do |
|--|---|---|
| Electronic pen operation is unstable or stops. | Is a remote controller for AV equipment being operated while using the pen? | Stop operating the remote controller. |
| | The battery charge of the electronic pen may be low. | Replace the batteries. (For details on battery replacement, see page 2-4 of this User's Guide.) |
| | StarBoard Software files may be broken or installation may not be complete correctly. | Uninstall the StarBoard Software and then re-install it. (For details on installing StarBoard Software, see the StarBoard Software x.x User's Guide.) |
| | Other than the above | Restart Windows and StarBoard Software. Check if the same problem arises when using another electronic pen. If operations are normal when using another electronic pen, the original pen is the problem. |

3.2 Adjusting the Sensor

3.2.1 Items to Check Before Making Sensor Adjustments

The following error may appear while using this product.

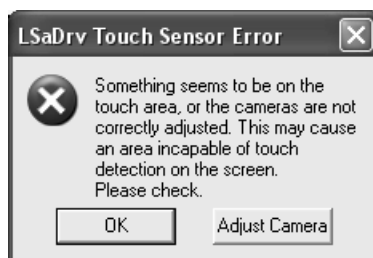

Check the following items if this error appears.

- Check that light is not blocked from reaching the board surface or reflective tape.
- Check that the reflective tape is not dirty.

If the problem is not corrected despite making the above checks, perform adjustments according to the steps given in item 3.2.2, "Sensor Adjustment Procedure."

3.2.2 Sensor Adjustment Procedure

- [1] Press the "Adjust Camera" button on the "LSaDrv Touch Sensor Error" dialog box displayed on the PC screen.

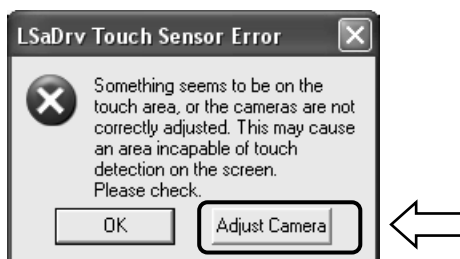

Manual Startup

In order to manually run the sensor adjustment wizard, open "My Computer" and execute "LsCanWiz.exe" located under "C Drive" → "Program Files" → "Hitachi Software Engineering" → "FX-DUODriver".

[2] "Camera Adjustment Wizard Start" window appears. Press "All Adjust."

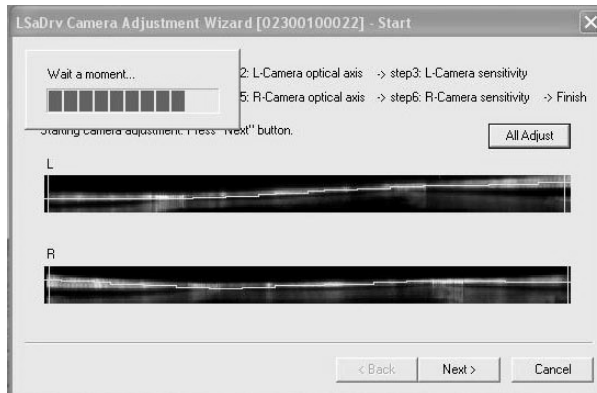
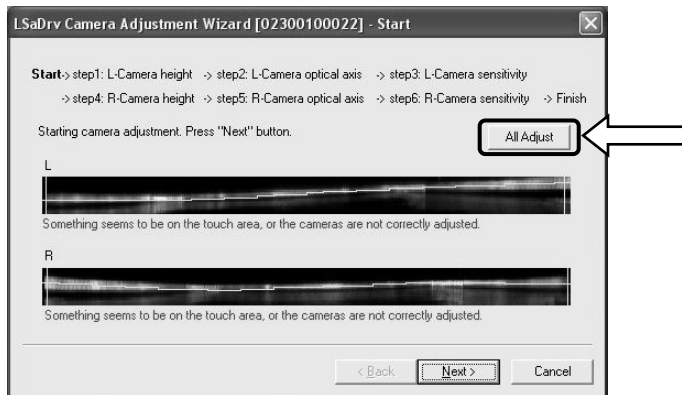

[3] Press "Finish"

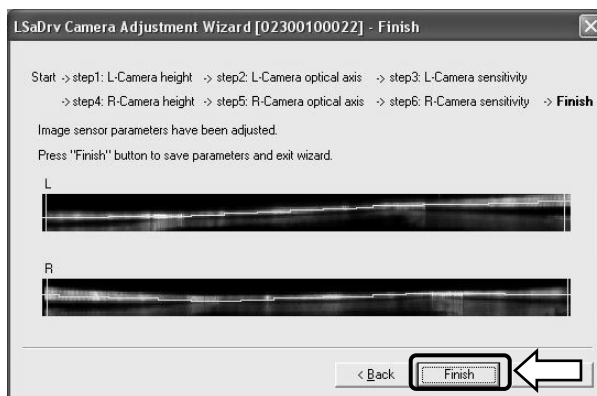

This completes sensor adjustment.

After making adjustments, check that input can be performed normally.

3.3 Regularly Auto Sensor Adjustment

While using StarBoard, auto sensor adjustment will execute regularly. To use StarBoard comfortably this function is recommended to use.

3.3.1 Sensor Auto Adjustment Procedure

[1] Confirmation message of auto sensor adjustment will be displayed after 7days passed from first connect of StarBoard to PC. If you press “Yes”, auto sensor adjustment program will execute. If you press “No”, this will not execute.

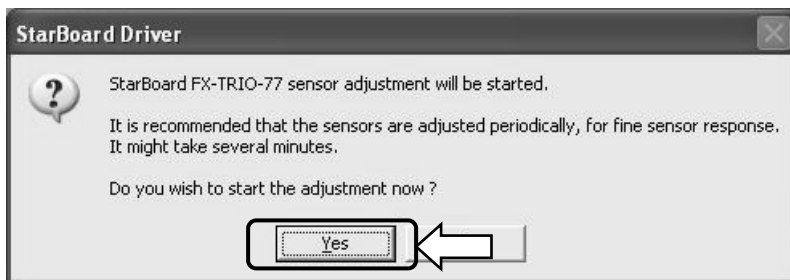

Manual execute

* Switch to PC Operation before Sensor Adjustment (Press the function button )
 For the manual execute, select “StarBoard” – “Setting” – “StarBoard” – “Pen Settings” and press “Sensor adjustment” in the StarBoard toolbar.

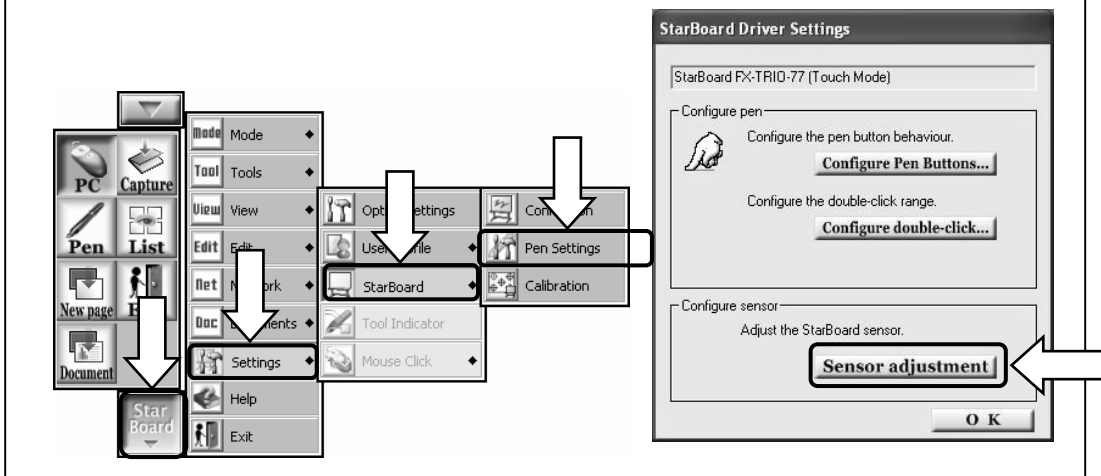

[2] Sensor adjusting screen will be displayed during auto adjustment. Do not touch the board surface until auto adjustment completed.



[3] Following window will be displayed when sensor auto adjustment finished. Press "OK".



This is all of auto sensor adjustment.
Confirm the normal input after adjustment

* In case of adjustment error, following window will be displayed. Press "Retry" to auto sensor adjustment program execute again.

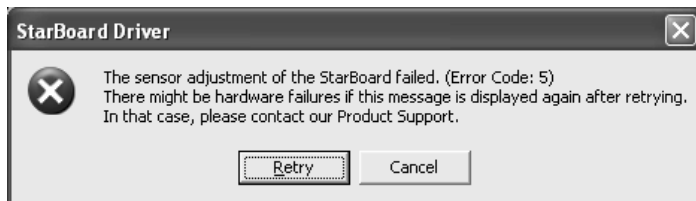

If this message displayed again, StarBoard may have some problem. Please Contact our support.

3.4 System Specifications

| Item | Specification |
|--|--|
| Model name | StarBoard FX-TRIO-77 |
| Detection method | Infrared image sensor system* ¹ |
| Digitiser resolution | 0.05mm |
| Sampling rate | Approx. 100 points/second when using (USB1.1 Full Speed) |
| Interface | USB 1.1 (cable length: 4.7m) |
| Effective screen size (mm) | Approx. 77inches、1,573(W) × 1,180(H) |
| Board dimensions (mm) | 1,765(W) × 1,408(H) × 69 (D) (not including the pen holder) |
| Overall dimensions (including stand) (mm) | 1,765(W) × 1,865~2,215(H) × 620(D) |
| Power consumption | 5V 500mA |
| Weight of main unit/ weight including stand | Approx. 28kg / 45kg |
| Operating requirements | +5°C – 35°C (Humidity: 20 – 80% RH, without condensation) |
| Storage requirements | -10°C – +45°C (Humidity: 20 – 80% RH, without condensation) |
| Electronic pen (option) | Communication system: Infrared (Carrier wavelength: 56 kHz, IR wavelength: 940 nm)* ² Side switches: 3 Power supply: AAA Expected battery life: Approx. 80 hours of continuous use* ³ (alkaline battery) Size: 149 mm × φ17 mm Weight: Approx. 20 g (not including batteries) |
| Standards, etc. | VCCI Class B, FCC Class B, CE |

*1 Using infrared and compact cameras, this product captures the image (shadow) of a pen or finger and detects the corresponding coordinate position. Do not operate near lighting that will obstruct the capture of the image. This includes:

- Locations where direct sunlight strikes the board surface or comes from the side.
- Locations with white incandescent lighting or strong infrared source directly overhead.

Depending on installation conditions or sensor property, position detection may be off by about 9 mm.

*2 The electronic pen uses infrared light having the same frequency (approx. 940 nm).

Do not operate this product in a location where other equipment (fluorescent lighting, plasma displays, passive sensors, etc.) may emit a similar frequency.

*3 The expected battery lifetime may vary depending on initial battery conditions, humidity, and the operating environment.

3.5 Proper Care and Cleaning

Clean the StarBoard periodically so that you may use it for a long time to come.

(1) Cleaning the StarBoard

- To clean the StarBoard, use a soft cloth dampened with whiteboard cleaner or a diluted neutral cleansing agent that does not contain a polishing compound.
- Never use a solvent such as thinner.
- Note that rubbing or striking the StarBoard surface with a finger nail or other hard object may result in scratching.

(2) Cleaning the reflective tape

If the reflective tape is dirty, it will affect pen or finger operations. Clean the reflective tape periodically or whenever it becomes dirty or soiled.

- To clean the reflective tape, apply a minimal amount of diluted neutral cleansing agent that does not contain a polishing compound to a soft cloth and wipe.
- Never use a solvent such as thinner.
- Use a soft cloth so that the surface of the reflective tape does not become scratched.

(3) Cleaning the electronic pen

- To clean the electronic pen, use a diluted neutral cleansing agent that does not contain a polishing compound. Do not apply the neutral cleansing agent directly, but rather dampen a soft wet cloth with a mixture of water and the cleaner, and wipe. Never use a solvent such as thinner.
- Do not allow the pen tip to get wet.

3.6 Replaceable Parts

- (1) Stylus pen
- (2) AAA alkaline battery
- (3) Spare pen tip

For details on obtaining them, contact your dealer or a support center.

3.7 Product Warranty Policy

1. During the free warranty service period, if a malfunction occurs during normal use, the malfunction will be corrected without charge, according to the provisions of the warranty. Furthermore, if the customer registration card accompanying the warranty is not returned to our company, the customer information will not be registered; so free repairs might be unavailable. After receiving this product, please immediately fill out and return this customer registration card.
2. The warranty coverage is listed in the following table:

| Product Name | Part Name | Warranty Coverage |
|----------------|-----------------------|-------------------|
| StarBoard | Digitiser | + |
| | Pen Holder | - |
| | Stylus Pen | - |
| | Function Area Sticker | - |
| | Reflective Tape | - |
| | Wall-Mounting Bracket | - |
| Electronic Pen | Electronic Pen | + |
| | AAA alkaline battery | - |
| | Spare Pen Tips | - |
| Stand | | - |

(Explanatory note): + → Covered by warranty (excluding wear or physical damage)
 - → Not covered by warranty

3. Please refer to the warranty sheet for this product's warranty service period.
4. Even during the warranty period, there will be a repair charge in the following cases:
 - (1) If the registration card accompanying the warranty is not returned to our company.
 - (2) If the warranty is not presented.
 - (3) If specified fields on the registration card accompanying the warranty are not completed, or if the wording has been changed without authorisation.
 - (4) The warranty applies only to the original purchasers. (It does not apply to a third party to whom the customer resold this product.)
 - (5) In the event of a malfunction or damage resulting from the customer's improper handling (e.g., a fall, impact, etc., caused by the customer during transportation or movement).
 - (6) In the event of problems resulting from handling contrary to the handling and precautions mentioned in this user's guide.
 - (7) In the event of failure or damage resulting from abnormal voltages, pollution or other natural disasters (e.g., fire, earthquake, and lightning).
 - (8) In the event of a malfunction in this product caused by the connection to this product

- of equipment other than the equipment specified by our company.
- (9) In the event that there is no abnormality in this product, but a defect in a part other than this product was detected or remedied.
 - (10) In the event of ordinary wear and tear, wear, deterioration, etc., of consumables, even during normal use.
5. If this product malfunctions, review the contents of this user's guide. If the problems remain irreparable, contact the dealer. The dealer will determine whether or not the product must be repaired, so please contact them. If the customer sends the product to our company without RMA (Return Merchandise Authorisation) number, it might not be covered by warranty.
6. As a rule, the customer is responsible for shipping charges required to send all or part of the product for repair, etc. Our company will assume responsibility for the return shipping to the customer.
7. This warranty does not cover labour fees for repair-associated equipment assembly or disassembly.
8. Incidental damage caused by the failure of this product (e.g., loss of profit that should have resulted from the use of this product) is outside the scope of this warranty.
9. The aforementioned provisions define this warranty, and they supersede those of all express or implied warranties that include legal defect liability.
10. This warranty is limited to use of this product within the country where the user bought this product.