



MAGICBOX™



Torque

Cordless DECT telephone with answering machine





TABLE OF CONTENTS

Welcome	3	To adjust the volume	11
Product set up	4	Secrecy	11
Handset range	4	To end a call	11
Signal strength	4	To switch the handset on/off	11
Setting up the base and handset	5	Mood lighting	12
Handset battery low warning	6	Using the phonebook	13
Handset battery performance	6	Using text messaging	17
Date and time	6	Using the calls list	23
Set the date and time manually	7	Using the agenda	26
Product set up	4	Clock & alarm	29
Your Torque handset	8	Handset settings	30
Your Torque base	9	Base settings	33
Using the handset	10	Registration	45
To make a call	10	Answering machine	38
To make a call by pre-dialling	10	Simple solutions	45
Call from the phonebook	10	General information	50
Call from the calls list	10	Warranty	52
Answer a call	11	Technical information	54
Handsfree	11		



WELCOME

to your Torque cordless DECT phone with full touch sensor keypad.

This user guide provides you with all the information you need to get the most from your Torque handset and answering machine.

Before you use your product or make your first call, please read the important information on this page.

IMPORTANT NOTE:

Your Torque handset has a high quality full touch sensor keypad, which is much more sensitive than a normal telephone keypad. It provides very fast and responsive keying, however like most new technology it can take a little time to get used to using it.

Some tips to help you get the best from your phone quickly are:

- Pick the handset up by the sides, touching the area just below the front black touch sensor panel, then cradle the back of the handset in your hand whilst you dial.

- During use, avoid touching the keypad area unnecessarily to prevent accidental triggering of the keypad.
- The keypad will automatically disable when you hold the receiver to your ear to reduce the risk of accidental keypad presses while the handset is held against the side of your face.
- To 'wake' the keypad to enable you to dial further digits, e.g. if you want to access the menu, you just need to take the handset away from your ear and wait for the backlight to come on. You can then dial normally.
- It is very easy to tell when the keypad is disabled, as the keypad backlight will be off.
- When dialling digits to select from a voice menu, e.g. Press 1 for accounts..., please ensure that you hold the handset away from the display area.
- Holding the handset at the top around the display area may activate the secrecy feature.



PRODUCT SET UP

Where to place your product

It is important that you consider carefully in advance where your Torque base and cordless handset will be situated and make sure that they are:



- * on a flat and stable surface
- * within 1.8 metres of a power socket and telephone socket
- * at least 1 metre away from other electrical appliances to avoid any interference
- * away from bright sunlight or heat sources, such as a radiator
- * not in a humid or very damp place such as a bathroom

Note: Your Torque product works by sending radio signals between the handset and the base. The strength of the signal depends on where you site the base. Putting it as high as possible ensures the best signal.

Handset range

The Torque handset has a range of 300 metres outdoors when there is a clear line of sight between the base and the handset. Any obstruction between the handset and the base will reduce the range significantly. With the base indoors and the handset either indoors or outdoors, the range will normally be up to 50 metres. Thick stone walls can severely affect the range.

Signal strength

The  icon on your handset indicates when you are in range. When out of range of the base, Searching... is displayed and the  icon will flash.

If you move out of range during a call, the telephone call will be disconnected. Move back within range before you make any further calls. The handset will automatically re-connect to the base.



PRODUCT SET UP

IMPORTANT

Only use the mains power adaptor and telephone line cord supplied with the product.

This equipment is not designed for making emergency telephone calls when the power fails. Alternative arrangements should be made for access to emergency services.

Setting up the base and handset

1. Plug the power adaptor and telephone cable into the underside of the base.
2. Plug the power adaptor into the mains wall socket and switch the power on.
3. Remove the battery cover from the back of the handset and insert the 2 x AAA rechargeable batteries supplied. Please note the '+' and '-' markings inside the battery compartment and insert the batteries the correct way around. Slide the battery compartment shut.

WARNING

Never use non-rechargeable batteries. Only use the approved rechargeable batteries supplied. Using unapproved batteries will invalidate your guarantee and may damage the telephone. If you are unsure, please call the helpdesk on 0845 833 1673.

4. Place the handset onto the base to charge for at least 24 hours. Your Torque handset has 'reverse charging' and so can be placed either way around on the base. Check that the round connector on the back of the handset is in contact with the round connector in the middle of the base. When the handset is fully charged the battery icon in the top right of the display will indicate this.
5. After 24 hours, plug the telephone line cord from the Torque base into the telephone wall socket.

Torque multipack users only:

Place each Torque charger within reach of a mains power wall socket.

1. Plug the mains power adaptor into the power socket on the underside of the charger and plug the other end into the mains power wall socket.





PRODUCT SET UP

2. Insert the 2 x AAA rechargeable batteries supplied, taking note of the '+' and '-' markings inside the battery compartment, then slide the battery compartment shut.
3. Place the handset on the charger. Your Torque handset has 'reverse charging' and so can be placed either way around on the base or charger. Check that the round connector on the back of the handset is in contact with the round connector in the middle of the charger. You should let the batteries charge continuously for at least 24 hours.

The display will show the handset number, e.g. 2, to show it is registered to the base.

Handset battery low warning

If the  icon flashes in the display, you will need to recharge the handset before you can use it again. During charging, the  icon in the display will scroll.

Handset battery performance

In ideal conditions, fully charged batteries should give about 10 hours talk time or 100 hours standby time on a single charge.

Note that new batteries do not reach full capacity until they have been in normal use for several days.

To keep your batteries in the best condition, leave the handset off of its charger base for a few hours at a time.

Running the batteries right down at least once a week will help them last as long as possible.

The charge capacity of rechargeable batteries will reduce with time as they wear out, giving the handset less talk/standby time. Eventually they will need to be replaced.

The batteries and handset may become warm during charging. This is normal.

Date and time



Providing you have subscribed to your network's Caller Display service, the date and time is set automatically every time a call is received.

If you do not subscribe to the Caller Display service or would like to set the correct time and date straight away, you can set the date and time manually.



PRODUCT SET UP

Set the date and time manually

1. On the handset press the button with the line on it, under 'Menu' on the display. Scroll  to 'Clock & Alarm'. Press 'Select'. 'Date & Time' will be displayed, then press 'Select' again. 'Please wait....' will be displayed for a few seconds.
2. Using the keypad, enter the date using the format DD-MM-YY e.g. 04-08-10 for 4th August 2010.
3. Press 'Save' and enter the time using the 24 hour format HH-MM, e.g. 14-45 for 2.45pm.
4. Press 'Save' to confirm or  RED to return to standby.

Your Torque handset is now ready for use.



YOUR TORQUE HANDSET

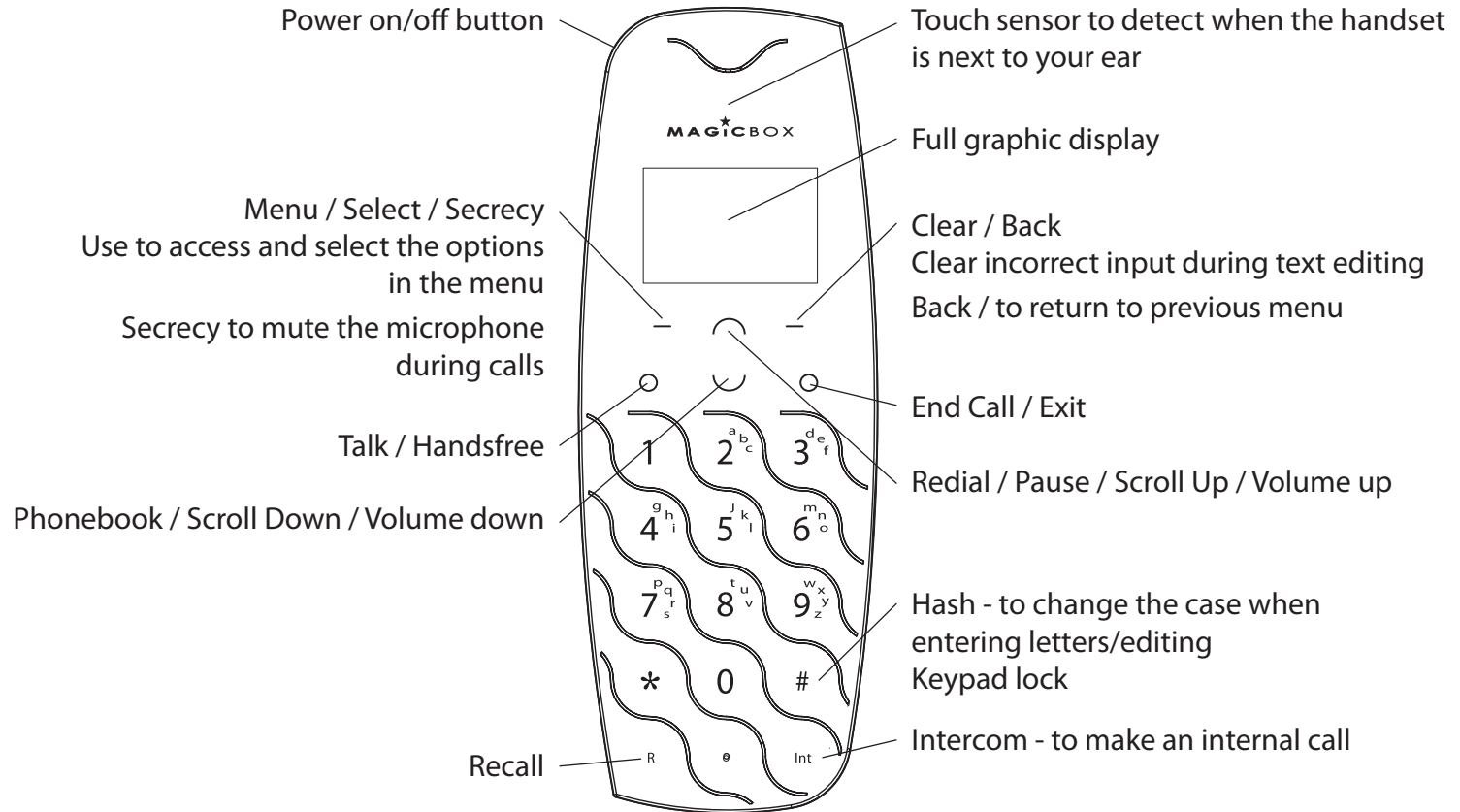



YOUR TORQUE BASE

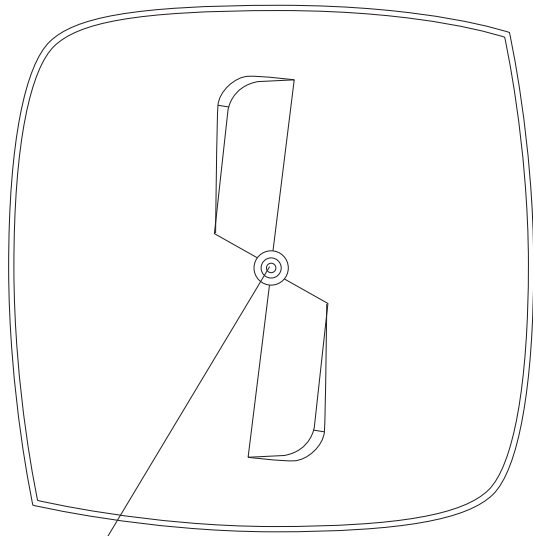

Reverse charging contact, handset can be placed either way around on the base

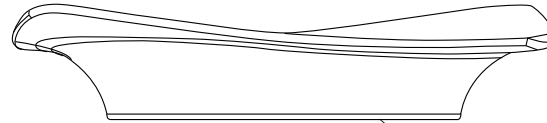

Page / Find handset key
Use to turn mood lighting on / off

Mains power socket

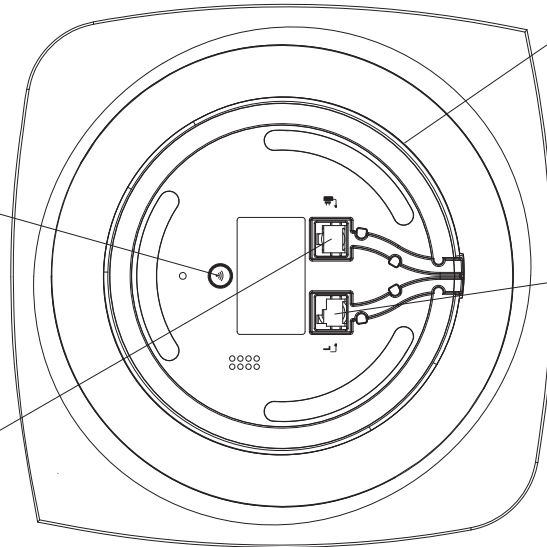

Mood lighting on the base to indicate incoming calls, new SMS and answering machine messages

Telephone line socket





USING THE HANDSET

To make a call

1. Press GREEN.
2. Dial the telephone number.

To make a call by pre-dialling

1. Enter the phone number (maximum 24 digits).
If you make a mistake press 'Clear'.
2. Press GREEN to dial the phone number entered.

Call from the phonebook

NOTE

You will first need to add new entries to the phonebook. See page 13.

1. Press . The first entry in the phonebook is displayed.
2. Scroll up or down to the entry you want.
3. Press GREEN to dial the number.

TIP

Instead of scrolling to browse the phonebook entries, press the numeric key corresponding to the first letter of the entry you wish to locate. For example, pressing 2 will show the entries starting with A. Pressing 2 again will show the entries starting with B, etc...

Call from the calls list

NOTE

You need to subscribe to your network's Caller Line Identification service to be able to see the caller's number in the calls list.

1. Press 'Menu', scroll to 'Calls Lists' and press 'Select'.
2. Use the or to highlight 'Missed', 'Received' or 'Dialled' calls. Press 'Select'.
3. Scroll or to the entry you want.
4. Press GREEN to dial the number.



USING THE HANDSET

Answer a call

1. When the phone rings , press **O GREEN** to answer the call. When answering the handset from the charger base with 'Auto Talk' set to On, nothing needs to be pressed.



Handsfree

1. When the phone rings , press **O GREEN** twice to answer the call in Handsfree mode. You can press **O GREEN** each time you wish to switch between handset and handsfree mode.

WARNING

When the phone is ringing, avoid holding the earpiece too close to your ear as it may damage your hearing. Handsfree activation can suddenly increase the volume in the earpiece to a very high level. Make sure the handset is not too close to your ear.

To adjust the volume

1. During a call, press  or  to adjust the earpiece or loudspeaker volume. The level is shown in the handset display.

Secrecy

Use the secrecy feature when you would like to speak to someone else in the same room as you, without your caller hearing you.

1. During a call, press 'Secrecy'. 'Secrecy On' is displayed.
2. Press 'Off' again to turn the microphone back on and speak to your caller again.

To end a call

1. Press **O RED**.

After you hang up, the duration of your call is displayed for 5 seconds.

To switch the handset on/off

1. Press and hold the small power button on the top left of the handset, just beneath the black touch panel.
2. Press and hold the small power button again to switch the handset back on.



USING THE HANDSET

Mood lighting

Your Torque base has 'Mood lighting' which is a ring of white light around the circular area of the base, where it sits on a surface. This light will flash when you have a new incoming call, when you make a call and when you receive new SMS or answering machine messages.

To turn the mood lighting on/off.

1. Press and hold the page button ●))) on the underneath of the base for 5 seconds. You will hear 2 beeps. Continue to hold the page button ●))) until the Mood light switches on or off as appropriate.



USING THE PHONEBOOK

The Torque handset phonebook can store up to 100 names and numbers.

NOTE

Numbers can be up to 24 digits long and names up to 12 characters long. Entries are stored in alphabetical order.

To view and dial phonebook entries

1. Press \curvearrowright . Display shows the first entry.
2. Scroll \curvearrowleft or \curvearrowright to the entry you want. Or to search alphabetically, press \curvearrowright then press the key with the first letter of the name, e.g. if the name begins with N, press 6 twice. The display shows the first entry beginning with N. If required, press \curvearrowleft or \curvearrowright to scroll to the exact entry.
3. Press 'Options', then scroll \curvearrowright to 'Show Details'. Press 'Select'.
4. Press \circ GREEN or 'Dial' to dial the entry displayed.
5. Press \circ RED to end the call (if dialled), or return to standby.

To view an entry during a call:

1. Press 'Names' to open the phonebook menu.
2. Enter the first letter of the name you want then scroll \curvearrowleft or \curvearrowright if necessary to the exact name.
3. Press 'Options', then scroll \curvearrowright to 'Show Details'. Press 'Select'.
4. Press 'Back' to cancel the Phonebook display.
5. Press \circ RED to end the call.

To add an entry

1. Press 'Names'. Scroll \curvearrowright to highlight 'Add Entry'.
2. Press 'Select'. 'Enter Name:' is displayed.
3. Enter a name using the keypad and press 'OK'.
4. Enter a number. Press 'OK' to save. Use the \curvearrowleft or \curvearrowright to select a melody and press 'Select' to confirm.
5. Press \circ RED to return to standby.

Enter a pause

If your Torque handset is connected to a switchboard, you may need to enter a pause in a stored number.



USING THE PHONEBOOK

This gives the switchboard time to find an outside line. A Pause is normally stored after the switchboard access code (e.g. 9)

1. When storing a number, press and hold  until the display shows 'P'. You can then continue storing the phone number.

NOTE

You can cancel storing an entry at any time during the process by pressing  RED to return to standby.

Entering characters/names

Use the alphanumeric keypad to enter names in the phonebook.







For instance to enter the name Paul:

- P Press '7' once
- A Press '2' once
- U Press '8' twice
- L Press '5' three times

To enter a space press '0'

Press 'Clear' to 'Delete' a character.

To edit an entry

1. Press .
2. Scroll  or  to the entry you want to edit and press 'Options'. Scroll  to 'Edit Entry' and press 'Select'.
3. Edit the name and press 'OK' to confirm. Press 'Clear' to 'Delete' characters.
4. Press 'OK' and edit the number.
5. Press 'Save' to confirm.
6. Use the  or  to select a melody and press 'Select' to confirm.
7. Press  RED to return to standby.

To change a ringtone







You can change a ringtone assigned to a phonebook entry, quickly and simply.

1. Press .











USING THE PHONEBOOK

2. Scroll  or  to the entry with the ringtone you want to change and press 'Options'. Scroll  to 'Ringtone' and press 'Select'.
3. Use the  or  to select a different melody and press 'Select' to confirm.
4. Press  RED to return to standby.

To copy an entry (multipack users)





If you purchased a Torque multipack with more than 1 handset, you can copy Phonebook entries to the other handset/s

1. Press .
2. Scroll  or  to the entry you want to copy and press 'Options'. Scroll  to 'Copy Entry' and press 'Select'. 'To Handset' is displayed. Press 'Select'.
3. The other handsets registered to the base are displayed, e.g. Handset 2. Use the  or  to select the handset that you would like to copy the entry to and press 'Select' to confirm. 'Please wait...' is displayed.

4. On the receiving handset, e.g. Handset 2., 'Copy Phonebook?' is displayed. Press 'Yes' to accept or 'No' to reject the phonebook entry.
5. Press  RED to return to standby.

To copy all entries (multipack users)

If you purchased a Torque multipack with more than 1 handset, you can copy all the Phonebook entries from 1 handset to the other handset/s



1. Press 'Names'.
2. Scroll  to 'Copy Phonebook' and press 'Select'. 'To Handset' is displayed. Press 'Select'.
3. The other handsets registered to the base are displayed, e.g. Handset 2. Use the  or  to select the handset that you would like to copy the entries to and press 'Select' to confirm. 'Please wait...' is displayed.
4. On the receiving handset, e.g. Handset 2., 'Copy Phonebook?' is displayed. Press 'Yes' to accept or 'No' to reject the phonebook entries.
5. Press  RED to return to standby.







USING THE PHONEBOOK

To Delete an entry

1. Press .
2. Scroll to the entry you want to 'Delete' and press 'Options'.
3. Scroll  to 'Delete Entry' and press 'Select'.
4. Display shows 'Delete?' and the name of the entry. Press 'Yes' to confirm or 'No' to return to the options.
5. Press  RED to return to standby.

To Delete all entries

1. Press 'Names'.
2. Scroll  to 'Delete' Phonebook' and press 'Select'.
3. 'Delete All Entries?' is displayed. Press 'Yes' to confirm or 'No' to return to the options.
4. Press  RED to return to standby.

Memory status

You can check how many phonebook entries you have saved on your handset and how many entries you still have available.

1. Press 'Names'.
2. Scroll  to 'Memory Status' and press 'Select'. The following information will be displayed, this is an example if only 3 phonebook entries have been saved:

Memory Used: 3

Memory Free: 97
3. Press  RED to return to standby.



USING TEXT MESSAGING

Your Torque handset can send and receive text messages from participating mobile networks and compatible landline telephones in the UK.

The fixed line text service is provided under BT's terms and conditions for telephone service. These can be found by visiting the BT.com website at: <http://www.bt.com/terms>

Total number of messages

Your handset can store up to a total of 50 short messages across all handset Outbox, Draft and Inboxes.

Memory full alert

If the text mailboxes are full when you attempt to write a new message the display shows Memory Full Delete Messages for 2 seconds. You must delete messages before you can write and send a new one.

Subscribe to the 'Text Messaging' service

When you send your first text message from your handset you will automatically be registered for the service.

You must subscribe to your Network Provider's Caller Display service so that you can use Text Messaging and you must not withhold your telephone number. On most networks if you normally withhold your number the 1470 prefix will present your number for you.

A quarterly fee may be payable, please contact your telephone network provider for more details.

You may also send messages to landline phones that are NOT text compatible. Messages to non-compatible lines will be connected to voice text and delivered in spoken words.

The fixed line text service is provided under BT's terms and conditions for telephone service. These can be found by visiting the BT.com website at: <http://www.bt.com/terms>.

Cost of the fixed line Text Messaging service

There is no subscription charge (other than the subscription to Caller Display). Visit the BT.com website (www.bt.com) to find out how much it costs to send a text message.





USING TEXT MESSAGING

Send a text message

1. Press 'Menu,' 'Text Messaging' is displayed, press 'Select'.
2. 'Write Message' is highlighted. Press 'Select'.
3. Use the keypad to enter your message.

The maximum number of characters in a text message is 160.

Press # to switch between upper case ABC, lower case abc letters and digits.



4. Press 'Options.' 'Send' is highlighted. Press 'Select' to send the message. Enter the phone number or press 'Search' to open the phonebook, then scroll to the number you want and press 'Select.' Now press 'Send'.

You can also scroll  or  to:



SAVE

Press 'Select' to save the message in the Drafts folder.



INSERT SYMBOL

Press 'Select.' The symbol table is displayed. Press  or  to highlight the symbol you want and then press 'Insert'.





INSERT EMOTICON

Press 'Select.' The Emoticon table is displayed. Press  or  to highlight the Emoticon you want then press 'Insert'.

INSERT TEMPLATE

Press 'Select.' The list of Templates is displayed. Press  or  to highlight the Template you want then press 'Insert'.

NOTE

If you select 'Send Message' from within the Phonebook menu, the phone number of the person you are sending the text to will be entered for you. (Press , scroll  or  to the entry you want to send the text to. Press 'Options.' Scroll  to 'Send Message' and press 'Select'.

5. When Sending a message, 'Sending Message' will be displayed, followed by 'Message Sent'.





USING TEXT MESSAGING

Standard text entry



With standard text entry you can enter a word by pressing each letter button a number of times to display the character you want. For example: to write the word 'Hello', press 4 twice, 3 twice, 5 three times, 5 three times and 6 three times.

Receiving and reading text messages

When you receive a new text message, an icon is displayed on the handset as well as 'You have X new message/s' on the handset display.

If 'Mood lighting' is switched on, this will also flash on the base.

Read a new message







1. Press 'Read', the inbox is opened and the list of messages is displayed. If you press 'Back' the message is stored in the Inbox for reading later.
2. In the Inbox scroll  (to more recent messages), or  (to older messages) through the list of messages.
3. Highlight the message you want to read and press 'Read' or press 'Back' to return to the Text Messaging Menu.
4. Press  RED to return to standby.

NOTE

If you are writing a text and you receive a call the text will be lost.

Read, forward, delete, view and save numbers of texts in the Inbox.

When you see the new message alert, if you press 'Back' the message is stored in your Inbox so that you can read it later.

1. Press 'Menu', 'Text Messaging' is displayed, press 'Select'. If you have new messages you will go straight to the Inbox, if not scroll  to Inbox and press 'Select'.
2. Scroll  or  to the message you want to read and press 'Read'. Scroll  or  through the message.
3. Press 'Options' and scroll  or  to:

REPLY

Press 'Select', write your reply then press 'Options' and select 'Send'.

FORWARD



Press 'Select'. The message is displayed. Press 'Options', 'Send' is highlighted. Press 'Select' and enter a number or search for the number and then press 'Send'.

USING TEXT MESSAGING

MESSAGE DETAILS

You can see who sent the message and then call them. Press 'Select', the 'Sender's number is displayed. Press 'Dial' if you want to call the number.



USE NUMBER

To call the sender, press 'Select'. 'Call' will be displayed. Press 'Select' to call the sender OR to save the number, scroll  to 'Save' and press 'Select'. Enter a name and press OK, edit the number if required then press 'Save'. Scroll  or  to the ringtone and press 'Select'. The number is saved in the phonebook.









'Delete'

Press 'Select'. Press 'Yes' to confirm or 'No' to cancel.









Edit or send texts in the Drafts box

1. To open the Drafts box, press 'Menu', 'Text Messaging' is displayed. Press 'Select'.
2. Scroll  to 'Drafts' and press 'Select'.
3. Press 'Edit' to edit your message content.
4. Press 'Options' and scroll  or  to 'Send', 'Save', 'Insert Symbol', 'Insert Emoticon', 'Insert Template' or 'Message Type'.

Forward or 'Delete' texts in the Outbox





1. To open the Outbox, press 'Menu', 'Text Messaging' is displayed. Press 'Select'.
2. Scroll  to 'Outbox' and press 'Select'.
3. Scroll  or  to the message you want and press 'Read'. Scroll  or  through the message.
4. Press 'Options' and scroll  or  to 'Forward' or 'Delete'.
5. Press  RED to return to standby.

Edit templates

1. Press 'Menu', 'Text Messaging' is displayed. Press 'Select'.
2. Scroll  to 'Templates' and press 'Select'.
3. Scroll  or  to the template you want to edit and press 'Options'. Scroll  or  to 'Edit' and press 'Select'.
4. Use the  or  to scroll through the template, together with the keypad and 'Clear' to edit the template. Press 'Save'.
5. Press  RED to return to standby.

USING TEXT MESSAGING

Deleting texts

1. To open the Drafts box, press 'Menu', 'Text Messaging' is displayed. Press 'Select'
2. Scroll  to 'Delete Messages' and press 'Select'.
3. Scroll  or  to 'Inbox', 'Drafts', 'Outbox' or 'All Messages' and press 'Select'.
4. Press 'Yes' to confirm or 'No' to cancel.
5. Press  RED to return to standby.







Service centre numbers

To send and receive text messages you need the telephone number of your Network's text centre, these are already stored in your handset but if you accidentally 'Delete' the Outgoing or Incoming Service Centre numbers, you will need to re-enter them in order for your text service to work. You can enter up to 4 Service Centre numbers - two incoming and two outgoing.





The 'Send' Centre number is: 1470P1709400.

The Receive Centre number is: 080058752.

Add or change Service Centre numbers

1. Press 'Menu', 'Text Messaging' is displayed. Press 'Select'. Scroll  or  to 'Text Settings' and press 'Select'.
2. 'Service Centres' is highlighted, press 'Select'.
3. Scroll  or  to 'Receive Centres' or 'Send Centres' and press 'Select'.
4. Scroll  or  'Centre 1' or 'Centre 2' and press 'Select'.
5. Enter the number for the centre and press 'Save'.
6. Press  RED to return to standby.







Set send centre

1. Press 'Menu', 'Text Messaging' is displayed. Press 'Select'. Scroll  or  to 'Text Settings' and press 'Select'.
2. 'Service Centres' is highlight, press 'Select'.
3. Press 'Select' again to choose 'Set Send Centre'.
4. Scroll  or  to 'Send Centre 1' or 'Send Centre 2' or 'Send Centre 1' or 'Send Centre 2' and press 'Select'.
5. Press  RED to return to standby.







USING TEXT MESSAGING

Message alert tone

1. Press 'Menu,' 'Text Messaging' is displayed. Press 'Select.' Scroll  or  to 'Text Settings' and press 'Select.'
2. Scroll  to 'Message Alert' and press 'Select'
3. Scroll  or  to 'On' or 'Off' and press 'Select.'
4. Press  RED to return to standby.

Set message size

1. Press 'Menu,' 'Text Messaging' is displayed. Press 'Select.' Scroll  or  to 'Text Settings' and press 'Select.'
2. Scroll  to 'Message Size' and press 'Select'.
3. Scroll  or  to highlight 160 or 612 characters, then press 'Select'.

NOTE

A standard text message is 160 characters long. You can set a message to be up to 612 characters and the message will be sent as up to 4 linked messages, each up to 160 characters long.

USING THE CALLS LIST

If you have subscribed to Caller Line Identification (CLI), and provided the identity of the caller is not withheld, the number of the caller will be displayed on your handset when you receive an incoming call.

NOTE

If the caller's number is stored in your phonebook along with a name, the name will also be displayed. If the telephone number is not available for incoming calls, 'Unavailable' will be displayed.

Information about incoming calls will vary by country and network operator. Some operators may charge a subscription for their Caller Line Identification service.

The calls list contains details of missed, received and dialled calls. Details include the date and time of the call. Entries are displayed in chronological order with the most recent call at the top of the list.



When the calls list is full, a new call replaces the oldest in the list.



The handset can hold details of up to 30 answered or unanswered calls and 20 dialled Calls.

If you receive more than one call from the same number, only the most recent call is kept in the calls list.

When you have 'Missed Calls' (incoming calls that you haven't answered) the display shows 'You have X 'New missed calls'. If 'Mood lighting' is switched on, this will also flash on the base. If you press 'Back', the screen returns to standby and the missed call icon is displayed.

To view the calls list

1. When you see 'New missed calls' displayed press 'View'. You can now scroll  or  through the 'Missed Calls' list.







Alternatively, if you pressed 'Back' and the screen is at Standby. Press 'Menu', Use the  or  to scroll to 'Calls Lists' and press 'Select'. 'Missed Calls' will be highlighted, press 'Select' to view the calls list.

2. Press 'Options', 'Show Details' is highlighted. Press 'Select' to see the details.
3. Press  RED to return to standby.











USING THE CALLS LIST

To dial from the calls list







1. Press 'Menu', scroll  to 'Calls Lists' and press 'Select', 'Missed Calls' is highlighted. Scroll  or  to choose 'Missed Calls', 'Received Calls' or 'Dialled Calls'.
2. Press 'Select'. You can now scroll  or  through the list.
3. Press 'Options', 'Show Details' is highlighted. Press 'Select' to see the Caller's details.
4. Press 'Dial' to call the number.
5. Press  RED to end the call.

To save a number from the calls list to the phonebook

1. Press 'Menu', scroll  to 'Calls Lists', then press 'Select', 'Missed Calls' is highlighted. If required, scroll  or  to 'Received' or 'Dialled' Calls then press 'Select'.
2. Scroll  or  to the entry you want and press 'Options'.
3. Scroll  to 'Save number' and press 'Select'.

4. Enter a name and then press OK. The number is displayed. Press 'Save'.
5. Scroll  or  to the ringtone you want and press 'Select'.
6. Press  RED to return to standby.

Send a text message to a calls list number

1. Press 'Menu', scroll  to 'Calls Lists', then press 'Select', 'Missed Calls' is highlighted. If required, scroll  or  to 'Received' or 'Dialled Calls' then press 'Select'.
2. Scroll  or  to the entry you want and press 'Options'.
3. Scroll  to 'Send Message' and press 'Select'.
4. Write the message then press 'Options'.
5. 'Send' is highlighted. Then press 'Select'. (You can also save, insert a symbol, emoticon or template).
6. The number is pre-entered on the Send to screen, press 'Send' to send the message.











USING THE CALLS LIST



IMPORTANT

You must subscribe to your Network Provider's Caller Display service so that you can use text messaging and you must not withhold your telephone number.

To Delete a calls list entry

1. Press 'Menu', scroll  to 'Calls Lists' and then press 'Select'. 'Missed Calls' is highlighted. If required, scroll  or  to 'Received' or 'Dialled Calls' then press 'Select'.
2. Scroll  or  to the entry you want and press 'Options'.
3. Scroll  to 'Delete Call'. Press 'Select'.
4. Press  RED to return to standby.

To Delete the entire calls list

1. Press 'Menu', scroll  to 'Calls Lists' and then press 'Select'. 'Missed Calls' is highlighted. Scroll  to 'Delete Calls' and press 'Select'.
2. 'Missed Calls' is highlighted. Scroll  to 'All Calls' and press 'Select'.

3. Display shows 'Delete All Calls?' Press 'Yes' to confirm or 'No' to cancel.
4. Press  RED to return to standby.



USING THE AGENDA





You can use your handset to remind you of details of up to five events such as birthdays, anniversaries or appointments. Each entry can be up to 24 characters long.

Add a new event

1. Press 'Menu', scroll  to 'Agenda' and press 'Select'.
2. If no previous event is stored, 'Add Event', is highlighted, press 'Select'.



Or

If events are already stored, they are listed. Press 'Options', 'Add Event' is highlighted. Press 'Select'.

3. Enter the subject and press 'Save'.
4. Enter the date (DD/MM) and press 'Save'.
5. Enter the time, (HH:MM) and press 'Save'. If the current time format setting is 12 hour, 'Select' am or pm by pressing  or .
6. Press  or  to select 'Silent' or 'Alarm' and press 'Select'.
7. Press  RED to return to standby.

If you select alarm:

Scroll  or  to select 'Once' or 'Annually' and press 'Select'.

Scroll  or  to select when you want to receive the reminder 'At Event Time' or '30 Min Before', press 'Select'.

Press  RED to return to standby.

NOTE

If you 'Select' a silent reminder, the event subject is displayed on screen but no alarm will sound.

When the event memory is full, the display shows 'Memory Full'. You must delete an event before you can add a new one.





Switch off agenda ring

1. The event is displayed. Press 'View' to stop the alarm and see the details of the event. Or press 'Back' to stop the alarm and return to the standby screen. If no button is pressed, the alarm stops after one minute.









USING THE AGENDA

Show agenda details



1. Press 'Menu', scroll  to 'Agenda' and press 'Select'.
2. Stored events are displayed. If required scroll  to the event you want and press 'Options'.
3. Scroll  to 'Show Details' and press 'Select'. The description, date and time of the reminder are displayed.
4. Press  RED to return to standby.

Edit agenda

1. Press 'Menu', scroll  to 'Agenda' and press 'Select'.
2. Stored events are displayed. If required scroll  to the event you want and press 'Options'.
3. Scroll  to 'Edit Event' and press 'Select'.
4. Edit the subject and press 'Save'.
5. Edit the date and time and press 'Save'.
6. Press  or  to select 'Silent' or 'Alarm' and press 'Select'.
7. Press  RED to return to standby.



If you select alarm:

Scroll  or  to select 'Once' or 'Annually' and press 'Select'.

Scroll  or  to 'Select' when you want to receive the reminder 'At Event Time' or '30 Min before', press 'Select'.

Press  RED to return to standby.

Send agenda as a text message



1. Press 'Menu', scroll  to 'Agenda' and press 'Select'.
2. Stored events are displayed. If required scroll  to the event you want and press 'Options'.
3. Scroll  to 'Send as a Text' and press 'Select'.
4. The event is displayed. Press 'Options' to select send option and enter a destination number.
5. Press 'Send' to send your message.

Delete Agenda



1. Press 'Menu', scroll  to 'Agenda' and press 'Select'.



USING THE AGENDA

2. Stored events are displayed. Scroll  to the event you want to delete and press 'Options'.
3. Scroll  to 'Delete Event' and press 'Select'.
4. Press 'Yes' to confirm or 'No' to cancel.
5. Press  RED to return to standby.

Delete all Agendas

1. Press 'Menu', scroll  to 'Agenda' and press 'Select'.
2. Stored events are displayed. Press 'Options'.
3. Scroll  to 'Delete all events' and press 'Select'.
4. Press 'Yes' to confirm or 'No' to cancel.
5. Press  RED to return to standby.





CLOCK & ALARM







If you subscribe to your network's Caller Identification service, the time on your handset is set automatically each time you receive a call, depending on your network provider.

You can also set or adjust the time using the Clock & Alarm menu.

Set date and time manually





1. Press 'Menu' and scroll  to 'Clock & Alarm' and press 'Select'. 'Date & Time' is highlighted, press 'Select'.
2. Enter the date using the format DD/MM/YY and press 'Save'.
3. Press  RED to return to standby.

Set the alarm

1. Press 'Menu' and scroll  to 'Clock & Alarm' and press 'Select'.
2. Scroll  to 'Alarm' and press 'Select'.
3. Press  or  to select 'On' and press 'Select'.
4. Press  or  to select 'Once', 'Mon-Fri' or 'On Daily' and press 'Select'.





5. Enter the time for the alarm to sound and press 'Save'.
6. Press  RED to return to standby.

Alarm on/off

1. Press 'Menu' and scroll  to 'Clock & Alarm' and press 'Select'.
2. Scroll  to 'Alarm' and press 'Select'.
3. Press  or  to select 'On' or 'Off' and press 'Select'.
4. Press  RED to return to standby.

Time format

Set the time format to 12 or 24 hour setting.

1. Press 'Menu' and scroll  to 'Clock & Alarm' and press 'Select'.
2. Scroll  to 'Time Format' and press 'Select'.
3. Press  or  to select '12 Hour' or '24 Hour' and press 'Select'.
4. Press  RED to return to standby.







Switch off alarm ring

1. When the alarm sounds, press 'Stop'







HANDSET SETTINGS





Handset ringtone

1. Press 'Menu', scroll  to 'Settings' and press 'Select'.
2. 'Set Handset' is highlighted. Press 'Select'.
3. 'Ringtone' is highlighted. Press 'Select'.
4. Press  or  to highlight 'External Call' or 'Internal Calls'. Press 'Select' to confirm.
5. Scroll  or  to highlight the ringtone you want, there are 20 to choose from. Press 'Select' to confirm.
6. Press  RED to return to standby.

Handset ringer volume



1. Press 'Menu', scroll  to 'Settings' and press 'Select'.
2. 'Set Handset' is highlighted. Press 'Select'.
3. Scroll  to 'Ringer Volume' and press 'Select'.
4. Press  or  to display the volume level you want. Press 'Save' to confirm.
5. Press  RED to return to standby.

Receiver volume

1. Press 'Menu', scroll  to 'Settings' and press 'Select'.
2. 'Set Handset' is highlighted. Press 'Select'.
3. Scroll  to 'Receiver Volume' and press 'Select'.
4. Press  or  to display the volume level you want. Press 'Save' to confirm.
5. Press  RED to return to standby.

Handset name

Personalise your handset, with a name or location for example Peter or Bedroom. Maximum 10 characters.

1. Press 'Menu', scroll  to 'Settings' and press 'Select'.
2. 'Set Handset' is highlighted. Press 'Select'.
3. Scroll  to 'Handset Name' and press 'Select'.
4. Press 'Clear' to delete the current name and use the keypad to enter the new handset name. Press 'Save' to confirm.
5. Press  RED to return to standby.







HANDSET SETTINGS

Display language



Your handset has 5 different display languages, these are English, French, German, Italian and Spanish.



NOTE

As soon as you select a new display language, all the handset text displays will immediately change to this language.

1. Press 'Menu', scroll  to 'Settings' and press 'Select'.
2. 'Set Handset' is highlighted. Press 'Select'.
3. Scroll  to 'Language' and press 'Select'.
4. Scroll  or  to the language you want and press 'Select'.
5. Press  to return to standby.





Screensaver

1. Press 'Menu', scroll  to 'Settings' and press 'Select'.
2. 'Set Handset' is highlighted. Press 'Select'.
3. Scroll  to 'Screensaver' and press 'Select'.



4. Press  or  to highlight 'Clock' or 'Off' and press 'Select'.
5. Press  to return to standby.

Auto talk

With Auto talk switched on, you can answer a call just by lifting the handset off of the base.



1. Press 'Menu', scroll  to 'Settings' and press 'Select'.
2. 'Set Handset' is highlighted. Press 'Select'.
3. Scroll  to 'Auto Talk' and press 'Select'.
4. Scroll  or  to 'On' or 'Off'. Press 'Select' to confirm.
5. Press  to return to standby.

Key beep

1. Press 'Menu' scroll  to 'Settings' and press 'Select'.
2. 'Set Handset' is highlighted. Press 'Select'.
3. Scroll  to 'Key Beep' and press 'Select'.







HANDSET SETTINGS

4. Scroll  or  to 'On' or 'Off'. Press 'Select' to confirm.
5. Press  RED to return to standby.

PBX access code

If your Torque handset is connected to a switchboard, you may need to enter an access code for an outside line, eg 9, before you dial a number. You can save this access code in your Torque handset and it will be added automatically each time you dial.

1. Press 'Menu', scroll  to 'Settings' and press 'Select'.
2. 'Set Handset' is highlighted. Press 'Select'.
3. Scroll  to 'PBX Access Code' and press 'Select'.
4. Scroll  or  to 'On', 'Off' or 'Set Code'. Press 'Select' to confirm.





If you select 'Set code', enter the switchboard access code eg 9, then press 'Save'.

5. Press  RED to return to standby.









BASE SETTINGS

Base ringtone

1. Press 'Menu', scroll  to 'Settings' and press 'Select'.
2. Scroll  to 'Set Base'. Press 'Select'.
3. 'Ringtone' is highlighted. Press 'Select'.
4. Scroll  or  to highlight the ringtone you want, there are 5 to choose from. Press 'Select' to confirm.
5. Press  RED to return to standby.





Base ringer volume

1. Press 'Menu', scroll  to 'Settings' and press 'Select'.
2. Scroll  to 'Set Base'. Press 'Select'.
3. Scroll  to 'Ringer Volume'. Press 'Select'.
4. Scroll  or  to display the volume level you want. There are 5 volume levels plus 'Off'. Press 'Select' to confirm.
5. Press  RED to return to standby.

Dialling mode







Your Torque product is set to Tone dialling. You should not normally need to change this setting. The dial mode options are Tone or Pulse.

1. Press 'Menu', scroll  to 'Settings' and press 'Select'.

2. Scroll  to 'Set Base'. Press 'Select'.
3. Scroll  to 'Dialling Mode'. Press 'Select'.
4. Press  or  to highlight 'Pulse' or 'Tone'. Press 'Select' to confirm.
5. Press  RED to return to standby.

Recall mode

The default recall time is suitable for your country and network operator and is set at 100 ms (Recall 1).

1. Press 'Menu', scroll  to 'Settings' and press 'Select'.
2. Scroll  to 'Set Base'. Press 'Select'.
3. Scroll  to 'Recall Mode'. Press 'Select'.
4. Press  or  to highlight 'Recall 1' (100ms) or 'Recall 2' (250ms). Press 'Select' to confirm.
5. Press  RED to return to standby.





System PIN

The System PIN is used when changing certain settings and for handset/base registration/de-registration. The default setting is 0000 but you can change this to your own personal PIN number with up to 8 digits.



BASE SETTINGS

When you enter a PIN the digits are displayed as '****'.



1. Press 'Menu' scroll  to 'Settings' and press 'Select'.
2. Scroll  to 'Set Base'. Press 'Select'.
3. Scroll  to 'System PIN'. Press 'Select'.
4. Enter the old PIN (original setting 0000) and press OK.
5. Enter the new PIN and press OK. Re-enter the new PIN and press OK.
6. Press  RED to return to standby.

Master reset

You can restore your product to its default (original) settings. The Phonebook, Calls List and Answering Machine messages and personal Outgoing Messages will not be affected.

All handsets registered to the base will continue to be registered.







All text, answer machine, handset and base settings, such as ringer volumes etc., will be reset.

1. Press 'Menu', scroll  to 'Settings' and press 'Select'.
2. Scroll  to 'Set Base'. Press 'Select'.
3. Scroll  to 'Master Reset'. Press 'Select'.

4. 'Are You Sure?' is displayed. Select 'Yes' to confirm or 'No' to cancel.
5. If you select 'Yes', enter the system PIN (original setting 0000) then press OK. 'Please wait...' and then 'Reset Complete' will be displayed. The handset will return to standby.

ECO Mode

To reduce the level of power emissions, you can select 'ECO mode'. When the ECO mode is set to 'On', the base transmission power will be reduced.

1. Press 'Menu', scroll  to 'Settings' and press 'Select'.
2. Scroll  to 'Set Base'. Press 'Select'.
3. Scroll  to 'ECO Mode'. Press 'Select'.
4. Press  or  to highlight 'Off' or 'Eco Mode'. Press 'Select' to confirm.
5. Press  RED to return to standby.



REGISTRATION

Up to 5 handsets can be registered to the Torque base. Additional handsets must be fully charged and registered to the base before you can use them.

NOTE

If you have purchased a Torque multipack, any additional handsets in the box will already have been registered to the base and you will not need to register them.

- The instructions described below apply specifically to your Torque handset. If you wish to register another manufacturer's handset, the instructions may vary. In this case, please refer to the manufacturer of the additional handset.
- The Master PIN is required before you can register or de-register handsets. The default PIN is 0000.

To register a handset



At the base:



1. Press and hold the  button, which can be found underneath the Torque base, for at least 3 seconds until you hear a double beep. You have 60 seconds in which to register your additional handset.

At the handset:

2. If the handset is new and 'Please Register' is displayed. Press 'Menu'. 'Registration' is displayed press 'Select'

Or

If the handset has already been registered to another base the standby display is shown. Press 'Menu', scroll  or  to 'Registration' and press 'Select'.

3. 'Register Handset' is highlighted, press 'Select'.
4. Bases are displayed. If necessary scroll  or  to a new base you wish to register your handset to and press 'Select'.
5. Enter the System PIN (original PIN is 0000) and press OK.
6. 'Searching Base X' (where X is the chosen base number) then 'Handset Registered' is displayed.





The handset is automatically assigned the next available handset number eg: 2.





REGISTRATION



To select a base

You can register your Torque handset with up to 4 bases. Once registered, you can switch between bases, for example, bases at home and at work.

1. Press 'Menu', scroll  or  to 'Registration' and press 'Select'.
2. Scroll  to 'Select Base' and press 'Select'.
3. All base numbers are displayed. (In use) is added to bases where the handset has been previously registered. Scroll  or  to the base you want and press 'Select'.
4. 'Searching base...' is displayed, followed by the standby display for that base.

To De-register a handset

1. Press 'Menu', scroll  or  to 'Registration' and press 'Select'.
2. Scroll  to 'De-register' and press 'Select'.
3. Enter the system PIN (original PIN is 0000) and press OK.

4. Scroll  or  to the handset you want to de-register and press 'Select'.
5. Press 'Yes' to confirm or 'No' to cancel. The display confirms de-registration.
6. Press  RED to return to standby.

Internal Calls Call another handset

If you have more than one handset registered to the Torque base, you can make internal calls between two handsets.

1. Press 'int' (bottom right of the keypad), followed by the number of the handset (1-5) that you want to call.
2. Press OK to dial.

NOTE

When an internal call is received, the display shows Internal Call Handset X (where X is the number of the calling handset) .





REGISTRATION

Transfer a call

You can transfer an external call to another handset registered to the base.

During your call:

1. Press 'Int' (bottom right of the keypad), followed by the number of the handset (1-5) that you want to call.
2. Press OK to dial or press 'End' to cancel the call request and return to the caller.
3. When the other handset answers you can announce the caller.
4. Press  RED to complete the transfer.

3-Way conference call

You can hold a 3-way conference call between 2 internal and 1 external caller.

During your call to an external caller:

1. Press 'int' (bottom right of the keypad), followed by the number of the handset (1-5) that you want to call.
2. Press OK to dial.





3. When the other handset answers you can announce the caller.
4. Press 'Join' to begin the conference call. 'Conference Call' is displayed.
5. Press  RED to end the call.



ANSWERING MACHINE

Your Torque answering machine records unanswered calls when it is activated. It can store up to 59 messages within the maximum recording time of 11.5 minutes. Each message can be up to 3 minutes long. Your personal outgoing messages can be up to 3 minutes long.







To switch the answering machine on/off

1. Press 'Menu', scroll  to 'Answer Machine' and press 'Select'
2. Scroll  to 'Answer On/Off' and press 'Select'.
3. Scroll  or  to highlight 'On' or 'Off' and press 'Select'. When switched on the handset displays  in standby mode.

Answer Delay

Answer delay sets the number of times your product will ring before the answer machine picks up the call and starts playing the outgoing message. You can change this to between 2-9 rings or Time Saver. The default setting is 5 rings.







1. Press 'Menu', scroll  to 'Answer Machine' and press 'Select'

2. Scroll  to 'Answer Settings' and press 'Select'.
3. Scroll  or  to 'Answer Delay' and press 'Select'.
4. Scroll  or  to highlight the delay you want. Press 'Select' to confirm.
5. Press  RED to return to standby.

Time saver

When you ring in to access your messages remotely, if your answering machine is set to time saver and you have new messages it will answer after 2 rings. If you do not have any new messages it will answer after 5 rings. This means that you can hang up after 3 rings knowing you have no new messages and saving you the cost of the call. You cannot use this feature if you have BT Answer 1571 or Call Minder active on your line.

Switch message alert tone on/off

1. Press 'Menu', scroll  to 'Answer Machine' and press 'Select'.
2. Scroll  to 'Answer Settings' and press 'Select'
3. Scroll  or  to 'Message Alert' and press 'Select'.
4. Scroll  or  to highlight 'On' or 'Off' and press 'Select'.
5. Press  RED to return to standby.





ANSWERING MACHINE

On-screen alert

When you have new answering machine messages, the screen shows 'You have X new messages.'

If 'Mood lighting' is switched on, this will also flash on the base.

1. Press 'Play', then scroll  or  through the list of messages if there is more than one. All new messages are indicated by a dot.

Press 'Play' to hear the highlighted message.

Outgoing messages (OGM)

The outgoing message is the message a caller first hears when the answering machine picks up their call. There are 2 pre-recorded outgoing messages to choose from or you can record your own up to 3 minutes long. You can only record your outgoing message using the handset.





Answer & Record

The caller can leave a message. The pre-recorded message is 'Hello, your call cannot be taken at this moment, so please leave your message after the tone.'

Answer Only

The caller can listen to your announcement but cannot leave a message. The pre-recorded message is 'Hello, your call cannot be taken at this moment, and you cannot leave a message, so please call later.'

Record your own outgoing message

1. Press 'Menu' and scroll  to 'Answer Machine' and press 'Select'.
2. Scroll  to 'Outgoing Message' and press 'Select'.
3. 'Record' is highlighted. Press 'Select'.
4. Scroll  or  to 'Answer & Record' or 'Answer Only' and press 'Select'.
5. You will hear 'Please Speak after the Tone' and this is also displayed on the handset.









ANSWERING MACHINE

6. After the tone, speak your message clearly into the handset then press 'Save' to end the recording
7. Your outgoing message is played back. If you want to delete it, press 'Delete' during playback. If you press 'Save' or wait for the message to play back it will be saved.







Check or delete your outgoing message

Deleting a personal outgoing message automatically reinstates the pre-recorded outgoing message. You cannot delete a pre-recorded message.



1. Press 'Menu' and scroll  to 'Answer Machine' and press 'Select'.
2. Scroll  to 'Outgoing Message' and press 'Select'.
3. Scroll  to 'Play' and press 'Select'.
4. Scroll  or  to 'Answer & Record' or 'Answer Only' and press 'Select'.
5. Scroll  to 'Personal OGM' and press 'Select'.
6. The message is played. Press OK to stop playback or press 'Delete' to delete a personal OGM.

7. Press  RED to return to standby.

Select outgoing message mode

1. Press 'Menu' and scroll  to 'Answer Machine' and press 'Select'.
2. Scroll  to 'Answer Settings' and press 'Select'.
3. 'Answer Mode' is highlighted. Press 'Select'.
4. Scroll  or  to 'Answer & Record' or 'Answer Only' and press 'Select'.
5. If there is a personal OGM saved, press  or  to 'Default OGM' or 'Personal OGM' and press 'Select'. Your selection is confirmed. If there is no personal OGM saved the default OGM will be selected.
6. Press  RED to return to standby.

Record a memo

1. Press 'Menu' and scroll  to 'Answer Machine' and press 'Select'.
2. Scroll  to 'Record Memo' and press 'Select'.



ANSWERING MACHINE

3. You will hear 'Please Speak after the Tone' and this is also displayed on the handset.
4. After you hear the tone, speak your memo then press 'Save' to end the recording.
5. Your memo is played back. If you want to delete it, press 'Delete' during playback. If you press 'Save' or wait for the message to play back, it will be saved.
6. Press **O RED** to return to standby.



Call screening



When your answering machine is on and answers a call, you can use the loudspeaker to listen to the caller leaving a message. You can then identify the caller and decide whether to take the call in person.

1. When your product rings, wait for the answering machine to take the call. When the caller begins leaving a message, the handset will display 'Recording'. Press 'Screen' to hear the caller.
2. To interrupt and speak to the caller, press **O GREEN** or, after the caller has hung up and the display shows 'You have a new message', press 'Play' to play new messages.

3. Press **O RED** to return to standby.

Message playback

1. Press 'Menu' and scroll  to 'Answer Machine' and press 'Select'.
2. 'Play' is highlighted. Press 'Select' to choose which messages you want to play or scroll  to 'Play All' and press 'Select' to play all messages.
3. You can press **O GREEN** to switch between the earpiece and handset loudspeaker to listen to your messages.

During playback press 'Options', then scroll  or  to: 'Pause', 'Repeat Message', 'Skip Forward', 'Skip Backward', 'Delete'.

4. Press 'Select' to choose the highlighted option. At the end of playback, press **O RED** to return to standby.





ANSWERING MACHINE

Handset button shortcuts

During playback:

1	Pause
2	Resume
3	Repeat message
4	Play previous message
5	Delete current message
6	Play next message







Delete all old messages

1. Press 'Menu' and scroll  to 'Answer Machine' and press 'Select'.
2. Scroll  to 'Delete Messages' and press 'Select'.
3. 'Delete All Old Messages?' is displayed. Press 'Yes' to confirm or 'No' to cancel.
4. Press  RED to return to standby.

Remote access

You can operate your answering machine from any Touchtone™ phone by calling your Torque product and entering a 4 digit security code (original code is 0000).

Switch remote access PIN On or Off

1. Press 'Menu' and scroll  to 'Answer Machine' and press 'Select'.
2. Scroll  to 'Answer Settings' and press 'Select'.
3. Scroll  or  to 'Remote Access' and press 'Select'.
4. Scroll  or  to highlight 'On' or 'Off' and press 'Select'.
5. Press  RED to return to standby.







Change the remote access PIN

You should change your remote PIN from the original setting of 0000 to something more memorable and personal to you. Please keep a note of your new PIN and keep it somewhere safe.

1. Press 'Menu' and scroll  to 'Answer Machine' and press 'Select'.



ANSWERING MACHINE

2. Scroll  to 'Answer Settings' and press 'Select'.
3. Scroll  or  to 'Remote Access' and press 'Select'.
4. Scroll  or  to highlight 'Set Remote PIN' and press 'Select'.
5. Enter the old 4 digit PIN and press 'Save' (original PIN is 0000).
6. Enter the new 4 digit PIN and press 'Save'. Enter the new PIN again and press 'Save'.
7. Press  RED to return to standby.

Switch your answering machine on remotely

If you forget to switch your answering machine on, you can do it remotely from another phone.

1. Dial your phone number and let it ring. After 20 rings you will hear your outgoing message.
2. Press  on the telephone keypad and then enter your security code (original setting 0000).
3. Press 0 and your answering machine will switch on ready to answer incoming call.

Play messages remotely

1. Dial your phone number and let it ring. When you hear your outgoing message, press .
2. Enter your 4 digit PIN.
If you enter an incorrect PIN you will hear 'Incorrect security code'. You can try and enter the PIN 1 more time. If it is still incorrect you will hear the above voice prompt and the Torque product will end the call.
3. If no button is pressed for 8 seconds or more your Torque product will end the call.



ANSWERING MACHINE

4. Use your telephone keypad to operate your answering machine:

1	To hear the main menu
2	Play messages
3	Play new messages
4	Skip back during messages
5	Delete during messages
6	Skip forward during messages
7	Set to answer only (or answer & record) depending upon the Answer Mode status of the product at the time.
8	Record a new outgoing message
9	To set to answer off
0	To set to answer on

Memory full

The memory is full if there is less than 10 seconds of recording time left or if the maximum total of 59 messages has been reached.

When the memory becomes full:

- Your caller will be advised to complete their message within 10 seconds. If they are still talking when the memory becomes full they will hear 'Thank you for calling' and the answering machine will hang up.
- The machine will automatically switch to Answer Only mode and you will need to delete some messages before any more new messages can be recorded.



SIMPLE SOLUTIONS

The handset is not charging when the handset is placed on the charger base

- Poor charging contact, move the handset slightly on the base.
- Dirty contacts - Unplug from the mains power and clean the charging contacts with a cloth (Do not get wet, do not immerse in water)

No dialling tone

- No power - check the connections. Reset the base: unplug and plug back in the mains power.
- Batteries are empty - charge the batteries for at least 24 hours. Replace the rechargeable batteries.
- You are too far from the base - move closer to the base
- Wrong line cord - only use the telephone line cord provided

- Micro filter (required if you have Broadband) is not connected inbetween your telephone line cord and the telephone wall socket - connect the micro filter to your telephone line cord.

Poor audio quality

- The base is too close to electrical appliances, reinforced concrete walls or metal door frames - move the base at least one metre away from any electrical appliances.
- Micro filter (required if you have Broadband) is not connected inbetween your telephone line cord and the telephone wall socket - connect the micro filter to your telephone line cord.

The signal icon is blinking

- Handset is not registered to the base - register the handset to the base
- You are too far from the base - move closer to the base
- Check that the mains power is connected correctly.





SIMPLE SOLUTIONS

- The batteries may be low, place the handset in the charger to recharge.

No ring tone

- The ring tone is switched off.
- Increase the ringer volume.

Caller Line Identification (CLI) service does not work

- Check your subscription with your network operator

A phonebook entry cannot be stored

- The phonebook is full. Delete unused entries.

No display

- Try recharging or replacing the batteries.
- Try disconnecting and connecting the base power supply.

Unable to register another handset

- Maximum number of 5 handsets has been reached.

- The display shows Searching. You must de-register a handset in order to register a new one.

Noise interference on your radio or television

- Your base or charger may be too close. Move it as far away as possible.

You hear busy tone when you press

○ GREEN.

- Make sure that your handset is within range of the base.
- Another handset registered to the same base, may be on a call.

Answering machine does not record messages

- Switch the answering machine on.
- The memory may be full. If so, you will need to delete some messages.





SIMPLE SOLUTIONS

- Answer mode may be set to Answer Only. Change the mode to Answer & Record.

Cannot access messages remotely

- Remote access may be switched off.
- Check that you are using the correct PIN code.

Cannot record outgoing message

- The memory may be full. If so, you will need to delete some messages.

Answering machine stops automatically

- The memory may be full. If so, you will need to delete some messages.
- The maximum message length is 3 minutes.

If you are still experiencing any difficulty after making the above checks, please call the helpdesk for further assistance.

Helpdesk

The helpdesk is open from 8.30am to 5.00pm, Monday to Friday (excluding Bank Holidays) and can be contacted on 0845 833 1673 (local call charge applies) or by email: info@eurosuisse.co.uk.



SIMPLE SOLUTIONS

Possible problems with text messaging

Text messages cannot be sent and the screen displays 'Message Sending Failed'

- The base station power supply or telephone line cord might not be properly connected. Check that the base station power supply is plugged into the mains power socket and switched on and that the telephone is plugged into the telephone wall socket.
- There might be a fault on the line. Check that your telephone is working properly.
- You might have deleted the server number in error. See page 21 for instructions on how to enter this number.

Cannot send texts

- Check the service centre number is correct, including the 1470P prefix (this is for BT lines. If you have another network provider please check the prefix number with them). In order to send and receive text messages you must not withhold your number. If you normally withhold your number the 1470 prefix presents your number for you.

Cannot receive texts

- You will not be able to receive text messages until you have first sent a message. The first message sent registers you with the text service.
- More than 1 text message product is connected to the telephone line. Disconnect the other products.
- Check that the service centre number is correct
- Ensure that you have subscribed to a Caller Display service and that it is active. You can check this by noting if your phone displays your Caller's number when you receive an incoming call.



SIMPLE SOLUTIONS

Texts have previously been sent and received OK but we are now only receiving voice texts from 0845 6021111

- Send a text message RESET to 00000. You will receive a confirmation message back and you should be able to send and receive texts again.

This assumes that your Caller Display service is active and working on your line. Texts to 00000 are free.

You keep hearing an error beep

- You have pressed the wrong button in a sequence. Check the prompts in the display or refer to instructions in this user guide.



GENERAL INFORMATION

IMPORTANT

This equipment is not designed for making emergency telephone call when the power fails. Alternative arrangements should be made for access to the emergency services.

This product is intended for connection to analogue public switched telephone networks and private switchboards in the United Kingdom.

Safety information

- Only use the power supply provided. Using an unauthorised power supply will invalidate your guarantee and may damage the telephone.
- Use only the approved rechargeable batteries supplied.
- Do not open the base or handset (except to replace the handset batteries). This could expose you to high voltages or other risks.
- Radio signal transmitted between the handset and the base may cause interference to hearing aids.

- It is recommended that advice from a qualified expert be sought before using this product in the vicinity of emergency/intensive care medical equipment.
- It is recommended that if you have a pacemaker fitted you check with a medical expert before using this product.
- Your product may interfere with other electrical equipment, e.g. TV and radio sets, clock/alarms and computers if placed too close.
- It is recommended that you place your product at least one metre away from such appliances to minimise any risk of interference.
- Never dispose of batteries in a fire. There is a serious risk of explosion and/or the release of highly toxic chemicals.

Cleaning

- Clean the handset and base with a damp (not wet) cloth, or an anti-static wipe.





GENERAL INFORMATION

- Never use household polish as this will damage the product. Never use a dry cloth as this may cause a static shock.

Environmental

- Do not expose to direct sunlight.
- The handset may become warm when the batteries are being charged or during prolonged periods of use. This is normal. However, we recommend that to avoid damage you do not place the product on antique/veneered wood.
- Do not stand your product on carpets or other surfaces which generate fibres, or place it in locations preventing the free flow of air over its surfaces. Do not submerge any part of your product in water and do not use it in damp or humid conditions, such as bathrooms.
- Do not expose your product to fire, explosive or other hazardous conditions.

- There is a slight chance your base and handset could be damaged by an electrical storm. We recommend that you unplug the power and telephone line cord during an electrical storm.

Product disposal instructions



- The symbol shown here and on the product means that the product is classed as Electrical or Electronic Equipment and should not be disposed with other household or commercial waste at the end of its working life.
- The Waste of Electrical and Electronic Equipment (WEEE) Directive (2002/96/EC) has been put in place to recycle products using best available recovery and recycling techniques to minimize the impact on the environment, treat any hazardous substances and avoid increasing landfill.



GENERAL INFORMATION

Product disposal instructions for residential users

- When you have no further use for it, please remove any batteries and dispose of them and the product per your local authority's recycling processes. For more information please contact your local authority or the retailer where the product was purchased.

Warranty Information

- This product has a warranty of 12 months and is therefore guaranteed to be free from defects in materials and workmanship during that period. If you experience a problem within that time, simply call the helpdesk on 0845 833 1673 (local call rate applies).

If your problem cannot be solved by our helpdesk, you will need to return your product to the place it was purchased. Remember to take your receipt as proof of purchase as it must be produced before the warranty can be honoured.

- This product must have been used only for the intended purpose and not been subjected to wilful or accidental damage.
- This warranty does not cover damage caused by excessive voltage or lightning.
- If this product has been tampered with in any way, the warranty shall be considered null and void.
- This guarantee does not affect your statutory rights.





GENERAL INFORMATION

How many telephones can I have?

All items of telephone equipment have a Ringer Equivalence Number (REN), which is used to calculate the number of items which may be connected to any one telephone line. Your Torque product has a REN of 1. A total REN of 4 is allowed. If the total REN of 4 is exceeded, the telephones may not ring. With different telephone types there is no guarantee of ringing, even when the REN is less than 4.

Any additional handsets and chargers that you register have a REN of 0.

R&TTE

This product is intended for use within the UK for connection to the public telephone network and compatible switchboards.

This equipment complies with the essential requirements for the Radio Equipment and Telecommunications Terminal Equipment Directive 1999/5/EC.

Connecting to a switchboard

This product is intended for use within the UK for connection to the public telephone network and compatible switchboards, which support tone dialling and timed break recall. If in doubt please consult your service provider.

Inserting a pause

With some switchboards, after dialling the access code you may have to wait for a moment while the switchboard picks up an outside line so you will need to enter a pause in the dialing sequence.

- Press and hold  until the display shows P to insert a pause before entering the telephone number.

You may also need to enter a pause when storing international numbers or charge card numbers

Recall

You may need to use the recall function if you are connected to a switchboard/PBX (Private Branch Exchange), contact your PBX supplier for further information.





TECHNICAL INFORMATION

Technical Specification

Standard:	Digital Enhanced Cordless Telecommunications (DECT)
Operating Frequency:	1880-1900 MHz
Range:	300 m outdoors and 50 metres indoors, in ideal conditions
Operating duration:	100 hours standby time 10 hours of talk time
Operating temperature:	0°C to 45°C (32°F to 113°F)
Storage temperature:	-20°C to 60°C (-4°F to 140°F)
Rechargeable batteries (each handset):	2 x NiMH 1.2V (AAA)
Base unit voltage:	100-240V / 50/60Hz

Declaration of Conformance

Hereby, Magic Box ES Ltd., declares that this Torque product is in compliance with the essential requirements and other relevant provisions of Directive 1999/5/EC.

The declaration of conformance for the Magic Box Torque product is published on the website: www.magicboxproducts.com.





MAGICBOX™

Helpline
0845 833 1673
(local call rate)



Feb10/Issue 1

Magibox is a trademark of Euro Suisse International Ltd.