

# Meridian Digital Telephones

M3901  
M3902  
M3903  
M3904

User Guide





|   |           |
|---|-----------|
| <b>M3900 Series Meridian Digital Telephone</b>        | <b>1</b>  |
| M3901 .....   | 1         |
| M3902 .....   | 2         |
| M3903 .....   | 3         |
| M3904 .....   | 4         |
| <b>Your Telephone's Controls</b>                      | <b>5</b>  |
| <b>Terms you should know</b>                          | <b>8</b>  |
| <b>Your telephone call features</b>                   | <b>10</b> |
| Use handsfree calling (M3902, M3903, and M3904) ..... | 10        |
| Activate/deactivate Group listening controls .....    | 12        |
| Use the Redial list on the M3903 .....                | 14        |
| Use the Redial List on the M3904 .....                | 14        |
| Use the Predial feature .....                         | 15        |
| <b>Make a call</b>                                    | <b>17</b> |
| Make a call while on-hook .....                       | 18        |
| Make a call with the dial pad .....                   | 18        |
| Auto Dial .....                                       | 18        |
| Ring Again .....                                      | 19        |
| Redial last number called .....                       | 20        |
| Use Speed Call .....                                  | 21        |
| Make a System Speed Call .....                        | 22        |
| Use Hot Line .....                                    | 22        |
| Make an Intercom call .....                           | 23        |
| <b>Answer a call</b>                                  | <b>24</b> |
| <b>While on an active call</b>                        | <b>25</b> |
| Place a call on Hold .....                            | 25        |
| Transfer a call .....                                 | 25        |
| Use Timed Reminder Recall .....                       | 26        |
| Use Attendant Recall .....                            | 27        |
| Use Call Park .....                                   | 28        |

|                                     |    |
|-------------------------------------|----|
| Record a Calling Party Number ..... | 30 |
| Display incoming calls .....        | 30 |
| Trace a Malicious call .....        | 31 |

## **Incoming calls** **32**

---

|                                     |    |
|-------------------------------------|----|
| Activate Automatic Answerback ..... | 32 |
| Activate Call Pickup .....          | 33 |
| Use Call Waiting .....              | 34 |

## **While you are away from your desk** **35**

---

|                                   |    |
|-----------------------------------|----|
| Forward calls .....               | 35 |
| Forward internal calls only ..... | 35 |
| Use Remote Call Forward .....     | 36 |
| Secure your telephone .....       | 38 |

## **Talk with more than one person** **40**

---

|  |    |
|--|----|
| Set up a Conference call .....                   | 40 |
| Join a call .....                                | 40 |
| Selectable Conferee Display and Disconnect ..... | 41 |
| Use Group Call .....                             | 42 |

## **Work without interruption** **44**

---

|                              |    |
|------------------------------|----|
| Activate Make Set Busy ..... | 44 |
|------------------------------|----|

## **Additional Call Features** **45**

---

|   |    |
|---|----|
| Auto Dial Transfer Feature .....            | 45 |
| Use the buzz signal .....                   | 45 |
| Call Page to make an announcement .....     | 46 |
| Centrex/Exchange Switchhook Flash .....     | 46 |
| Charge a call or Forced Charge a call ..... | 47 |
| Enhanced Override Feature .....             | 49 |
| Forced Camp-on .....                        | 49 |
| Override Feature .....                      | 50 |
| Privacy Release Feature .....               | 51 |
| Radio Page Feature .....                    | 51 |
| Voice Call Feature .....                    | 53 |

|  |           |
|--|-----------|
| <b>Hospitality features</b>  | <b>54</b> |
| Automatic Wake-Up .....  | 54        |
| Message Registration .....   | 56        |
| Maid Identification .....  | 57        |
| Room Status .....  | 58        |
| <b>Telephone display</b>   | <b>59</b> |
| M3902 display .....  | 59        |
| M3903 display .....  | 59        |
| M3904 display .....  | 60        |
| <b>Options List</b>  | <b>61</b> |
| Select a language .....  | 62        |
| Change a Feature Key label .....                                       | 62        |
| Adjust Screen contrast .....   | 64        |
| Adjust volume .....  | 64        |
| Choose Ring type .....   | 65        |
| Select Call Log options .....  | 65        |
| Use Live dial pad .....  | 66        |
| Select Preferred name match .....                                      | 66        |
| Set up area code .....   | 67        |
| Enable Call timer .....  | 67        |
| Select Date/time format .....  | 67        |
| Enable Key click .....   | 68        |
| Use Headset port on call .....   | 68        |
| Activate Headset port external alerter .....                           | 69        |
| Use Call indicator light .....   | 69        |
| Set On-hook default path .....   | 70        |
| Display diagnostics .....  | 70        |
| Control Group Listening .....  | 71        |
| <b>Directory display and navigation</b>                                | <b>72</b> |
| M3903 Directory display and navigation .....                           | 72        |
| Access your Callers List or Redial List (M3903) .....                  | 72        |
| M3904 Directory display and navigation .....                           | 73        |
| Access your Call Log, Redial List, or Personal Directory (M3904) ..... | 73        |

|   |    |
|---|----|
| Directory password protection (M3904) ..... | 74 |
|---|----|

## **Call Log** **77**

---

|   |    |
|---|----|
| Access and use the Callers List (M3903) ..... | 77 |
| Access and use the Callers List (M3904) ..... | 78 |

## **Redial List** **80**

---

|                                   |    |
|-----------------------------------|----|
| Use the Redial List (M3903) ..... | 80 |
| Use the Redial List (M3904) ..... | 80 |

## **Use the Personal Directory** **82**

---

|   |    |
|---|----|
| Access the Personal Directory .....             | 82 |
| Add a Personal Directory entry .....            | 82 |
| Add an incoming call .....                      | 84 |
| Add an outgoing call .....                      | 85 |
| Delete or edit a Personal Directory entry ..... | 86 |
| Delete your Personal Directory .....            | 87 |
| Use the Personal Directory to make a call ..... | 87 |
| Use Card View .....                             | 88 |
| Search for an entry .....                       | 88 |
| Copy a number from the Redial List .....        | 89 |

## **M3901 Feature Operation** **90**

---

|   |    |
|---|----|
| M3901 Fixed Keys .....                          | 90 |
| Use a programmed feature or an Auto Dial .....  | 92 |
| Use Auto Dial .....                             | 93 |
| Use Speed Call .....                            | 93 |
| Use Call Transfer .....                         | 94 |
| Use Conference Call feature .....               | 95 |
| Activate Ring Again .....                       | 96 |
| Make a call .....                               | 97 |
| Receive a call .....                            | 97 |
| Feature Activation Indicator .....              | 97 |
| Message Waiting and Call Status Indicator ..... | 97 |

## **Accessories for the M3900 Series telephones** **98**

---

|   |    |
|---|----|
| Accessory Connection Module (ACM) ..... | 98 |
|---|----|

|  |            |
|--|------------|
| Analog Terminal Adapter (ATA) .....                      | 98         |
| External Alerter and Recorder Interface .....            | 98         |
| Headsets .....   | 98         |
| Key-based Expansion Module (KEM) .....                   | 98         |
| <b>Meridian 1 Flexible Feature Codes (FFCs)</b> .....    | <b>99</b>  |
| <hr/>  |            |
| <b>Meridian SL-100 Feature Access Codes (FACs)</b> ..... | <b>100</b> |
| <hr/>  |            |
| <b>Index</b> .....                                       | <b>101</b> |
| <hr/>  |            |





## M3900 Series Meridian Digital Telephone

There are five models in the M3900 Series Meridian Digital Telephone Portfolio. This document describes the **M3901**, **M3902**, **M3903**, and **M3904** features and how to use them. The **M3902**, **M3903**, and **M3904** are described in the main portion of this document. The **M3901** is described in a separate section of this document. For information on the **M3905** refer to the *M3905 Call Center Meridian Digital Telephone User Guide*.

### M3901

The **M3901** has one Line (DN) Key and can be programmed with up to five features.

#### M3901

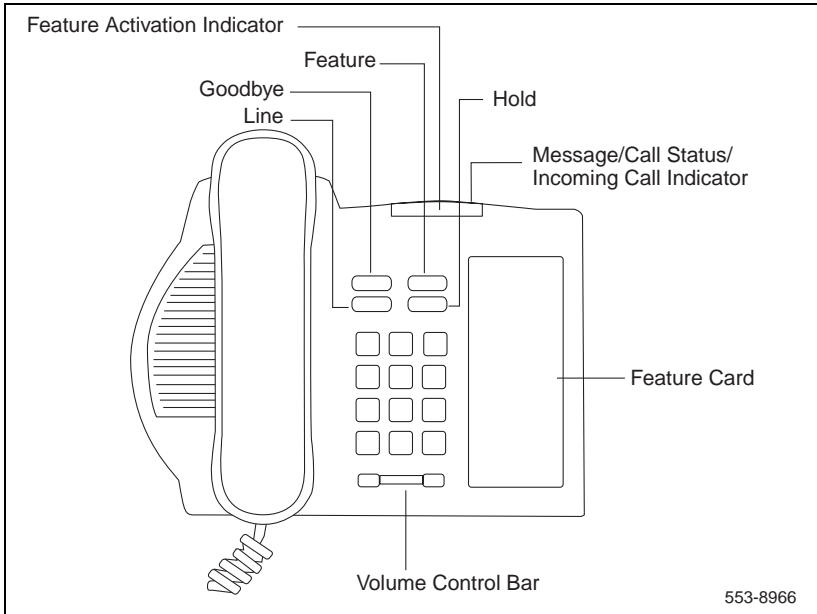

**Note:** The Meridian SL-100 configures the Line (DN) Key as a Directory Number only.

## M3902

The **M3902** has one Line (DN) Key, and three Programmable Soft Keys (self-labeled).

### M3902

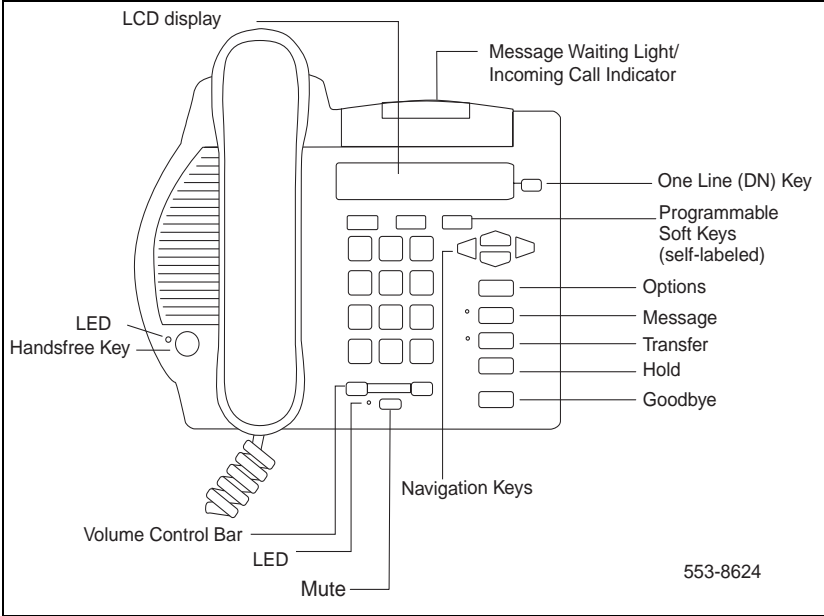

## M3903

The **M3903** has two Programmable Line (DN)/Feature Keys (self-labeled) with two features or lines configured on each key. It also has four Programmable Soft Keys (self-labeled).

### M3903

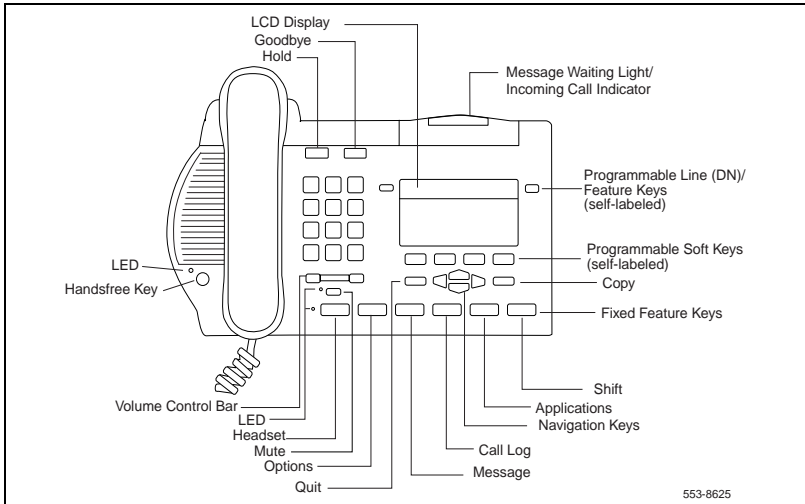

## M3904

The **M3904**, has six Programmable Line (DN)/Feature Keys (self-labeled), with two features or lines configured on each key. It also has four Programmable Soft Keys (self-labeled).

### M3904

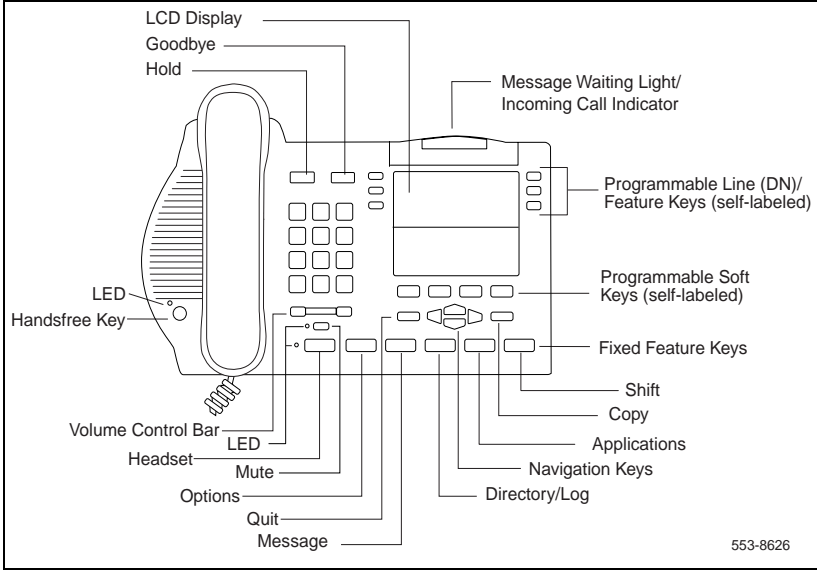

## Your Telephone's Controls



Use the **Volume Control Bar** to control the volume of the handset, headset, speaker, ringer, and handsfree. Increase the volume by pressing the right side of the bar. Lower it by pressing the left side.



You can terminate an active call by pressing the **Goodbye Key**. The **Goodbye Key** is useful for disconnecting a handsfree call.



Press the **Headset Key** to answer a call while on the headset or to switch a call from handset or handsfree to the headset.



A steady LCD indicator appearing beside a **Line (DN) Key** means that the feature or line is active. A flashing LCD indicator means the line is on hold or the feature is being programmed.



By pressing the **Hold Key**, you can put an active call on hold. Return to the caller by pressing the DN Key beside the flashing indicator.



The **Handsfree Key** allows you to activate the handsfree (**M3902**, **M3903**, and **M3904**) and Group listening features (**M3903** and **M3904**). The speaker LED lights to indicate handsfree is active, the LED flashes to indicate Group listening is active.



The **Mute Key** allows you to listen to a conversation without being heard. This is especially useful when you only want to listen on a conference call. Push the Mute Key again to return to a two way conversation. The **Mute Key** applies to handsfree, handset, and headset microphones. The Mute LED flashes when



the Mute option is in use.

The **Navigation** Keys allow you to scroll through Menus and lists on the display.

The **Copy** Key copies incoming or outgoing call numbers into the Personal Directory.

The **Quit** Key ends an active application. Pressing the **Quit** Key does not affect the status of the calls currently on your telephone.

**Note:** If you press the Quit Key before the Done Key you exit the Options List without saving changes. Press the Done Key to exit and save the changes.



2496



2498



The **Options** Key allows you to access and modify telephone options.

**Line/Directory Number (DN)** Key(s) are assigned to your telephone. They can be a Primary DN (PDN), secondary DN(s), multiple appearance DN(s), etc.

The lower right hand Line/Feature Key is your **Primary Directory Number (PDN) Key (M3902, M3903, M3904)**. When you pick up the handset, the line associated with this key is ready for you to make a call.

**Note:** You have only one Primary Directory Number assigned to your telephone. You can have additional Line/Directory Number (DN) Key(s) assigned to your **M3903** or **M3904** telephone.

Dial



The **Dial** Key is used to dial numbers stored in the Directory and Callers List (**M3903** and **M3904**). The **Dial** Key accesses the Primary Directory Number (PDN) Key to make a call.

Edit



Delete



More...



Example:

Trans



CallWait



The **Edit** Key is used to edit Directory and Callers List entries (**M3904**).

The **Delete** Key is used to delete entries or characters in applications.

The **Directory/Log** Key (**M3904**) allows you to access your Personal Directory, the Call Log (last 100 incoming calls), and the Redial list (last 20 outgoing calls).

The **Call Log** Key (**M3903**) allows you to access the Call Log (last 10 incoming calls), and the Redial list (last 5 outgoing calls).

The **Shift** Key allows you to access the second layer of the Programmable Line/Feature Keys (**M3903** and **M3904**).

The **More** Key allows you to access the additional layers of the Programmable Soft Keys.

**Programmable Soft** Keys (self-labeled) are configured for various features on the **M3902**, **M3903**, or **M3904** Telephones. The **Programmable Soft** Keys are located below the display area. These keys have an LCD label above them that changes based on available features or the active application.

**Programmable Line (DN)/Feature** Keys (**M3903** or **M3904**) are located at the sides of the upper display area. Once configured, these **Programmable Line (DN)/Feature** Keys provide one-touch feature activation. A status icon indicates call or feature status.

## Terms you should know

**Attendant** — The attendant is a telephone operator in your organization.

**Call Log** — The Call Log can be configured to store either unanswered or all incoming calls. These entries can be accessed through your directory menu.

**Call party information** — When your telephone rings, the display shows Calling Line Identification (CLID) information. The system must have CLID enabled. The display module shows the phone number and name of the incoming call.

**Card View** — The Card View displays a directory entry name and telephone number.

**Copy Key** — The Copy Key allows the **M3904** to copy information from one application to the Personal Directory.

**Date/time display feature** — The Date/time display feature shows the month and date while the telephone is in an idle state.

**Directory Number (DN)** — The Directory Number (DN) is a telephone number that consists of one to seven digits. The DN is commonly known as an extension number.

**Feature Access Codes (FACs)** — Feature Access Codes (FACs) allow you to access features for which you do not have a fixed or soft feature key. Feature Access Codes are applicable to the Meridian SL-100 system only. For your convenience, the FACs for your system can be printed on a page located at the back of this guide.

**Flexible Feature Codes (FFCs)** — Flexible Feature Codes (FFCs) allow you to access features for which you do not have a fixed or soft feature key. Flexible Feature Codes are applicable to the Meridian 1 system only. For your convenience, the FFCs for your system can be printed on a page located at the back of this guide.

**Fixed Keys** — The Fixed Keys are the hard labeled keys on your telephone.

**Indicator** — An indicator is an LCD or LED that displays the current status of a feature by its state; flashing, winking, steady on, or off.

**Information screen** — The Information screen displays call activity, lists, prompts, and status of calls.

**Interrupted dial tone** — Interrupted dial tone is a broken or pulsed dial tone, heard when you access some of the features on your telephone.

**Meridian 1** — The Meridian 1 is your office communications system.



**More...** — The More Key allows access to the multiple layers of Programmable Soft Keys. These keys are the keys located below the display on your telephone.

**Off-hook** — Off-hook is a term used to indicate that the telephone is active and ready to make a call. Your telephone's status changes to off-hook when you pick up the handset or press a Line (DN) Key.

**Paging tone**—Paging tone is a special tone heard when using the Radio Paging feature. You hear two beeps followed by dial tone.

**Personal Directory** —The Personal Directory stores entries by name and phone number.

**Primary Directory Number**— The Primary Directory Number is the main extension number on your telephone. It is accessed through the Primary Directory Number (PDN) Key.

**Private Line** — Private Line can be assigned to your telephone. With this line, you can reach an outside number without dialing a code to access an outside line. Internal extensions cannot be dialed from a private line.

**Redial List**— The Redial List is accessed through the Call Log Key on the **M3903** and through the Directory/Log Key on the **M3904**. It lists outgoing numbers for calls that have been made from your telephone.

**Ringback/ring tone**— Ringback/ring tone is the sound you hear when a call you have made is ringing at its destination.

**Shared Directory Number** — A shared Directory Number is a DN (extension) that is shared by two or more telephones. This is also known as a Multiple Appearance DN (MADN).

**Special dial tone**— The special dial tone refers to three consecutive short tones followed by steady dial tone that you hear when accessing some of your telephone features.

**Switchhook** — The switchhook is the button which the handset presses down, disconnecting your call, when you replace the handset. When lifted, the handset releases the switchhook and you either answer an incoming call or you receive dial tone indicating that your telephone is ready to make a call.

## Your telephone call features

Your network administrator assigns features to your programmable feature keys. Whenever this guide describes a procedure that requires special codes ask your network administrator to provide these to you.

To access a feature, you press a Feature Key, or enter a Flexible Feature Code (FFC) for the Meridian 1 or a Feature Access Code (FAC) for the Meridian SL-100. Your network administrator supplies you with the Flexible Feature Codes or Feature Access Codes for your system.

**Note:** In order to use a feature described in this section, your system software must support the feature and the feature must be assigned to your telephone. Check with your network administrator for more details.

### Use handsfree calling (M3902, M3903, and M3904)

---

If your telephone is an **M3902**, **M3903**, or **M3904** you can use the built-in microphone and speaker instead of the handset to make or receive a handsfree call. While on an active call, you can switch between Handset and Handsfree mode.

To answer a call with handsfree:



Press the **Handsfree** Key. You are now on a handsfree call.

To discontinue a handsfree call:



Press the **Goodbye** Key to end the call.

To mute a handsfree call:



1. Press the **Mute** Key. The LED indicator flashes.



2. Press the **Mute** Key again to return to a two way handsfree conversation.

To switch from handsfree to handset:



1. Lift the **handset** to switch from handsfree to handset.



2. Replace the **handset** to end the call.

## To switch from handset to handsfree:

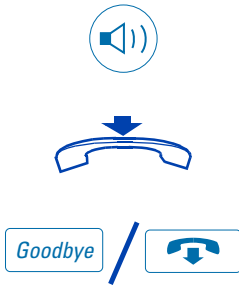

1. Press the **Handsfree** Key.
2. Replace the **handset**.
3. Press the **Goodbye** Key to end the call.

## To use headset:



Connect headset to the headset jack or the handset jack depending on the headset type and the telephone you are using.

Press the **Headset** Key (**M3903** and **M3904**). For the **M3902** read the instructions that came with your recommended headset.

**Note 1:** There are amplified and unamplified headsets that are compatible with your M3900 Series Telephone. Refer to Hardware Options for recommended headset types for you telephone.

**Note 2:** Access Volume Adjustment in the Options List to adjust the headset volume and gain that work best with the headset type you are using.

## To switch from handsfree to headset:



Connect headset or put headset on.

Press the Headset Key (**M3903** and **M3904**). For the **M3902** read the instructions for the headset you are using.

**Note:** A Headset Key is used to switch between the headset and the handset mode of operation (**M3903** and **M3904**). The LED lights steadily to indicate you are in headset mode. The headset LED is dark (unlit) if you are in handset mode.

## Activate/deactivate Group listening controls

The **Group listening** feature allows others to listen to a call through the speaker while you are speaking through the handset. This feature must be enabled by your network administrator.

To activate Group listening controls:



Group listening

Select



On



1. While on a call that you want to share with others who are present, press the **Options** Key.
2. Use the up and down **Navigation** Keys to scroll through the Options List and highlight **Group listening**.
3. Press the **Select** Key.
4. Press the **On** Key.
5. Press the **Handsfree** Key. Everyone will hear the caller over the speaker, but the caller will only hear what is picked up by the handset.

**Note:** You must tell the caller that others are listening to the conversation because Group listening does not alert the caller that the conversation is being monitored.

To deactivate Group listening controls:



Group listening

1. Press the **Options** Key.
2. Use the up and down **Navigation** Keys to scroll through the menu and highlight **Group listening**.

Select



Off



Done



Quit



3. Press the **Select** Key.
4. Press the **Off** Key to turn Group listening off.
5. Press the **Done** Key to save changes.
6. Press the **Quit** Key to exit.

**To mute a group listening call:**



1. Press the **Mute** Key. The LED flashes.
2. Press the **Mute** Key again to return to two way conversation.

**To switch from Group listening to handsfree:**



Hold down the **Speaker** Key while replacing the handset.

**Note 1:** The Group listening feature must be configured for your telephone by your network administrator. Activate the feature through the Options List to use Group listening.

**Note 2:** You must let the other party know when others are listening to the conversation. This feature does not have a tone to inform the party on the other end of the call that the conversation is being monitored.

### Use the Redial list on the M3903

---

The **Redial List** records the outgoing call numbers.

To access the Redial list on the M3903:



Redial List

Select



To use the Redial list:



Dial



1. Press the **Call Log** Key.
2. Use the up and down **Navigation** Keys to highlight Redial List.
3. Press the **Select** Key.

1. Use the up and down **Navigation** Keys to scroll through the Redial List and highlight the number you want to call.

**Note:** If you are calling an external or long distance number, be sure that the appropriate access codes are included.

2. Press the **Dial** Key. Your call is automatically dialed and you exit the Redial List.

### Use the Redial List on the M3904

---

To access the Redial List on the M3904:



1. Press the **Directory/Log** Key.



Call Log (Redial List)

Select



To use the Redial List:



Dial



2. Use the up and down **Navigation** Keys to highlight Call Log (Redial List).

3. Press the **Select** Key.

1. Use the up and down **Navigation** Keys to scroll through the Redial List and highlight the number you want to call.

**Note:** If you are calling an external or long distance number, be sure that the appropriate access codes are included.

2. Press the **Dial** Key. Your call is automatically dialed and you exit the Redial List.

## Use the Predial feature

The **Predial** feature allows you to enter and preview a number and make corrections before you dial the number.

To use Predial:



2498



1. Replace the **handset**, if it is off the cradle.
2. **Dial** the number.
3. Press a **Line** (DN) Key to receive dial tone, the displayed predialed number is automatically dialed.
4. Lift the **handset** when the called party answers or, if on handsfree, begin to talk.

To edit a predial number:



2498



1. Without selecting a Line Key, **dial** the number.
2. Use the left and right **Navigation** Keys to move the cursor and edit the number if necessary.

**Note:** If you are calling an external or long distance number, be sure that the appropriate access codes are included.

3. When you have made the necessary changes to the number, press a **Line** (DN) Key to call the number.

**Note:** You cannot use the Predial feature if the Live dial pad feature is active.



## Make a call

This section describes features that you can use when you make a call. There are several ways to make a call from your M3900 Series Meridian Digital Telephone. To make a call from your telephone, use the features described in this chapter.

To make a call:



or

2498



or



or



1. Lift the **handset**.

or

Press the **Line** (DN) Key.

or

Press the **Handsfree** Key.

**Note:** The Handsfree Key must be enabled by your network administrator

or

Press the **Headset** Key if you have a headset connected to your telephone (available on the **M3903** and **M3904**).

2. **Dial** the number.

**Note:** Whenever you read “Lift the handset,” in this guide, you may alternatively press a free Line (DN) Key, Handsfree Button, or the Headset Key. You receive dial tone with each of these actions.

To change from headset to handset:



The **Headset** Key is used to switch to the headset mode of operation. The LED lights steadily to indicate when you are in headset mode.

### Make a call while on-hook

---

To make a call while on-hook, leave the handset in the cradle while you dial a number.

To dial on-hook:

2498



1. Press a **Line** (DN) Key.
2. **Dial** the number when you receive dial tone.
3. Lift the **handset** when the called party answers. If you are on handsfree, begin to talk.

### Make a call with the dial pad

---



1. Lift the **handset**.
2. **Dial** the number.

### Auto Dial

---

**Auto Dial** lets you dedicate a feature key to a specific telephone number. When the Auto Dial Key is pressed, the number is dialed automatically. This feature must be enabled by your network administrator.

To use Auto Dial:



AutoDial



1. Lift the **handset**.
2. Press the associated **Auto Dial** Key. This automatically dials the number.

To display the Auto Dial number (M3903 and M3904):

Display



1. Press the **Display** Key.

**Note:** On the Meridian SL-100, press the **Auto Dial** Key to display the number.

AutoDial 

To store an Auto Dial number:

AutoDial 



AutoDial 

2. Press the configured **Auto Dial** Key. The number appears on the display.

1. Press the **Auto Dial** Key, without lifting the handset.

2. **Dial** the number to be stored on the Auto Dial Key.

3. Press the **Auto Dial** Key again. The number is stored on the key.

**Note:** To change the key label "AutoDial", select **Change feature key label** from the **Options List** menu. Please see "Change a Feature Key label" on page 62 for detailed instructions.

## Ring Again

Use the **Ring Again** feature when you receive a busy tone or no answer, while you are trying to reach someone in your private network. When you activate Ring Again you receive an audible tone notification when that person is available or has used their telephone. The Ring Again feature allows you to automatically redial the number.

To use Ring Again:



RingAgain



1. **Dial** a number and receive a busy tone or no answer.

**Note:** On the Meridian SL-100, Ring Again is available on busy tone only.

2. Press the **Ring Again** Key.

3. Press the **Goodbye** Key.

## Make a call

To call a Ring Again party when you receive notification:



RingAgain



To cancel Ring Again before notification:

RingAgain



When the number you want to reach is available, or the person has re-used their set, you hear the Ring Again tone.

1. Lift the **handset**, you receive dial tone.
2. Press the **Ring Again Key**.

Press the **Ring Again Key** a second time before hearing the notification tone.

## Redial last number called

---

**Last Number Redial** allows you to automatically redial the last number you dialed.

To use Last Number Redial:



2498



or

2498



2498



1. Lift the **handset**.
  2. Press a **Line (DN) Key**.
- or

Press the **Line (DN) Key** twice. The last number you dialed is automatically redialed.

**Note:** On Meridian SL-100, press the  twice.

**Note:** Your network administrator must configure this feature for your telephone.

## Use Speed Call

**Speed Call** allows you to automatically dial frequently called telephone numbers by entering a one, two, or three digit code. See your network administrator to determine the capacity of your Speed Call list. A telephone designated as a Speed Call Controller can program or edit the Speed Call list. This feature must be enabled by your network administrator.

**To store or change a Speed Call number:**



1. Press the **Speed Call Controller** Key. The triangular icon flashes, indicating programming mode.
2. The phone prompts you to **dial** a one, two, or three digit code and telephone number.

**Note:** Dial the access code (if required) followed by the internal, external, or long-distance telephone number.

3. Press the **Speed Call Controller** Key again to save the code and number. The flashing icon turns off.

**To make a Speed Call:**



1. Lift the **handset**.
2. Press the **Speed Call Controller** key or the **Speed Call User** Key.
3. **Dial** the Speed Call code.

## Make a System Speed Call

---

**System Speed Call** allows you to make a call by dialing Speed Call codes which may override your telephone's class of service restrictions. The System Speed Call feature is set up on the system by your network administrator. It is a speed dial number that is common to many users, therefore it is set up on the system not on your individual telephone.

**To make a System Speed Call:**



SScCtrlr or SScUser

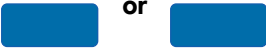

1. Lift the **handset**.
2. Press the **System Speed Call Controller** key or the **System Speed Call User** Key.
3. **Dial** the Speed Call code of the number you want to dial.  
The number is automatically dialed.

## Use Hot Line

---

The network administrator can program a **Hot Line** Key that allows you to dial a specific number automatically. The network administrator can apply other features to the Hot Line such as Call Redirection, so that the Hot Line call is answered by a person and not by a voice mail box.

**To use Hot Line:**

Hotline



Press the **Hot Line** Key. The Hot Line Key automatically dials the number.

**Note 1:** On the Meridian SL-100 system, the Automatic Line (AUL) feature is the same as the Hot Line feature.

**Note 2:** If your main DN is a Hot Line, lift the handset. The Hot Line dials the number automatically.

## Make an Intercom call

The **Intercom** feature connects a group of people together through an Intercom Key. You can use the Intercom feature to call a member of your intercom group by pressing a code assigned to each member of the group. The intercom group must be set up by your network administrator.

To make an Intercom call:



Intercom



1. Lift the **handset**.
2. Press the **Intercom** Key.
3. **Dial** the one or two digit code for the intercom group member you wish to call.

To answer an Intercom call while on a line other than your Intercom group line:



or



1. Press the **Hold** Key to put the current call on hold.
- or
- Press the **Goodbye** Key to end the call.

Intercom



2. Press the **Intercom** Key and begin to speak.

## Answer a call

When you receive an incoming call, your telephone rings and the LCD indicator flashes.

To answer a call:



or



or

2498



or



Lift the **handset**.

or

Press the **Handfree** Button located on the left side of the handset (M3902, M3903, and M3904).

or

Press the **Line** (DN) Key beside the LCD indicator as it flashes.

or

Press the **Headset** Key when using a headset.



## While on an active call

This section describes features that you can use while on an active call.

### Place a call on Hold

Use the **Hold** feature when you are on the line with one party and a second call comes in on a second line. You can answer the second call and retain the original call by putting it on Hold.

To place a call on Hold:



Press the **Hold** Key. The LCD indicator flashes beside the line on hold.

**Note 1:** If the Automatic Hold feature is configured for your Meridian 1, the active call is automatically put on Hold when you answer the second call.

**Note 2:** On the Meridian SL-100 Automatic Hold is the default feature.

**Note 3:** The caller hears music while on hold, if the Music on Hold feature is configured for your system.

To retrieve a call on hold:



Press the **Line** (DN) Key beside the flashing LCD indicator.

### Transfer a call

The **Transfer** feature is used to redirect a call to the appropriate person.

To use the **Transfer** feature to direct a call to a third party.

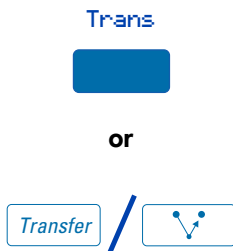

1. On the **M3903** and **M3904**, press the **Transfer** Soft Key. The other party is on hold and you receive dial tone. The LCD indicator light flashes steadily.  
or

On the **M3902**, press the fixed **Transfer** Key



Trans



or



To go back to the original call, if the transfer is incomplete:

2498



2. **Dial** the number where you are transferring the call.
3. When you hear the ring or a person answers, press the **Transfer** Key to complete the call transfer.

The LCD indicator goes from steady on to off.

If the person you called is not available: Press the **Line** (DN) Key next to the LCD indicator, to reconnect to the original call.

**Note:** On the Meridian SL-100, press the Transfer Key, dial the number and press the Goodbye Key. If you press the Transfer Key the second time you get a three way conference.

## Use Timed Reminder Recall

**Timed Reminder Recall** gives you a reminder tone when a call you transferred is not answered.

To use Timed Reminder Recall:

Trans



1. Press the **Transfer** Key. The call is put on hold.
2. **Dial** the number where you want to transfer the call.

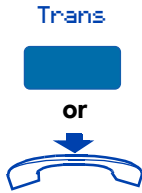

3. Press the **Transfer** Key again.

or

Replace the **handset** before the extension answers. This starts the recall timer.

**Note 1:** On the Meridian SL-100, do not press the Transfer Key again; replace the handset before the extension answers. Meridian SL-100 uses the Blind Transfer Recall feature.

**Note 2:** If the transfer is complete, the recall timer stops.

If the transferred call is not answered, your telephone rings:



1. Lift the **handset**.
2. Press the **Transfer** Key and repeat the transfer (to a different DN).

**Note:** If you transfer a call to a person and they pick up the line while you are still on the line, press the Goodbye Key to complete the transfer. Check with your network administrator to determine the time interval of your recall timer.

## Use Attendant Recall

The **Attendant Recall** feature allows you to contact an attendant while on a call and connect the call to the attendant.

To contact the attendant while on a call:



1. Press the **Attendant Recall** Key while on a call.

Stay on the line until the attendant answers.



2. Press the **Goodbye** Key. The caller remains connected to the attendant.

**Note:** On the Meridian SL-100, the Attendant Recall Key is not available; use the Transfer Key to connect a call to the attendant.

## Use Call Park

---

**Call Park** allows a call to be held temporarily and retrieved from any telephone. You can park an incoming call and page the called party. When you use Call Park you do not tie up a line. Your network administrator can set up a System Park DN where most calls are automatically parked.

If configured network wide, Call Park can be used across networks.

**To Park a call on the System Park DN or your own DN:**



While on an active call, press the **Park** Key.

If there is a System Park DN, the call automatically parks on the System Park DN. Otherwise, it parks on your DN.

**Note:** On the Meridian SL-100, press the Park Key and you receive a confirmation tone. Press the Park again or the Goodbye Key.

**To park a call on a DN other than the System Park DN or your own DN:**



1. Press the **Park** Key.
2. **Dial** the DN where you want to park the call.
3. Press the **Park** Key.

**Note:** On Meridian SL-100, press Directed Call Park (DCPK) Key. Dial the DN where you want to park the call. Press DCPK again.

To park a call using the SPRE code or FFC/FAC:

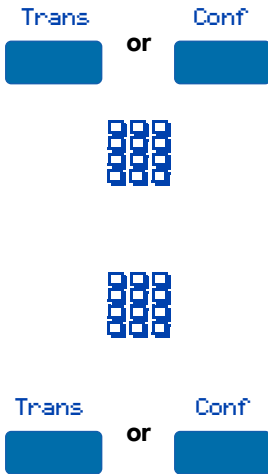

1. Press the **Transfer** Key or press the **Conference** Key.
2. **Dial** the SPRE code followed by **7 1** or, **dial** the Call Park FFC (Meridian 1), or the Call Park FAC (Meridian SL-100).
3. If you do not want the System Park DN or your own DN, **Dial** a DN where you want to park the call.
4. Press the **Transfer** Key or press the **Conference** Key.

**Note:** On the Meridian SL-100, press the Transfer Key. Do not press the Conference Key.

To retrieve a parked call:



1. Lift the **handset**.
2. If you parked the call using the SPRE code or FFC/FAC; **Dial** the SPRE code followed by **7 2** or, **dial** the Call Park FFC (Meridian 1), or the Call Park FAC (Meridian SL-100).
3. **Dial** the DN where you parked the call.

**Note:** If a parked call is not retrieved within a specified period of time, it rings back to your telephone or to the attendant. Check with your network administrator to determine your specified period of time.

## Record a Calling Party Number

---

**Calling Party Number** allows you to record a caller's number, for accounting purposes, while on an established call.

To record a caller's number:

CParty



CParty



1. While on an active call, press the **Calling Party** Key. Enter number appears on the display.
2. **Dial** the calling party's telephone number.
3. Press the **Calling Party** Key.

## Display incoming calls

---

The **Display** Key allows you to be on an active call and display an incoming caller's name and/or number, if not automatically displayed, without interfering with the call in progress.

To view the name of a second caller while on a call in progress:

Display



2498



1. Press the **Display** Key.
2. Press the flashing **Line** (DN) Key. The call waiting information appears on the display.

**Note 1:** Use of the Display Key does not interfere with the call in progress.

**Note 2:** You can use the Display Key in combination with other feature keys to display information associated with the feature.

**Note 3:** On the Meridian SL-100, while on an active call, press the Inspect Key to view information on an incoming call.

## Trace a Malicious call

Malicious Call Trace provides a way for you to trace nuisance calls within your system.

To use Call Trace while you are on a call:

CallTrace 

Press the **Call Trace** Key.

**Note:** On the Meridian SL-100, press the Malicious Call Hold (MCH) Key.

To use Call Trace if you do not have a trace button:

Trans  or  Conf

1. Press the **Transfer** Key **or** the **Conference** Key.

**Note:** On the Meridian SL-100, press only the Transfer Key.



2. **Dial** the Trace FFC (Meridian 1 system) **or** the Trace FAC (Meridian SL-100 system).

2498  

3. Press the **Line** (DN) Key beside the flashing LCD indicator to return to the call.

## Incoming calls

This section describes features that you can use with incoming calls.

### Activate Automatic Answerback

---

When **Automatic Answerback** is active, your set automatically answers in handsfree mode after one ring.

**Note:** When Automatic Answerback is active, calls do not forward to your voice message service.

To use Automatic Answerback:



Press the **Automatic Answerback** Key.

To deactivate Automatic Answerback:



Press the **Automatic Answerback** Key.



## Activate Call Pickup

**Call Pickup** allows you to pick up a call from any telephone in the same Pickup Group or another Pickup Group.

**To answer a call in your own Call Pickup Group:**



Pickup



1. Lift the **handset**.
2. Press the **Pickup** Key.

**To answer an incoming call in another Call Pickup Group:**



GrpPickup



1. Lift the **handset**.
2. Press the **Group Pickup** Key.
3. **Dial** the Pickup Group number of the telephone that is ringing.

**Note 1:** The network administrator assigns the Pickup Group code.

**Note 2:** This feature is not applicable on the Meridian SL-100 system.

**To answer a call at a specific extension within your Pickup Group:**



DNPickup



1. Lift the **handset**.
2. Press the **DN Pickup** Key.

**Note 1:** The Meridian SL-100 uses the Directed Call Pickup Feature Access Code (FAC).

**Note 2:** If the pickup DN is invalid, you receive an overflow burst tone, and the screen displays *Release and try again*. Press the **Goodbye** Key.

## Use Call Waiting

**Call Waiting** puts your current call on hold, while you answer an incoming call. Example: The attendant routes an outside call to you while you are on an existing call. Call Waiting allows you to recognize the call and respond to it. This feature must be enabled by your network administrator.

**To answer an incoming call while on another call:**



1. Press the **Hold** Key when you hear the tone. The Call Waiting status icon appears in the display.
2. Press the **Call Wait** Key (**CWait** for **M3902**) to answer the call.

**To return to your first telephone call:**



or



1. Press the **Hold** Key, if you want to put the second call on hold.
- or

Press the **Goodbye** Key to end the second call.

2. Press the **Line** (DN) Key associated with the first call.

**If you do not have a Call Waiting Key:**



1. If you do not have a Call Waiting Key and you hear the Call Waiting tone, press the **Goodbye** Key to end your current call.
2. Press the **Line** (DN) Key beside the flashing status icon to answer the incoming call.

## While you are away from your desk

This section describes features that you may wish to use when you are away from your desk.

### Forward calls

---

**Call Forward** allows you to direct your calls to ring at another DN. If the telephone is in the process of ringing, you cannot forward that call.

To forward your calls or change the forward number:

Forward



Forward



1. Press the **Forward** Key.
2. **Dial** the DN where you want to forward your calls.
3. Press the **Forward** Key.

To cancel Call Forward:

Forward



Press the **Forward** Key.

To reinstate Call Forward to the same number:

Forward Forward



Press the **Forward** Key Twice.

### Forward internal calls only

---

**Internal Call Forward** allows only calls originating at internal DNs to ring at another DN. Calls originating outside your Meridian 1 system will still ring at your telephone. You cannot forward calls while your telephone is ringing.

To forward your internal calls:

IntForward



1. Press **Internal Call Forward** Key.



Int.Forward  

2. **Dial** the DN where you want to forward your calls.
3. Press the **Internal Call Forward** Key.

**To cancel Internal Call Forward:**

Int.Forward  

Press the **Internal Call Forward** Key.

**To reinstate Internal Call Forward to the same number:**

Int.Forward 

Press the **Internal Call Forward** Key twice.

Int.Forward  

**Note:** The Meridian SL-100 uses Call Forward Busy/Don't Answer Internal/External Feature. This feature allows Meridian SL-100 users to:

- Forward an incoming call which originated internally from a DN in the same customer group as you
- Forward an incoming call which originated externally from a DN out of your customer group to a DN outside your customer group.

You can activate this feature by using a Feature Access Code (FAC).

## Use Remote Call Forward

---

The **Remote Call Forward** feature allows you (from any telephone other than your own) to forward your calls to any telephone.

**Note:** On the Meridian SL-100, dial the Remote Access Directory Number. You are prompted to enter the directory number of your telephone and dial the Call Forwarding Remote Feature Activation Code. This allows you to activate, deactivate, or change call forwarding to a new destination.

To activate Remote Call Forward:



1. Lift the **handset**.
2. If you call from a telephone outside the system, first **dial** your direct system access number and wait for dial tone.
3. **Dial** the Remote Call Forward FFC to activate the feature.
4. **Dial** your Electronic Lock password.

**Note:** Refer to “Secure your telephone” on page 38.

5. **Dial** your DN.  
You get a dial tone before you dial your number.
6. **Dial** the number where you want to forward your calls. If you forward calls to an invalid number, you receive a fast busy.
7. Press the  Key.  
To forward calls to a previous call forward telephone number, skip step six above.

To cancel Remote Call Forward:



1. Lift the **handset**.
2. If you call from a telephone outside the system, **dial** the Direct Inward System Access number and wait for the dial tone.
3. **Dial** the FFC deactivate key code for Remote Call Forward.



4. **Dial** your Electronic Lock password.
5. **Dial** your DN.  
You get a **dial** tone before you dial your number.
6. Press the  Key.

## Secure your telephone

---

You can **Secure** (lock) your telephone with a password so that no one can make calls from your office. The lock consists of a password which you may change.

To lock your telephone:



1. Lift the **handset**.
2. **Dial** the Lock Flexible Feature Code (FFC) and your Electronic Lock Password.

**Note:** If you perform this operation from someone else's telephone, dial your DN.

3. Press the **Goodbye** Key.

To unlock your telephone:



1. Lift the **handset**.
2. **Dial** the Unlock Flexible Feature Code (FFC) and your Electronic Lock Password.

**Note:** If you perform this operation from someone else's telephone, dial your DN.

3. Press the **Goodbye** Key.

To change your password:



1. Lift the **handset**.
2. **Dial** the Password Change Flexible Feature Code (FFC) and your current password. **Dial** your new password twice (for verification).
3. Press the **Goodbye** Key.

**Note 1:** This feature is not available on the Meridian SL-100.

**Note 2:** You cannot change your password from a remote set.

## Talk with more than one person

This chapter describes features which allow you to talk with more than one person at the same time.

### Set up a Conference call

---

You can set up a **Conference call** for three (or six) people, this includes yourself. Contact your network administrator to find out the maximum number of people you can join in a conference on your system.

To set up a conference call:



1. Press the **Conference** Key while you are on a call. The other party is on hold and you receive a dial tone.
2. **Dial** the number of the person you want to add to the conference.
3. Press the **Conference** Key when the person answers. Everyone is able to join the conversation.

If the person you attempt to add to the conference is unavailable:



1. Press the **Goodbye** Key.
2. Press the **Line** (DN) Key with the flashing icon to return to your original call.

### .Join a call

---

To connect a call on hold (on a different line) to your current call:



1. Press the **Conference** Key.
2. Press the **Key** that has the caller you want to connect to your current call.



Conf



3. Press the **Conference** Key again.

The person on hold joins your conversation.

## Selectable Conferee Display and Disconnect

You can view the list of active conferees by using the **Conferee Selectable Display** Key and disconnect any party that has been added to the conference call. This feature is not available on the Meridian SL-100 system.

To view active conferees:

ConfSe1Dsp



1. While on a conference call, press the **Conferee Selectable Display** Key. The LCD indicator turns on. With each key press, the screen changes to show a different active conferee.

**Note:** This action has no effect on the displays of the other telephones involved in the conference.



2. Press the **Goodbye** Key. If configured, the Conference Count Display returns. The LCD indicator turns off.

To disconnect a conferee:

ConfSe1Dsp



1. While on a conference call, press the **Conferee Selectable Display** Key. The LCD indicator turns on. Continue to press the key until the conferee you want to delete appears on the screen.

2498



2. Press the **Line (DN)** Key on which the conference call is established. The selected conferee is disconnected from the call.

**Note:** If there are additional conferees to be disconnected, press the **Conferee Selectable Display** Key until the conferee that is to be disconnected is displayed on the screen.



3. Press the **Goodbye** Key. If configured the Conference Count Display returns and is updated to reflect the revised total count of conferees. The LCD indicator turns off.

## Use Group Call

---

**Group Call** automatically calls members of a predefined group, one at a time, until they all answer. Ask your network administrator for details on how to create a conference call group.

**Note:** On the Meridian SL-100, use the Preset Conference feature for group calls. Dial the specific DN for Preset Conference, simultaneous ringing of the pre-selected parties is activated.

To call group members:



GroupCall



1. Lift the **handset**.
2. Press the **Group Call** Key. The feature automatically calls all group members. The icon flashes until all members answer.

Their phone numbers appear on the display as they answer. When the last person answers, the **Group Call** indicator lights steadily.

**Note:** After all the people in the group have answered, only the person who made the group call can put the call on hold.

To answer a Group Call:

GroupCall



Press the **Group Call** Key or Multiple Appearance DN (MADN) Key.

**Note 1:** If you are on a call and you receive three short tones, this is the notification of a group call on your DN.

**Note 2:** If you are on a call on another telephone in your group, you receive a long tone through the handset or speaker.

**Note 3:** You do not get a notification of a group call if you are already on a conference or group call.

### To end a Group Call:



Press the **Goodbye** Key.

**Note:** When the person who made the group call disconnects, the call terminates for all members of the group. However, the members of the Group Call can disconnect from the call and not affect other members on the call.

## Work without interruption

This chapter describes features that provide you with uninterrupted work time.

### Activate Make Set Busy

---

**Make Set Busy** allows you to make your telephone appear busy to all callers.

To activate **Make Set Busy**:

MakeSetBsy



Press the **Make Set Busy** Key.

To deactivate **Make Set Busy**:

MakeSetBsy



Press the **Make Set Busy** Key a second time to deactivate the feature.

## Additional Call Features

### Auto Dial Transfer Feature

---

**Auto Dial Transfer** allows you to use your Auto Dial Key to transmit digits to the central office after a Trunk Switchhook Flash. You must be on a central office/exchange (CO) trunk call from or to a CO which offers Centrex or exchange line-type features.

To use Auto Dial Transfer when you pick up an incoming trunk call:

CentrexSHF



AutoDial



1. Press the **Centrex Switchhook Flash** Key and wait for interrupted dial tone.
2. Press the **Auto Dial** Key to call the number desired.
3. Press the **Goodbye** Key to end the call.

**Note:** On the Meridian SL-100, Auto Dial can be used to transfer calls however, you do not have to be on a central office trunk call, and the Centrex Switchhook Flash key is not applicable to the Meridian SL-100.

### Use the buzz signal

---

**Buzz** allows one person, whose telephone is linked to another telephone, to signal the other telephone. The person signaled hears a buzz. Use this feature to notify the other person of a call, a visitor, or a request.

To buzz the telephone linked to yours:

Buzz



Buzz



1. Press the **Buzz** Key.  
The telephone linked to yours, buzzes as long as you hold down the key.
2. When you are finished, release the **Buzz** Key.

**Note:** Buzz signal is not available on the Meridian SL-100.

### Call Page to make an announcement

---

**Call Page** allows you to make an announcement over the page system. To make a page call, dial the page trunk access code.

**Note:** When the Page Key is used on an attendant console it overrides the telephones; the telephones are disconnected and must re-access the page trunk.

To connect to the page system:



1. Lift the **handset**.
2. **Dial** the page trunk access code.  
The connection to the page system is complete.
3. Make your announcement.

To disconnect from the page system:



Press the **Goodbye** Key.

### Centrex/Exchange Switchhook Flash

---

**Centrex/Exchange Switchhook Flash** allows you to signal the Central Office/Exchange (CO) during an established call to use a Centrex service such as call transfer or three-way calling.

To use Centrex/Exchange Line Switchhook Flash:

CentrexSHF



1. Press the **Centrex Switchhook Flash** Key. You receive special dial tone.
2. **Dial** the codes for your custom Centrex feature.
3. Press the **Goodbye** Key to end the call.

**Note:** The Meridian SL-100 is a central office based PBX, and this feature is not available.



## Charge a call or Forced Charge a call

**Call Charge** allows you to charge a call to a specific account. **Forced Charge** allows you to charge long-distance calls from a telephone restricted to local calls.

**Note:** On the Meridian SL-100, the account code allows a user to enter a billing number. If the account code is required, the user is prompted to enter a code by a tone after the telephone number is dialed. If a user wishes to voluntarily enter an account code, then flash the switchhook and enter the feature code, which is provided by your network administrator.

To charge a local or long-distance call to an account before you dial:

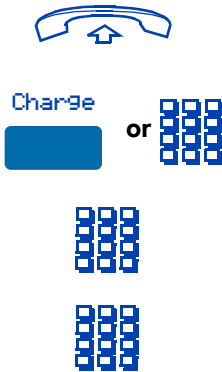

1. Lift the **handset**.
2. Press **Charge** Key or **dial** the SPRE code followed by **5** or, **dial** the Call Detail Recording FFC.
3. **Dial** the charge account number.
4. When you receive dial tone, **dial** the number.

To charge a call in progress:

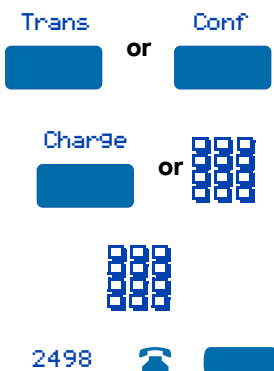

1. Press the **Transfer** Key or the **Conference** Key.
2. Press **Charge** Key or **dial** the SPRE code followed by **5** or, **dial** the Call Detail Recording FFC.
3. **Dial** the charge account number.
4. Press the **Line** (DN) Key to return to your call.

To charge a call to an account when you transfer a call:

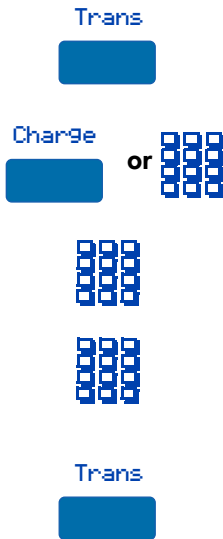

1. Press the **Transfer** Key. The call is on hold.
2. Press **Charge** Key or **dial** the SPRE code followed by **5** or, **dial** the Call Detail Recording FFC.
3. **Dial** the charge account number.
4. After you receive dial tone **dial** the number to where the call is to be transferred.
5. Press the **Transfer** Key when you hear the telephone ring.

**Note:** You can talk privately to the person at the transfer number before you press the Transfer Key.

To charge a call to an account when you add someone to a conference call:

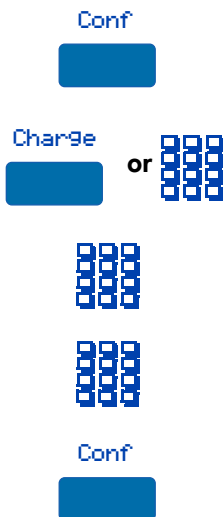

1. Press the **Conference** Key. The call is on hold.
2. Press **Charge** Key or **dial** the SPRE code followed by **5** or, **dial** the Call Detail Recording FFC.
3. **Dial** the charge account number.
4. **Dial** the number of the person you want to add to the conference.
5. Press the **Conference** Key.



## Enhanced Override Feature

---

**Enhanced Override** allows you to override an active call after you have attempted a Forced Camp-on. Use Enhanced Override when you make either a simple call or a consultation call (i.e., place a call on hold and call another party).

To use Enhanced Override:



Override



Override



1. **Dial** a telephone number and receive a busy signal.
2. Press the **Override** Key or dial the Override FFC to initiate a Forced Camp-on.  
  
If either of the persons on the call disconnects at this time you receive an overflow (fast busy/engaged) signal.
3. Press the **Override** Key again.  
  
The people on the call in progress receive a tone for approximately one second; the feature connects the three of you together. If anyone disconnects, the other two persons will remain connected.

To end the connection:



Press the **Goodbye** Key.

**Note:** Enhanced Override is not available on the Meridian SL-100.

## Forced Camp-on

---

**Forced Camp-on** allows your telephone to automatically ring another telephone as soon as that telephone disconnects from its current call. Forced Camp-on allows you to camp-on both internal and external calls. Forced Camp-on can be used as a feature by itself or in conjunction with Priority Override. The combination of the two features is referred to as Enhanced Override.

### To use Forced Camp-on:



Override



1. **Dial** a telephone number and you receive a busy signal.
2. Press the **Override** Key, or dial the Override FFC on the Meridian 1 or the Override FAC on the Meridian SL-100, to initiate a Forced Camp-on.

**Note:** The person you called hears a tone, and you hear ring/ringback signal or busy/engaged signal (depending on the options chosen). You are now camped-on to the number you dialed.

3. When the person you called finishes their call, your telephone automatically dials the number. Both your telephone and their telephone ring.

### To answer a camped-on call:



1. Press the **Goodbye** Key.
2. When the telephone rings, lift the **handset**. You are connected to the camped-on caller.

**Note:** Your telephone can be programmed for either Camp-on or Call Waiting, but not both.

**Note:** Forced Camp-on is not available on Meridian SL-100.

## Override Feature

---

You can **Override** a busy signal and interrupt another call. **Note:** This feature is called Busy Override on the Meridian SL-100.

### To override a busy/engaged signal:



1. **Dial** a telephone number and receive a busy signal.

Override



2. Press the **Override** Key, or dial the Override FFC on the Meridian 1 or the Override FAC on the Meridian SL-100.

The people on the call in progress receive a tone for approximately one second; the feature connects the three of you together. A short tone repeats every sixteen seconds.

To end the connection:



Press the **Goodbye** Key.

## Privacy Release Feature

**Privacy Release** allows one or more people who share your DN to join your call.

To use **Privacy Release** while on an established call:

PrivacyRelease



Press the **Privacy Release** Key while you are on a call. Other persons can now join the call, if they press the shared Line (MADN) Key on their telephone.

## Radio Page Feature

Some telephone systems can have an on-site **Radio Page** system. This system feature allows you to page a person and stay on the line until they answer. The paged person answers the call when they enter a special Page "Meet - me" code from any telephone. This connects the person paged to the party who paged them.

**Note:** On the Meridian SL-100, dial the paging number access code. A network connection is established with the paging access trunk. This provides access to loudspeaker paging equipment. Automatic Pre-selection, Automatic Post-selection, and Special Radio page features do not apply to Meridian SL-100.

To use **Automatic Pre-selection** ("Meet - me" page):



1. Lift the **handset**.



2. **Dial** the Radio Page FFC. You receive page dial tone.
3. **Dial** the number of the party you want to page. After you dial, you receive a ringback tone.

**Note 1:** The person you paged uses any telephone to enter a Radio Page Answer code, plus their own DN. This action connects you and the person paged.

**Note 2:** If your call goes unanswered for a preset time period, you receive a continuous high pitched tone then silence. Press the Goodbye Key.

### To use Automatic Post selection:

The called party is either busy on the telephone or away from the desk.

To page the called party there is no need to redial the number of the called party.

RadioPage



1. Press the **Radio Page** Key. You receive a special dial tone.
2. **Dial** the Radio Page Access FFC. You receive dial tone.

**Note 1:** The person you have paged can proceed to any telephone, enter their Radio Page Answer code plus their own DN. This action connects you and the person paged.

**Note 2:** You receive a fifteen second, high pitched tone, then silence if the party paged does not answer the call within a preset time period. When you receive this signal, replace the handset or press the Goodbye Key.

### To use the Special Radio Page feature:

If you carry a Radio Pager, you receive a page indication when someone dials your DN.

If the Radio Page system is set up to function in "Meet - me" mode, you can answer the page call from any telephone. You can connect to the person who paged you.



1. Lift the **handset**.
2. **Dial** the Radio Page Answer FFC. You receive page tone.
3. **Dial** your own DN. You connect to the page caller. You receive a steady high-pitched tone, letting you know the caller has hung up.

## Voice Call Feature

You page another person or make an announcement through someone else's telephone speaker.

**To make a voice call:**



VoiceCall



Goodbye



1. Lift the **handset**.
2. Press the **Voice Call** Key.
3. Make your announcement.
4. Press the **Goodbye** Key.

**To respond to a voice call:**



Your telephone rings once and you hear the caller's voice through your speaker. Lift the **handset**.

**Note:** On the Meridian SL-100 use the Individual Page from the Group Intercom (GIC) feature. Press the GIC Key and dial the appropriate GIC number. After the first ring, press the GIC Key and a one-way connection is established. Make your announcement over the speaker.

## Hospitality features

These hospitality features are intended for hotel operations use.

**Note:** With the exception of Automatic Wake-Up, hospitality features are not available on the Meridian SL-100.

### Automatic Wake-Up

Although normally used as a hotel feature, **Automatic Wake-Up** may be useful to business users who require a timed reminder call feature. From your telephone you may program the Meridian 1 system to automatically place a call to you at a predetermined time. When you answer the call, you hear recorded music for up to thirty seconds followed by a pre-recorded announcement, or the attendant.

To enter the time for a wake-up call:



1. Lift the **handset**.
2. **Dial** the Wake-Up Request FFC on the Meridian 1 or the Wake-Up Request FAC on the Meridian SL-100.
3. **Dial** the wake-up time in a 24-hour format (hhmm).
4. Press the **Goodbye** Key.

**Note:** On the Meridian SL-100, after you enter the FAC, you receive a second dial tone. Enter four consecutive digits to specify an hour and minute. The reminder time is specified in 24 hour format. (i.e., for 6:00 PM, input 1800.) You receive a confirmation tone.

To cancel a wake-up call:



1. Lift the **handset**.
2. **Dial** the Wake-Up Cancel FFC on the Meridian 1 or the Wake-Up Cancel FAC on the Meridian SL-100.



To verify the time for the wake-up call:



3. Press the **Goodbye** Key.

**Note:** On the Meridian SL-100, after you enter the FAC, you receive a confirmation tone.

1. Lift the **handset**.

2. **Dial** the Wake-Up Verify FFC.

3. **Dial** the wake-up time in a 24 hour time format (hhmm). If it is correct, you receive a confirmation tone.

**Note:** This feature is not available on the Meridian SL-100. To change the specified time for a wake-up call on the Meridian SL-100, you must first deactivate the feature and then activate the feature with a new request.

4. Press the **Goodbye** Key.

**Note:** In 24-hour time format, 7:30 AM is entered as 0730; 9:45 PM is 2145.

### Message Registration

---

**Message Registration** allows you to read, change, or reset meters that log your hotel telephone calls.

**To read meters:**

MsgReg



1. Press the **Message Registration** Key.
2. **Dial** the room Directory Number (DN).

MsgReg



3. Press the **Message Registration** Key.

**To change a meter:**

MsgReg



1. Press the **Message Registration** Key.
2. **Dial** the room Directory Number (DN).
3. **Dial** the correct meter count.

MsgReg



4. Press the  Key.
5. Press the **Message Registration** Key

**To reset a meter to zero:**

MsgReg



1. Press the **Message Registration** Key.
2. **Dial** the room Directory Number (DN).
3. Press the **Star** Key.

MsgReg



4. Press the **Message Registration** Key.



## Maid Identification

**Maid Identification** makes it easier to keep track of which maids clean which rooms. The maid enters the information from the telephone in each room.

**To enter cleaning status:**

RoomStatus



RoomStatus



1. Press the **Room Status** Key.
2. **Dial** the Directory Number (DN) for the room for which the cleaning status is being changed.
3. **Dial** one of the following cleaning status codes:

1 = cleaning requested

2 = cleaning in progress

3 = room cleaned

4 = room passed inspection

5 = room failed inspection

6 = cleaning skipped

7 = not for sale

You receive interrupted dial tone.

4. Press the **\*** Key.
5. **Dial** the Maid ID. If you dial the wrong Maid ID, press the **Star** Key and redial the ID.
1. Press the **Room Status** Key.

### Room Status

---

**Room Status** lets you read the status of a room using the display.

To read the status of a room:

RoomStatus



1. Press the **Room Status** Key.
2. **Dial** the Directory Number (DN) for the room. The DN is displayed followed by a two digit code.

The first digit indicates the occupancy status:

0 = room vacant

1 = room occupied

The next digit indicates the cleaning status of the room:

1 = cleaning requested

2 = cleaning in progress

3 = room cleaned

4 = room passed inspection

5 = room failed inspection

6 = cleaning skipped

7 = not for sale

RoomStatus



3. Press the **Room Status** Key.

## Telephone display

This section summarizes the display features of the **M3902**, **M3903**, and the **M3904**. Idle display is shown in the following figures.

### M3902 display

The **M3902** display gives call status and feature information.

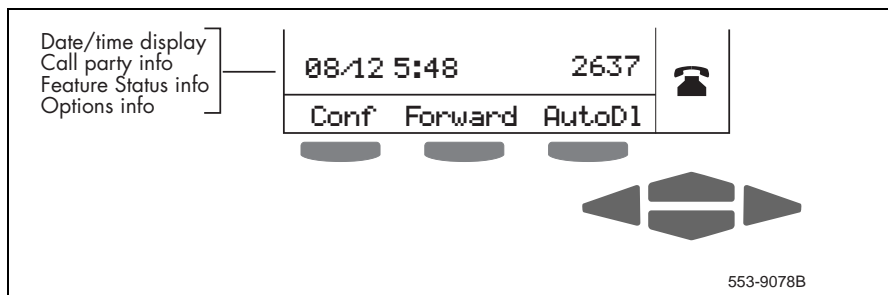

### M3903 display

The upper portion of the display on the **M3903** gives call status information, the lower display area contains a single line which displays feature information. If you are viewing a list that contains more than one item, you must use the Navigation Keys to scroll through the list. When the item you want appears, press the Select Key.

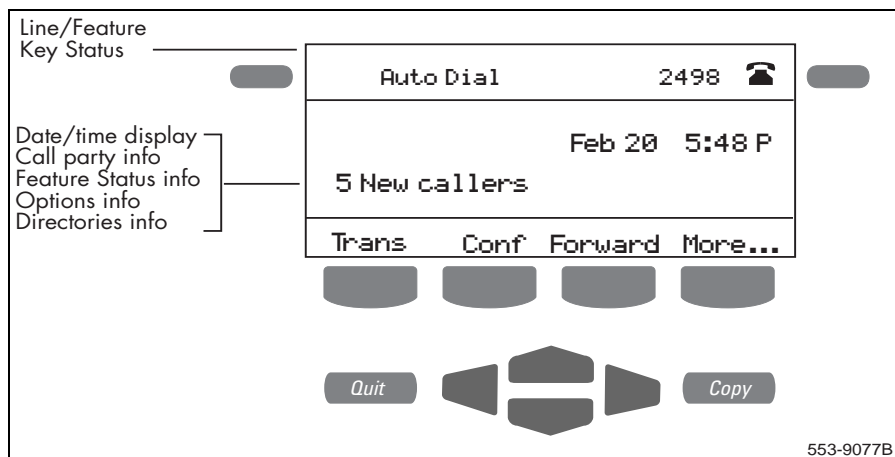

## M3904 display

The upper portion of the display on the **M3904** gives call status information, the lower display area is a three line feature information display.

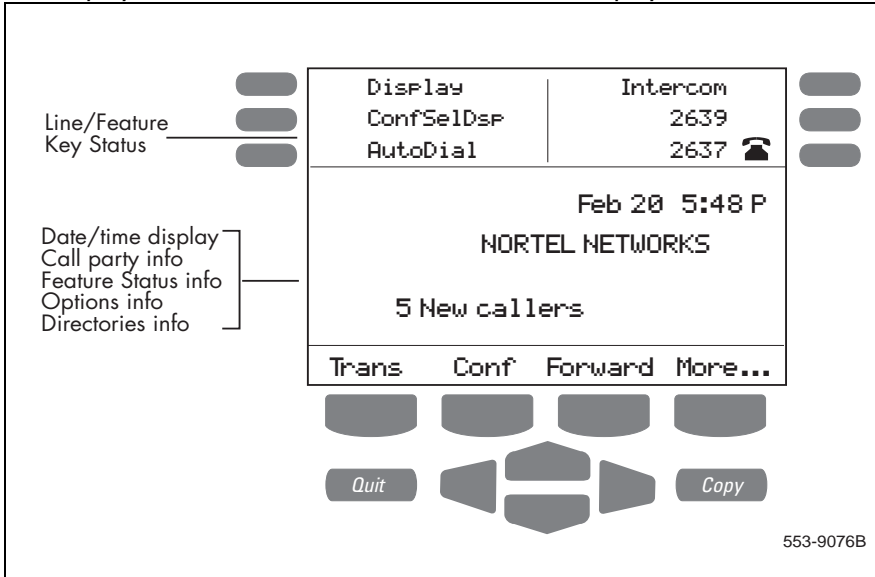

**Note:** Refer to “Your Telephone’s Controls” on page 5 and for more information on display and specialized key information.

## Options List

The **Options List** (available on the **M3902**, **M3903**, and **M3904**) allows you to customize certain characteristics of your phone. Screen prompts take you step-by-step through procedures and keep you informed on the status of the following settings: Language, Change feature key label, Screen contrast, Volume adjustment, Ring type, Call log options, Live dial pad, Preferred name match, Area code set-up, Call timer enable, Date/time format, Key click enable, Headset port on call, Headset port external alerter and recorder interface, Call indicator light, On hook default path, and Display diagnostics.

Most of the options are available to you on the **M3902**, **M3903**, and **M3904**. Some of the options are available only if turned on by your network administrator; others are designed for specific models in the M3900 series.

**To change any option's setting:**



Select



Done



Quit



or



1. Press the **Options** Key.
2. Use the **Navigation** Keys to move up or down through the options list.
3. Press the **Select** Key when the desired option is highlighted.
4. Change the option's settings. Refer to the following pages for details. The display also provides you with information to adjust your selection.
5. Press the **Done** Key to save your changes.
6. Press the **Quit** Key or **Options** Key to exit.

**Note:** If you press the **Quit** Key or **Options** Key before you press the **Done** Key, you exit the Options List without saving your changes.

## Select a language

---

The display is available in multiple languages. After you select **LANGUAGE...** from the **Options List** menu,



Deutsch

Select



1. Use the **Navigation** Keys to highlight the desired language (e.g., German).

2. Press the **Select** Key.

Press the **Done** Key to save changes. Press the **Quit** Key or **Options** Key to exit.

## Change a Feature Key label

---

You can change the name on the Programmable Line (DN)/Feature Keys (self-labeled). These keys are located on both sides of the top portion of the display area.

**To change a Feature Key label:**



Change feature key label

Select



Select



AutoDial



1. Use the down **Navigation** Key to highlight Change feature key label.

2. Press the **Select** Key.

This action takes you to the **Feature Key** menu and highlights Change feature key label.

3. Press the **Select** Key again.

The prompt asks you to select the key you want to change.

4. Press the **Programmable Line/Feature** Key whose label you want to change, (e.g., AutoDial).



Case



5. Press the **Dial Pad** Key that is printed with the first letter in your new label. Press the key until the correct character appears.
6. Use the **Case** Key to change the case of the letter, as needed.
7. Press the right **Navigation** Key once to move the cursor (so you can enter the next letter) when the desired letter appears.
8. Repeat steps 4, 5, and 6 until you have changed the entire label.

Press the **Done** Key to save changes. Press the **Quit** Key or **Options** Key to exit.

**Note:** For a detailed example of using the dial pad to enter text into your M3900 Series telephone, please see “Add a Personal Directory entry” on page 82.

**To restore one key label:**



Restore one key label

Select



Purchasing



1. From the **Feature Key** menu, use the down **Navigation** Key to highlight **Restore one key label**.
2. Press the **Select** Key.
3. Press the **Programmable Line (DN)/Feature** Key (self-labeled) that you want to restore to the original label (e.g., **Purchasing**).

Press the **Done** Key to return to the **Options List** menu. Press the **Quit** Key or **Options** Key to exit.

**Note:** You cannot change the label on the primary DN. You can press the Shift Key, if the label you want to change is on the second layer of Programmable Line/Feature Keys (self-labeled).

## Adjust Screen contrast

---

The **Screen contrast** option allows you to adjust the contrast of the display on your telephone. After you select **Screen contrast** from the **Options List** menu;

Lower



or

Higher



From the **Contrast** screen, press **Lower** to decrease the display contrast level.

or

Press **Higher** to increase the display contrast level.

Press the **Done** Key to save changes. Press the **Quit** Key or **Options** Key to exit.

## Adjust volume

---

**Note:** After you select **Volume adjustment** from the **Options List** menu, a list of adjustable items for your telephone model appears. It is recommended that you adjust these parameters while you are on a telephone call so that you can judge the impact of the changes you are making.

To adjust the **Ringer** volume:

Ringer

Lower



or

Higher



1. Select **Ringer** from the **Volume** menu.
  2. Press **Lower** to decrease the ringer volume.
- or
3. Press **Higher** to increase the ringer volume.

Press the **Done** Key to save changes. Press the **Quit** Key or **Options** Key to exit.

Use the procedure above to adjust the volume on the following items:

Buzzer

Speaker

Handset listen

Handsfree listen

Headset listen

Headset talk

Headset sidetone

**Note:** Headset sidetone (**M3904** only) is the sound of your own voice that you hear in the headset speaker.



## Choose Ring type

The **Ring type** option allows you to choose from among the various ringing sounds available for your telephone model. After you select **RING TYPE...** from the **Options List** menu;



Ring type 3

Play



Select



1. Use the **Navigation** Keys to scroll through the list of ring types.
2. Press the **Play** Key to sample a ring tone.
3. Press the **Select** Key to activate the desired ring type (**M3903** and **M3904**).

Press the **Done** Key to save changes. Press the **Quit** Key or **Options** Key to exit.

## Select Call Log options

The **Call Log options** (available on the **M3903** and **M3904**) provide a choice of logging all incoming calls, logging only the unanswered calls, or not logging any calls. The Call Log holds up to 10 different incoming entries for the **M3903** and up to 100 for the **M3904**. After you select **Call log options** from the **Options List** menu;



Log all calls

or

Log unanswered calls

From the **Log options** menu, use the **Navigation** Keys to highlight and select either:

Log all calls

or

Log unanswered calls

**Note:** New call indication must be set to On, if you want Call Log notification.

Press the **Done** Key to save selection. Press the **Quit** Key or **Options** Key to exit.

### Use Live dial pad

---

The **Live dial pad** option (available on the **M3094**) allows you to press any dial pad key to automatically access a dial tone. After you select **Live dial pad** from the **Options List** menu;

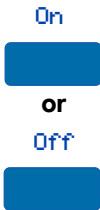

From the **Live dialpad** screen, press the **On** Key to turn on Live dial pad.

**or**

Press the **Off** Key to turn off Live dial pad.

Press the **Done** Key to save changes. Press the **Quit** Key or **Options** Key to exit.

### Select Preferred name match

---

The **Preferred name match** option (available on the **M3904**) displays the names of incoming and outgoing callers as stored in your Personal Directory, if the telephone number matches the one stored in your directory. This option allows you to personalize the displayed names for incoming and outgoing calls. After you select **Preferred name match** from the **Options List** menu;



From the **Name match** screen, press the **On** Key to turn on Preferred name match.

**or**

Press the **Off** Key to turn off Preferred name match.

Press the **Done** Key to save changes. Press the **Quit** Key or **Options** Key to exit.

## Set up area code

---

Using the **Area code set-up** option (available on the **M3904**) causes the Callers List and Calling Line ID (CLID) display show the number/extension followed by the area code/prefix in parenthesis. This makes it easier to identify local calls and internal calls. You can define up to three codes. After you select **Area code set-up** from the **Options List** menu

**1st Code: 408**

**2nd Code:**

**3rd Code:**

Use the **Navigation** keys to place your cursor in the first line and enter an **area/country code** of your choice.

**Note:** You can enter up to three codes of your choice.

Press the **Done** Key to save changes. Press the **Quit** Key or **Options** Key to exit.

## Enable Call timer

---

The **Call timer enable** option measures how long you are on each call. After you select **Call timer enable** from the **Options List** menu;

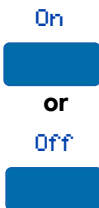

From the **Call timer** screen, press the **On** Key to turn on the Call timer.

or

Press the **Off** Key to turn off the Call timer.

Press the **Done** Key to save changes. Press the **Quit** Key or **Options** Key to exit.

## Select Date/time format

---

There are eight **Date/time formats**. Four formats are based on the 12 hour clock and four are based on the 24 hour clock. After you select **Date/time format...** from the **Options List** menu;



Use the **Navigation** Keys to scroll through the eight formats. The sample formats appear on the upper right side of the display area.

Format 3

Press the **Done** Key to select the highlighted format. Press the **Quit** Key or **Options** Key to exit.

## Enable Key click

---

The **Key click** option causes the handset or speaker to produce a clicking sound when you press the telephone keys. After you select **Key click enable** from the **Options List** menu;



From the **Key click** screen, press the **On** Key to turn on Key click.

or

Press the **Off** Key to turn off Key click.

Press the **Done** Key to save changes. Press the **Quit** Key or **Options** Key to exit.

## Use Headset port on call

---

The **Headset port on call** option (available on the **M3904**) requires that a lamp-type accessory be connected to the headset port. When the Headset port on call option is activated and the user is on a call, the lamp lights providing an indication that a call is in progress. After you select **Headset port on call** from the **Options List** menu;



From the **On call** screen, press the **On** Key to turn on Headset port on call.

or

Press the **Off** Key to turn off Headset port on call.

Press the **Done** Key to save changes. Press the **Quit** Key or **Options** Key to exit.

**Note:** Additional equipment is required to implement this option. For more information please contact your Nortel Networks distributor.

## Activate Headset port external alerter

---

When the **Headset port external alerter** option (available on the **M3904**) is activated, it supports a visual or audible alerter and/or recorder device. This device plugs into the Headset port, which is located on the bottom of the telephone. After you select **Headset port ext. alerter** from the **Options List** menu;



From the **Ext alerter** screen, press the **On** Key to turn on Headset port external alerter.

or

Press the **Off** Key to turn off Headset port external alerter.

Press the **Done** Key to save changes. Press the **Quit** Key or **Options** Key to exit.

**Note:** Additional equipment is required to implement this option. For more information please contact your Nortel Networks distributor.

## Use Call indicator light

---

The incoming call indicator light can be controlled on the **M3904**. After you select **Call indicator light** from the **Options List** menu;



From the **Indicator** screen, press the **On** Key to turn on Call indicator light.

or

Press the **Off** Key to turn off Call indicator light.

Press the **Done** Key to save changes. Press the **Quit** Key or **Options** Key to exit.

## Set On-hook default path

---

The **On-hook default path** option (available on the **M3903** and **M3904**) automatically opens the voice path on either the Headset or on Handsfree when you press a Line (DN) Key. After you select **On hook default path** from the **Options List** menu;



Handsfree selected

or

Headset selected

From the **On hook path** menu, use the **Navigation** Keys to highlight and select either:

Handsfree selected

or

Headset selected

Press the **Done** Key to save selection. Press the **Quit** Key or **Options** Key to exit.

## Display diagnostics

---

The **Display diagnostics** option tests the functionality of your telephone's display screen and indicator lights. This option also provides information on the firmware currently in use on your M3900 series telephone. After you select **Display diagnostics** from the **Options List** menu;



Use the up or down **Navigation** Keys to scroll through the list and view the changing display screens.

Press the **Done** Key to return to the **Options List** menu. Press the **Quit** Key or **Options** Key to exit.

## Control Group Listening

---

The **Group Listening** feature enables you to talk on the handset to one party while other people listen to the conversation on your telephone's speaker. The network administrator must enable this feature. After you select **GROUP LISTENING** from the **Options List** menu;

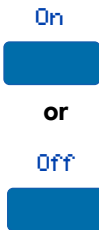

From the **Group listening** screen, press the **On** Key to turn on Group listening.

or

Press the **Off** Key to turn off Group listening.

Press the **Done** Key to save changes. Press the **Quit** Key or **Options** Key to exit.

**Note 1:** The Group listening selection will not appear in the Options List menu of your telephone unless this feature has been activated by your network administrator.

**Note 2:** This feature does not have a tone to inform the party on the other end of the call that the conversation is being monitored. You must tell the other party that others are listening to the conversation.

# Directory display and navigation

## M3903 Directory display and navigation

The M3903 information display shows one item at a time. Use the Navigation Keys to scroll through the list. When the item you want appears, press the Select Key. The figure below shows the status once you log into the directory. The M3903 has a Call Log and Redial list. It does not have a Personal Directory.

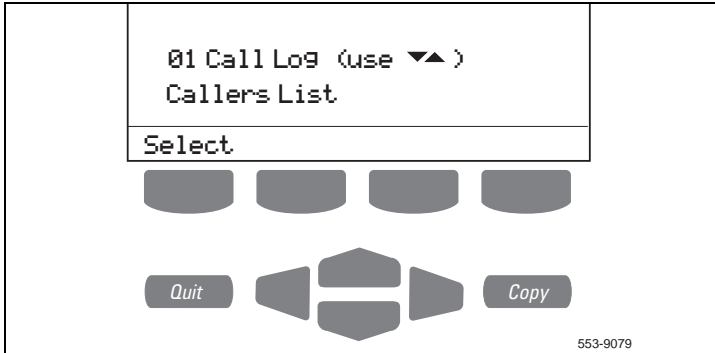

## Access your Callers List or Redial List (M3903)

To access the M3903 Call Log:

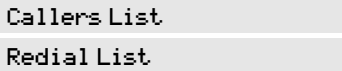

Select



1. Press the **Call Log** Key.
2. Use the **Navigation** Keys to highlight the log that you want to view.
3. Press the **Select** Key.

To exit the M3903 Call Log:



or



Press the **Quit** Key or the **Call Log** Key to exit.



## M3904 Directory display and navigation

With the **M3904**'s display, you can view three lines of information. The figure below shows the status once you log into the directory.

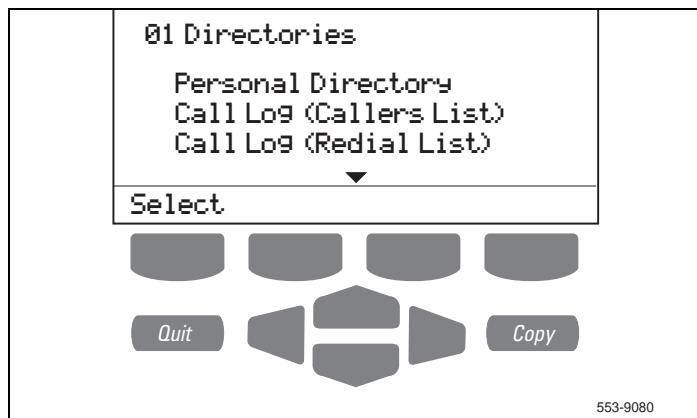

### Access your Call Log, Redial List, or Personal Directory (M3904)

To access the M3904 Directory/Log:



Select



1. Press the **Directory/Log** Key.
2. Use the **Navigation** Keys to highlight the Personal Directory or the Call Log that you want to view.
3. Press the **Select** Key.

To exit the M3904 Directory/Log:



or



Press the **Quit** Key or the **Directory/Log** Key to exit.

### Directory password protection (M3904)

---

You can password protect your Personal Directory, Callers List, and Redial list on the **M3904**. If password protection is activated, you will be asked to enter your password each time you press the Directory/Log Key.

To enable password protection:



#### Password Administration

Select



Select



On



Enter



1. Press the **Directory/Log** Key.
2. From the **Directories** menu, use the **Navigation** Keys to highlight **Password Administration**.
3. Press the **Select** Key. The **Passwd Admin** menu appears with **Password enabled: OFF** highlighted.
4. Press the **Select** Key again to select **Password enabled: OFF**.
5. Press the **On** Key to enable password protection.
6. **Dial** the password.
7. Press the **Enter** Key.
8. **Dial** the password again to confirm your password.

Enter



Done



Quit



or



To disable Personal Directory password:



Enter



Password Administration

Select



Select



Off



9. Press the **Enter** Key.
  10. Press the **Done** Key to save changes.
  11. Press the **Quit** Key or the **Directory/Log** Key to exit.
1. Press the **Directory/Log** Key.
  2. **Dial** the password.
  3. Press the **Enter** Key.
  4. Use the **Navigation** Keys to highlight **Password Administration**.
  5. Press the **Select** Key. The **Passwd Admin** menu appears with **Password enabled: ON** highlighted.
  6. Press the **Select** Key again to select **Password enabled: ON**.
  7. Press the **Off** Key to disable password protection.

Done



Quit

or

Directory/Log



8. Press the **Done** Key to save changes.
9. Press the **Quit** Key or the **Directory/Log** Key to exit.

## Call Log

The **Call Log** (available on the **M3903** and **M3904**) records the name and number of incoming and outgoing calls and can be password protected on the **M3904**. You can activate Call Log to record all calls, record only the unanswered calls, or record no incoming calls.

The **Callers List** stores incoming calls, and the **Redial List** stores outgoing calls in order of date and time received/made. The oldest call is stored at the top of the list. The newest call is stored at the bottom of the list.

The **M3904** Call Log list holds up to 100 entries for incoming and 20 entries for outgoing calls. The **M3904** can copy a number from the Callers List or Redial List and store it in the Personal Directory.

The **M3903** Call Log list holds up to 10 entries for incoming and 5 entries for outgoing calls.

### Access and use the Callers List (M3903)

To access your Call Log:



Callers List

Select



New



or

Old



1. Press the **Call Log** Key.
  2. Use the **Navigation** Keys to highlight Callers List.
  3. Press the **Select** Key.
  4. Press the **New** Key to go to the top of the new calls list.
- or
- Press the **Old** Key to go to the top of the old calls list.

To make a call from the Callers List:



2498

Dial



To exit the Callers List without making a call:

Quit

or

Call Log



Press the **Quit** Key or the **Call Log** Key to exit.

1. Use the **Navigation** Keys to scroll through the Callers List and highlight the number you want to call.

**Note:** If you are calling an external or long distance number, you will need to edit the number to add the access codes required by your system to make an external or long distance call.

2. Press the **Dial** Key to call the number selected. You leave the Callers List when you make the call.

## Access and use the Callers List (M3904)

---

To access your Callers List:

Directory/Log



Call Log (Callers List)

Select



1. Press the **Directory/Log** Key.
2. Use the **Navigation** Keys to highlight Call Log (Callers List).
3. Press the **Select** Key.

New



or

Old



### To make a call from the Callers List:



2498

Dial



### To exit the Callers List without making a call:

Quit

or

Directory/Log



4. Press the **New** Key to go to the top of the new calls list.

or

Press the **Old** Key to go to the top of the old calls list.

1. Use the **Navigation** Keys to scroll through the Callers List and highlight the number you want to call.

**Note:** If you are calling an external or long distance number, you will need to edit the number to add the access codes required by your system to make an external or long distance call.

2. Press the **Dial** Key to call the number selected. You leave the Callers List when you make the call.

Press the **Quit** Key or the **Directory/Log** Key to exit.

## Redial List

The **Redial List** (available on the **M3903** and **M3904**) records your last 20 (**M3904**) or 5 (**M3903**) outgoing calls and can be password protected on the **M3904**. On the **M3904**, you can copy these numbers to your Personal Directory.

### Use the Redial List (M3903)

To access your Redial List:



Redial List

Select



2637

Dial



1. Press the **Call Log** Key.
2. Use the **Navigation** Keys to highlight Redial List.
3. Press **Select**.
4. Use the **Navigation** Keys to scroll through the Redial List and highlight the number you want to call.

**Note:** If you are calling an external or long distance number, be sure that the appropriate access codes are included.

5. Press the **Dial** Key. Your call is automatically dialed and you exit the Redial list.

### Use the Redial List (M3904)

To access your Redial List:



1. Press the **Directory/Log** Key.





Call Log (Redial List)

Select



2637

Dial



2. Use the **Navigation** Keys to highlight Call Log (Redial List).
3. Press **Select**.
4. Use the **Navigation** Keys to scroll through the Redial List and highlight the number you want to call.

**Note:** If you are calling an external or long distance number, be sure that the appropriate access codes are included.

5. Press the **Dial** Key. Your call is automatically dialed and you exit the Redial list.

## Use the Personal Directory

The Personal Directory (available on the **M3904**) provides a personalized directory of names and telephone numbers. The Personal Directory allows you to add, delete, search, and edit entries and can be password protected. The Personal Directory holds up to 100 entries (an entry is one name and one telephone number). You can add a directory entry by copying the entry from your Callers List or Redial List. You can also add entries with the "AddNew" Key or by using the Personal Directory PC Utility application. The Personal Directory PC Utility uses an accessory cartridge to connect your PC and your **M3904** telephone. You can create a directory on your Personal Computer and transfer it to your **M3904** telephone.

### Access the Personal Directory

---



Select



1. Press the **Directory/Log** Key.
2. Press the **Select** Key in the **Directories** menu to select Personal Directory.

### Add a Personal Directory entry

---

After accessing your Personal Directory:

AddNew



1. Press the **Add New** Key.
2. **Dial** the new name.

Example:

To enter the name **Chris**:



1. **Dial** the name using the key pad.

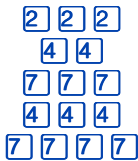

Next



To enter the number:



Done



Quit

or



2. Press the dial pad **key** with the desired letter repeatedly until that letter appears on the display.
3. Press the **right arrow** key to go to the next letter.

**Note:** The cursor automatically advances to the next position, if a different-from-last key is pressed, or after a short pause.

4. Press the **Next** Key.

1. Use the **dial pad** to enter the telephone number associated with the name entered above.

**Note:** If you are adding an external or long distance number, be sure to include the access codes required by your system to make an external or long distance call.

2. When you have finished entering all of the digits, press the **Done** Key to save the changes.
3. Press the **Quit** Key or the **Directory/Log** Key to exit.

## Add an incoming call

---



Directory



Next



or

Clear



Next



Done



Quit

or



1. Press the **Copy** Key. The displays shows the message **Copy to**.

2. Press the **Directory** Key.

3. Press **Next** to copy the incoming call without editing the name. Edit the number, if required (see note for step 4) and go to step 5.

or

Press **Clear** to make changes to the name before saving. Add the name using the **dial pad**, **Delete**, and **Case** Keys as needed.

4. Press the **Next** Key. Make changes to the telephone number if required

**Note:** If you are copying an external or long distance number, be sure to add the access codes required by your system to make an external or long distance call.

5. Press the **Done** Key to save the entry in your directory.

6. Press the **Quit** Key or the **Directory/Log** Key to exit.

**Note:** You can edit the name or number before or after you save to the directory.

## Add an outgoing call



Dirctry



Next



Done



Quit

or



1. Use the **dial pad** to enter the complete number of the other party.

**Note:** If you are dialing an external or long distance number, be sure to include the access codes required by your system to make an external or long distance call.

2. Lift the **handset**.
3. After the person you called answers, press the **Copy** Key. The displays shows COPY to.
4. Press the **Directory** Key.
5. Add the name, using the **dial pad**, **Delete**, and **Case** Keys as needed.
6. Press the **Next** Key.
7. Press the **Done** Key to save the changes.
8. Press the **Quit** Key or the **Directory/Log** Key to exit.

**Note:** You can edit the name or number before or after you save to the Directory.

## Delete or edit a Personal Directory entry

---

To delete a Personal Directory entry:



Delete



Yes



1. Use the **Navigation** Keys to highlight the entry you want to edit or delete.
2. Press the **Delete** Key to delete the currently highlighted entry in your Personal Directory.
3. Press the **Yes** Key to confirm the deletion.

To edit a Personal Directory entry:

Edit



Next



Done



Quit



or

Directory/Log



1. Press the **Edit** Key to change the telephone number or name.
2. Use the **Navigation** Keys to highlight the character you want to change.
3. Use the **dial pad** to enter the desired changes. Refer to "Add a Personal Directory entry" on page 82 for an example of how to use the dial pad to enter names.
4. Press the **Next** Key. Edit the number if necessary.
5. Press the **Done** Key to save the changes.
6. Press the **Quit** Key or the **Directory/Log** Key to exit.

## Delete your Personal Directory

---

To delete your Personal Directory:

DelList



Yes



or

No



Quit

or



1. Press the **Delete List** Key. The message **Delete all entries?** appears.
2. Press the **Yes** Key if you want to delete all the entries in your Personal Directory.  
  
or  
Press the **No** Key if you want to return to the top of the Personal Directory with no changes made.
3. Press the **Quit** Key or the **Directory/Log** Key to exit.

## Use the Personal Directory to make a call

---

To use the Personal Directory to make a call:



Purchasing

Dial



1. Use the up or down **Navigation** Keys to highlight the desired name or number.  
  
**Note:** If you are dialing an external or long distance number, be sure that your directory entry includes the access codes required by your system to make an external or long distance call.
2. Press the **Dial** Key.

## Use Card View

---

The **Card View** feature provides additional information about the Personal Directory entry.

To look at the Card View:



1. Highlight the **name**.
2. Press the right **Navigation** Key.

To dial from the Card View:



1. Use the **Navigation** Keys to show the name and number of the currently selected entry in the Card View.

**Note:** If you are dialing an external or long distance number, be sure that your directory entry includes the access codes required by your system to make an external or long distance call.

2. Press the **Dial** Key to place the call.

Dial



To exit the Card View:



1. Press the left **Navigator** Key to leave the Card View and return to the selected name.

## Search for an entry

---

You can search for a particular entry in your Personal Directory.

To search for an entry:



Personal Directory

1. Use the **Navigation** Keys to scroll through the **Directories** menu and highlight Personal Directory.

Select



2. Press the **Select** Key.





- Use the **dial pad** to enter the first letter of the name you are seeking. For example, press the **2** key twice to go to the first entry that begins with the letter "B".

## Copy a number from the Redial List

You can copy a number from the Redial List to the Personal Directory.

To copy a number from the Redial List:



2498



Directory



Next



or

Clear



Next



Done



- Use the **Navigation** Keys to highlight the name or number in your Redial List that you want to copy to your Personal Directory.
- Press the **Copy** Key.
- Press the **Directory** Key when the prompt asks **COPY to?**.
- Press **Next** to copy the incoming call without editing the name. Edit the number, if required (see note for step 5), and go to step 6.  
**or**  
Press **Clear** to make changes to the name before saving. Add the name using the **dial pad**, **Delete**, and **Case** Keys as needed.
- Press the **Next** Key. Make changes to the telephone number, if required.  
**Note:** If you are copying an external or long distance number, be sure that your directory entry includes the access codes required by your system to make an external or long distance call.
- Press the **Done** Key. The entry is saved to your Personal Directory and you are returned to the Redial List.

# M3901 Feature Operation

M3901 is a one line telephone. The M3901 operates in a different way than the other M3900 series Digital Telephones. This section explains in some detail the M3901 operation.

The M3901 supports five programmable features. You activate the features when you press the M3901 Feature Key and a dial pad number key for that feature. Your system administrator programs the features for your telephone. There is a feature card placed on your telephone, which lists the features and instructions.

## M3901 Fixed Keys

---

### Goodbye Key

To end a call:



or



Press the **Goodbye** Key to terminate a call.

or

Replace the **handset** to terminate a call.

### Hold Key

To put a call on Hold:



Press the **Hold** Key to put an active call on hold.

To take a call off Hold:



Press the **Line** (DN) Key to take the call off hold.

**Note:** When a call is on hold, the Message Waiting Call Status Indicator flashes to serve as a reminder.

## Line (DN) Key

To use the Line (DN) Key to make a call:



or



1. Press the **Line** (DN) Key and **dial** the telephone number.

or

Lift the **handset**. The Line (DN) Key is automatically selected.

2. **Dial** the telephone number.

## Volume Control Bar

Use the **Volume Control Bar** to raise or lower the volume on the ringer or handset.

To adjust the ringer volume:



While the telephone is ringing, press the right side of the **Volume Control Bar** to raise the ringer volume or press the left side of the **Volume Control Bar** to lower the ringer volume.

To adjust the handset volume (voice or dial tone):



With sound coming from the handset, press the right side of the **Volume Control Bar** to raise the handset volume or press the left side of the **Volume Control Bar** to lower the handset volume.

## Features Key



To activate a feature:



1. Press the **Features** Key.
2. **Dial** the number key assigned to the feature.

## Use a programmed feature or an Auto Dial

Your network administrator may configure up to five features for your telephone.

To access a feature requires that you to press the  /  Key and a Dial Pad Number Key assigned to the feature. After you press the Feature Key, you have 30 seconds to press a Dial Pad Number Key or the process ends.

Press the  /  Key and the  Key to turn an active feature off.

### To activate a feature:



1. Press the **Features** Key.
2. Press the **Dial Pad Number** Key associated with the feature you want to use.

### To deactivate the active feature:



1. Press the **Features** Key.
2. Press the  Key.

**Note:** The Features Card on the right side of the M3901 lists each feature and the Dial Pad Number Key used to activate the feature.

### To program an Auto Dial Key:



1. Without lifting the handset, press the **Features** Key.
2. Press the **Dial Pad Number** Key for the Auto Dial position you want to program. The Feature Activation Indicator flashes.
3. **Dial** the number you want to program to the Auto Dial position.



4. Press the **Features** Key.
5. Press the **Dial Pad Number** Key for the Auto Dial position you just programmed.

## Use Auto Dial



1. Lift the **handset**.
2. Press the **Features** Key.
3. Press the **Dial Pad Number** Key for the Auto Dial position assigned to the number you want to call.  
The number dials automatically.

## Use Speed Call

To store a Speed Call Entry:



1. Without lifting the handset, press the **Features** Key.
2. Press the **Dial Pad Number** Key assigned to the Speed Call Controller feature. The Feature Activation Indicator flashes.
3. **Dial** a 1 to 3 digit Speed Call code (ask your network administrator for the number of digits required.)
4. **Dial** the number you want to program to the Speed Call code entered in the previous step.
5. Press the **Features** Key.



To make a Speed Call:



6. Press the **Dial Pad Number** Key for the Speed Call Controller feature.

1. Lift the **handset**.

2. Press the **Features** Key.

3. Press the **Dial Pad Number** Key for the Speed Call Controller feature or the Speed Call User feature.

4. **Dial** the Speed Call code of the number you want to call.

The Speed Call feature automatically dials the number.

## Use Call Transfer

To transfer an active call to a different telephone number follow these steps:

To use the Transfer feature:



1. Press the **Hold** Key to put the active call on hold.

**Note:** The previous step is not required if the Automatic Hold feature is active.

2. Press the **Features** Key.

3. Press the **Dial Pad Number** Key for the Transfer feature.

4. **Dial** the number where you want to transfer the call.

5. Press the **Features** Key when you hear ringing tone.



6. Press the **Dial Pad Number** Key for the Transfer feature.

**Note:** On the Meridian SL-100 use steps one to three then hang up. If you continue, a three way conversation is established.

## Use Conference Call feature

To add another party to an established call follow these steps:

**To use the Conference Call feature:**



1. Press the **Hold** Key to put the active call on hold.

**Note:** The previous step is not required if the Automatic Hold feature is active.



2. Press the **Features** Key.



3. Press the **Dial Pad Number** Key for the Conference feature.



4. **Dial** the number of the party you want to add to the call.



5. Press the **Features** Key.



6. Press the **Dial Pad Number** Key for the Conference feature.

**Note 1:** Repeat these step to add more parties to the conference (up to six).

**Note 2:** Press the **Goodbye** Key, if you make an error while dialing the number or if you receive a busy signal.

**To return to the original caller:**



Press the **Line** (DN) Key.

## Activate Ring Again

If you receive a busy tone or no answer when you try to reach someone in your private network, Ring Again gives you audible tone notification when that person is available or has used their telephone. The Ring Again feature allows you to automatically redial the number.

To activate the Ring Again feature:



To use Ring Again to call your party when you receive notification:



To cancel the Ring Again feature:



1. **Dial** a number and receive a busy tone or no answer.

**Note:** The Meridian SL-100 supports Ring Again on busy tone only.

2. Press the **Features** Key.
3. Press the **Dial Pad Number** Key for the Ring Again feature.
4. Replace the **handset**.

1. Lift the **handset**.
2. Press the **Features** Key.
3. Press the **Dial Pad Number** Key for the Ring Again feature. Ring Again dials the number.

1. Press the **Features** Key.
2. Press the **Dial Pad Number** Key for the Ring Again feature before you hear the Ring Again notification tone.



## Make a call

---

To dial a number while on-hook:



1. Press the **Line** (DN) Key.
2. **Dial** the number.
3. Lift the **handset** and speak when the party answers.



To use handset and dial number:



1. Lift the **handset**, the telephone automatically selects the Line (DN).
2. **Dial** the telephone number.



## Receive a call

---

To receive a call:



Lift the **handset** when the telephone rings and begin to talk.

## Feature Activation Indicator

---

The Feature Activation Indicator (FAI) serves all five programmable feature keys. The feature indicator LED winks or lights when a feature is active.

## Message Waiting and Call Status Indicator

---

The Message Waiting Indicator (MWI) provides three functions. the MWI flashes for an incoming call, the MWI also flashes to indicate a call on Hold. The MWI produces a steady light to indicate that a message is waiting. The MWI cannot show there is a message waiting if a call is on hold or if there is an incoming call.

## Accessories for the M3900 Series telephones

Optional items are available for use with your M3900 Series Digital telephone. Please contact your System Administrator for additional details.

**Note:** Wall attachment is available for all four models.

### Accessory Connection Module (ACM)

---

The Accessory Connection Module provides the interface for adding the Analog Terminal Adapter, External Alerter and Recorder Interface, and Meridian Communication Adapter. The ACM is available for the **M3902**, **M3903** and **M3904**.

### Analog Terminal Adapter (ATA)

---

The ATA allows you to connect an analog device such as a modem or fax machine to your telephone. The ATA is available for the **M3902**, **M3903**, and **M3904** models.

### External Alerter and Recorder Interface

---

The External Alerter Interface lets you connect a remote ringer to your telephone. The External Alerter and Recorder interface is available for the **M3902**, **M3903**, and **M3904** models.

### Headsets

---

An amplified and unamplified headset is compatible with your M3900 Series Meridian Digital Telephones. The amplified headset is an option for noisy environments.

Headsets vary in electrical, physical and audio characteristics. Performance perception is subjective so it is recommended that the headset user try using their headset with each of the three settings on both internal and external calls to determine which works best for them.

To adjust the headset volume, go to the Options menu, Headset types and select one of the headset types from the sub-menu item: Headset 1, Headset 2 or Amplified.

Refer to your distributor for the latest product bulletin from Nortel Networks for recommended headset types for the M3900 Series telephone.

### Key-based Expansion Module (KEM)

---

The KEM provides additional line (DN) or feature keys for the **M3904**. You can add up to two Key Expansion modules, for a total of 64 feature keys. The KEM is available only for the **M3904**.

## Meridian 1 Flexible Feature Codes (FFCs)

|  |                                 |  |                                |
|--|---------------------------------|--|--------------------------------|
|  | Radio Paging                    |  | Lock                           |
|  | Radio Paging Access             |  | Unlock                         |
|  | Radio Paging Answer             |  | Call Pick Up                   |
|  | Call Park                       |  | DN Pick Up                     |
|  | Electronic Lock Password Change |  | Group Pick Up                  |
|  | Maid ID                         |  | Remote Call Forward Activate   |
|  | Wake-Up Request                 |  | Remote Call Forward Verify     |
|  | Wake-Up Verify                  |  | Remote Call Forward Deactivate |
|  | Wake-Up Cancel                  |  | Trace                          |

## Meridian SL-100 Feature Access Codes (FACs)

|  |  |  |  |
|--|--|--|--|
|  | Account Code                                       |  | Make Set Busy (MSB)                                |
|  | Anonymous Caller Rejection (ACRJ)                  |  | Malicious Call Hold (MCH)                          |
|  | Automatic Callback (ACB)                           |  | Paging access code                                 |
|  | Automatic Recall (AR)                              |  | Random Make Busy (RMB)                             |
|  | Busy Override                                      |  | Secondary MADN Call Forwarding (CFMDN)             |
|  | Call Forward Busy/Don't Answer - Internal/External |  | Selective Call Forward (SCF)                       |
|  | Customer Originated Trace (COT)                    |  | SIM Ring   |
|  | Directory Call Park (DCPK)                         |  | System Call Park                                   |
|  | Directed Call Pick-up (DCPU)                       |  | Station Origination Restrictions Controller (SORC) |
|  | Executive Busy Override (EBO)                      |  | Station Specific AuthCode (SSAC)                   |
|  | Flexible Station Controlled Conference (CNF)       |  | Uniform Call Distribution (UCD)                    |
|  | Last Number Redial                                 |  | Wake-up Service                                    |

**A**

- access the Personal Directory **82**
- accessories **98**
- Accessory Connection Module (ACM) **98**
- account code **47**
- Analog Terminal Adapter (ATA) **98**
- announcement **46, 53**
- Area code setup **67**
- attendant **8**
- Attendant Recall **27**
- Auto Dial **18, 45, 92, 93**
  - display number **18**
- Auto Dial Transfer **45**
- Automatic Answerback **32**
- Automatic Hold **94, 95**
- Automatic Wake-Up **54**

**B**

- busy **44**
- Busy Override **50**
- buzz **45**

**C**

- Call Charge **47**
- Call Detail Recording **47, 48**
- Call Forward **35**
- Call Forwarding Remote FAC **36**
- call hold **25**
- Call indicator light **69**
- Call Join **40**
- Call Log **8, 15, 77**
  - access, M3904 **73**
- Call Log Key **7**
- Call Log options **65**
- Call Page **46**
- Call Park **28**
- Call Pickup **33**
- call status indication
  - M3901 **97**
- call timer **67**
- Call Trace **31**
- Call Transfer **94**
- call transfer **25**
- Call Waiting **34**

Callers List **77**M3903 **77**M3904 **78**Calling Line Identification (CLID) **8**Calling Party Number **30**

## camp-on

forced **49**Card View **88**card view **8**Centrex Switchhook Flash **45, 46**Centrex/Exchange Switchhook Flash **46**Charge Account, Forced **47**charge calls **47**Conference **31, 40, 41, 47, 95**copy from Redial List **89**Copy Key **6, 8****D**date format **67**Date/time display **8**Delete Key **7**Dial Key **6**

## Dial Tone

interrupted **8**dial tone, special **9**

## dialing

dial pad **18**on-hook **15, 18**predial **15**Direct Inward System Access **37**Directed Call Park (DCPK) Key **28**Directed Call Pickup **33**directory **73**password protection **74**Directory Number (DN) **8, 56, 58**Directory Number (DN) Key **6**Directory/Log Key **7, 74, 82**

## display

M3902 **59**M3903 **59**M3904 **60**Display diagnostics **70**Display Key **30**

- DN **8**
- Done Key **6, 61**
- E**
- Edit Key **7**
- Electronic Lock **38**
- Electronic Lock password **37, 38**
- Enhanced Override **49**
- External Alerter and Recorder Interface **98**
- F**
- Feature Access Code (FAC) **8, 33, 36**
- Feature Access Codes (FAC) **100**
- Feature Activation Code (FAC) **10, 29, 36, 50, 54**
- Feature Activation Indicator (FAI),M3901 **97**
- Feature Key
  - change label **62**
  - feature operation
    - M3901 **90**
- Features Key, M3901 **91**
- Fixed Keys **8**
- Flexible Feature Code (FFC) **8, 10, 29, 37, 38, 47, 48, 50, 54, 99**
- Forced Camp-on **49**
- forward calls
  - all calls **35**
  - internal calls **35**
  - remote activation **36**
- G**
- Goodbye Key **5, 10, 90**
- Group Call **42**
- Group Intercom **53**
- Group Listening **12**
- Group listening **71**
- H**
- handsfree **5, 10**
- Handsfree Key **5, 10**
- headset **11**
- Headset Key **5, 11**
- Headset port external alerter **69**
- Headset port on call **68**
- Headsets **98**
- Hold **25, 34**
- Hold Key **5, 90**
- hookswitch **9**
- Hospitality features **54**
- Hot Line **22**
- I**
- indicator **8**
- Information display **8**
- Information line **8**
- Intercom **23**
- Internal Call Forward **35**
- Interrupted dial tone **8**
- J**
- join a call **40**
- K**
- key click **68**
- key layout
  - M3901 **1**
  - M3902 **2**
  - M3903 **3**
  - M3904 **4**
- Key-based Expansion Module **98**
- keys
  - Call Log **7**
  - Copy Key **6, 8**
  - Delete Key **7**
  - Dial Key **6**
  - Directory/Log Key **7, 74, 82**
  - Display Key **30**
  - Done Key **6, 61**
  - Edit Key **7**
  - Feature Key **62**
  - Features Key, M3901 **91**
  - Fixed Keys **8**
  - Goodbye Key **5, 10, 90**
  - Handsfree Key **5, 10**
  - Headset Key **5, 11**
  - Hold Key **5, 90**
  - Line (DN) Key **5, 6**
  - Line (DN) Key,M3901 **91**
  - M3901 keys **90**
  - More... Key **7, 9**
  - Mute Key **5, 10**

Navigation Keys **6, 61**  
 Options Key **6, 61**  
 Primary Directory Number (PDN)  
 Key **6**  
 Programmable Line (DN)/Feature  
 Key **7, 62**  
 Programmable Soft Keys **7**  
 Quit Key **6, 61**  
 Select Key **61**  
 Shift Key **7**  
 Volume Control Bar **5, 91**

**L**

language selection **62**  
 Last Number Redial **20**  
 Line (DN) Key **1, 2, 5, 31, 91**  
 Line Key **6**  
 live dial pad **66**  
 Lock FFC **38**

**M**

M3901  
 feature operation **90**  
 fixed keys **90**  
 key layout **1**  
 M3901 Features  
 Auto Dial **92, 93**  
 call status indication **97**  
 Call Transfer **94**  
 Conference **95**  
 Feature Activation Indicator  
 (FAI) **97**  
 make a call **97**  
 Message Waiting Indicator  
 (MWI) **97**  
 receive calls **97**  
 Ring Again **96**  
 Speed Call **93**  
 M3902  
 display **59**  
 key layout **2**  
 Options List **61**  
 M3903  
 Callers List **77**  
 display **59**

key layout **3**  
 Options List **61**  
 Redial List **80**  
 M3904  
 Callers List **78**  
 Directories **73**  
 display **60**  
 key layout **4**  
 Options List **61**  
 Personal Directory **82**  
 Personal Directory, access **73**  
 Redial List **80, 89**  
 Maid Identification **57**  
 make a call  
 M3901 **97**  
 Make Set Busy **44**  
 Malicious Call Hold (MCH) **31**  
 malicious call trace **31**  
 Meridian 1 **8**  
 Meridian SL-100 **10, 18, 19, 20, 22,**  
**25, 26, 27, 28, 29, 30, 31, 33, 36,**  
**42, 45, 47, 50, 51, 53, 54, 95, 96**  
 Message Registration **56**  
 Message Waiting Indicator  
 (MWI),M3901 **97**  
 More... Key **7**  
 More... Keys **9**  
 Multiple Appearance Directory  
 Number (MADN) **9, 51**  
 mute **10**  
 Mute Key **5, 10**  
**N**  
 Navigation Keys **6, 61**  
**O**  
 off-hook **9**  
 On-hook default path **70**  
 on-hook dialing **15, 18**  
 Options Key **6, 61**  
 Options List **61**  
 Override **50**  
 override  
 enhanced **49**

**P**

- page **46, 51**
- “Meet - me” page **51**
- paging tone **9**
- park **28**
- password
  - directory **74**
- Personal Directory **9, 74, 82, 89**
  - Card View **88**
  - delete directory **87**
  - delete entries **86**
  - edit entries **86**
  - make calls from directory **87**
  - search **88**
- pickup **33**
- Predial **15**
- preferred name match **66**
- Preset Conference **42**
- Primary Directory Number (PDN) **9**
- Primary Directory Number (PDN) Key **6**
- Privacy Release **51**
- Private Line **9**
- Programmable Line (DN)/Feature Key **3, 4, 7, 62, 63**
- Programmable Soft Keys **2, 3, 4, 7**

**Q**

Quit Key **6, 61**

**R**

- Radio Page **51**
- recall
  - attendant **27**
  - Timed Reminder Recall **26**
- receive calls
  - M3901 **97**
- Redial **20**
- redial **96**
- Redial List **9, 77, 80, 89**
  - access, M3904 **73**
  - M3903 **14, 80**
  - M3904 **14, 80**
- Redial list on the M3904 **14**
- Remote Access Directory Number **36**

- Remote Call Forward **36**
- Remote Call Forward FFC **37**
- Ring Again **19**
  - M3901 **96**
- ring tone **9, 50**
- ring type **65**
- ringback **9, 50**
- Ringback/ring tone **8**
- Room Status **58**

**S**

- screen contrast **64**
- secure your telephone **38**
- Select Key **61**
- Selectable Conferee Display and Disconnect **41**
- shared Directory Number (DN) **9**
- Shift Key **7**
- special dial tone **9**
- Special Prefix (SPRE) code **29**
- Special Prefix code **47, 48**
- Speed Call **21, 93**
- Speed Call Controller **21, 94**
- Speed Call User **94**
- Speed Call, System **22**
- SPRE code **47, 48**
- Switchhook **7**
- switchhook **9**
- System Park DN **28, 29**
- System Speed Call **22**

**T**

- time
  - format **67**
  - wake-up **54**
- Timed Reminder Recall **26**
- Trace **31**
- Transfer **25, 31, 47**
- transfer **94**

**V**

- Voice Call **53**
- Volume Control Bar **5, 91**
- volume, adjust **64**

**W**

- work without interruption **44**





Title to and ownership of Meridian SL-1 software shall at all times remain with Nortel Networks. Meridian SL-1 software shall not be sold outright and the use thereof by the customer shall be subject to the parties entering into software agreements as specified by Nortel Networks.

Information contained in this document is subject to change. Nortel Networks reserves the right, without notice, to make changes in equipment design or program components as progress in engineering, manufacturing or technology may warrant.

Reordering number: NT2F7901 A0779727  
(c/o 15 each per package P0903627)

Internal Manufacturing part number:  
P0903627  
Issue 2.00

Printed in the United States of America  
February 1999

[www.nortelnetworks.com](http://www.nortelnetworks.com)

**NORTEL**  
NETWORKS